



Sorensen

**Asterion DC Multi Output
ASA Series
Operation Manual**

About AMETEK

AMETEK Programmable Power, Inc., a unit of AMETEK Electronic Instruments Group (a division of AMETEK, Inc.), is a global leader in the design and manufacture of precision, programmable power supplies for R&D, test and measurement, process control, power bus simulation and power conditioning applications across diverse industrial segments. Offering bench-top supplies to rack mounted industrial power subsystems, AMETEK Programmable Power is the proud manufacturer of Elgar, Sorensen, California Instruments, Power Ten, and Amrel brand power supplies and electronic loads.

AMETEK, Inc. is a leading global manufacturer of electronic instruments and electromechanical devices with annualized sales of \$5 billion. The company has over 14,000 colleagues working at more than 120 manufacturing facilities and more than 80 sales and service centers in the United States and around the world.

Trademarks

AMETEK is a registered trademark of AMETEK, Inc. Sorensen is a trademark owned by AMETEK, Inc. Other trademarks, registered trademarks, and product names are the property of their respective owners and are used herein for identification purposes only.

Notice of Copyright

M330516-01 Asterion DC Multi output ASA Series Operation Manual © 2021, AMETEK Programmable Power, Inc., All rights reserved.

Exclusion for Documentation

- UNLESS SPECIFICALLY AGREED TO IN WRITING, AMETEK PROGRAMMABLE POWER, INC. ("AMETEK"):
- (a) MAKES NO WARRANTY AS TO THE ACCURACY, SUFFICIENCY OR SUITABILITY OF ANY TECHNICAL OR OTHER INFORMATION PROVIDED IN ITS MANUALS OR OTHER DOCUMENTATION.
 - (b) ASSUMES NO RESPONSIBILITY OR LIABILITY FOR LOSSES, DAMAGES, COSTS OR EXPENSES, WHETHER SPECIAL, DIRECT, INDIRECT, CONSEQUENTIAL OR INCIDENTAL, WHICH MIGHT ARISE OUT OF THE USE OF SUCH INFORMATION. THE USE OF ANY SUCH INFORMATION WILL BE ENTIRELY AT THE USER'S RISK, AND
 - (c) REMINDS YOU THAT IF THIS MANUAL IS IN ANY LANGUAGE OTHER THAN ENGLISH, ALTHOUGH STEPS HAVE BEEN TAKEN TO MAINTAIN THE ACCURACY OF THE TRANSLATION, THE ACCURACY CANNOT BE GUARANTEED. APPROVED AMETEK CONTENT IS CONTAINED WITH THE ENGLISH LANGUAGE VERSION, WHICH IS POSTED AT WWW.PROGRAMMABLEPOWER.COM.

Date and Revision

23-Mar-26, Rev G

Part Number

M330516-01

Contact Information

Telephone: 800 733 5427 (toll free in North America)
858 450 0085 (direct)
Fax: 858 458 0267
Email: sales.ppd@ametek.com
service.ppd@ametek.com
Web: www.programmablepower.com

Product Family: Asterion DC Multioutput ASA Series

Warranty Period: Five Years

Warranty Terms

AMETEK Programmable Power, Inc. (“AMETEK”), provides this written warranty covering the Product stated above, and if the Buyer discovers and notifies AMETEK in writing of any defect in material or workmanship within the applicable warranty period stated above, then AMETEK may, at its option: repair or replace the Product; or issue a credit note for the defective Product; or provide the Buyer with replacement parts for the Product.

The Buyer will, at its expense, return the defective Product or parts thereof to AMETEK in accordance with the return procedure specified below. AMETEK will, at its expense, deliver the repaired or replaced Product or parts to the Buyer. Any warranty of AMETEK will not apply if the Buyer is in default under the Purchase Order Agreement or where the Product or any part thereof:

- is damaged by misuse, accident, negligence, or failure to maintain the same as specified or required by AMETEK;
- is damaged by modifications, alterations, or attachments thereto which are not authorized by AMETEK;
- is installed or operated contrary to the instructions of AMETEK;
- is opened, modified, or disassembled in any way without AMETEK’s consent; or
- is used in combination with items, articles or materials not authorized by AMETEK.

The Buyer may not assert any claim that the Products are not in conformity with any warranty until the Buyer has made all payments to AMETEK provided for in the Purchase Order Agreement.

Product Return Procedure

1. Request a Return Material Authorization (RMA) number from the repair facility (**must be done in the country in which it was purchased**):
 - **In the USA**, contact the AMETEK Repair Department prior to the return of the product to AMETEK for repair:
 - Telephone: 800-733-5427, ext. 2295 or ext. 2463 (toll free North America)
858-450-0085, ext. 2295 or ext. 2463 (direct)
 - **Outside the United States**, contact the nearest Authorized Service Center (ASC). A full listing can be found either through your local distributor or our website, www.powerandtest.com, by clicking Support and going to the Service Centers tab.
2. When requesting an RMA, have the following information ready:
 - Model number
 - Serial number
 - Description of the problem

Note: Unauthorized returns will not be accepted and will be returned at the shipper’s expense.

Note: A returned product found upon inspection by AMETEK, to be in specification is subject to an evaluation fee and applicable freight charges.

IMPORTANT SAFETY INSTRUCTIONS

Before applying power to the system, verify that your product is configured properly for your application.



WARNING!

Hazardous voltages might be present when covers are removed. Qualified personnel must use extreme caution when servicing this equipment. Circuitry, test points, and output voltages might be floating with respect to chassis ground. Do not touch electrical circuits and use appropriately rated test equipment. A safety ground wire must be connected from the chassis to the AC mains input when servicing this equipment.



WARNING!

This equipment contains ESD sensitive input/output connection ports. When installing equipment, follow ESD safety procedures. Electrostatic discharges might cause damage to the equipment.

Only qualified personnel, who understand and deal with attendant hazards in power supplies, can perform installation and servicing.

Ensure that the AC mains input ground is connected properly to the chassis safety ground connection. Similarly, other power ground lines, including those to application and maintenance equipment, must be grounded properly for both personnel and equipment safety. Always ensure that facility AC mains input is de-energized prior to connecting or disconnecting any cable.

In normal operation from the front panel, the operator does not have access to hazardous voltages within the chassis. However, depending on the application configuration, **HIGH VOLTAGES HAZARDOUS TO HUMAN SAFETY** might be normally generated on the output terminals. The user must ensure that the output power lines are labeled properly as to the safety hazards and that any possibility for inadvertent contact with hazardous voltages is eliminated.

Guard against risks of electrical shock during open cover checks by not touching any portion of the electrical circuits. Even when power is off, capacitors may retain an electrical charge. Use safety glasses during open cover checks to avoid personal injury by any sudden component failure.

Neither AMETEK Programmable Power Inc., San Diego, California, USA, or any of the subsidiary sales organizations, can accept any responsibility for personnel, material or inconsequential injury, loss or damage that results from improper use of the equipment and accessories.

SAFETY SYMBOLS



WARNING: Electrical Shock Hazard



HAZARD: Strong oxidizer



GENERAL WARNING/CAUTION: Read the accompanying message for specific information.



BURN HAZARD: Hot Surface Warning. Allow to cool before servicing.



DO NOT TOUCH: Touching some parts of the instrument without protection or proper tools could result in damage to the part(s) and/or the instrument.



TECHNICIAN SYMBOL: All operations marked with this symbol are to be performed by qualified maintenance personnel only.



ELECTRICAL GROUND: This symbol inside the instrument marks the central safety grounding point for the instrument.

FCC NOTICE

This equipment has been tested and found to comply with the limits for a Class A digital device, pursuant to part 15 of the FCC Rules. These limits are designed to provide reasonable protection against harmful interference when the equipment is operated in a commercial environment.

This equipment generates, uses, and can radiate radio frequency energy and, if not installed and used in accordance with the instruction manual, may cause harmful interference to radio communications. Operation of this equipment in a residential area is likely to cause harmful interference in which case the user will be required to correct the interference at his own expense.

ABOUT THIS MANUAL AND REGULATORY COMPLIANCE

This manual has been written for the Asterion DC Multioutput Series of power supplies, which have been designed and certified to meet the Low Voltage, Electromagnetic Compatibility, and RoHS Directives per the requirements of the European Community.

These models have been designed and tested to meet the Electromagnetic Compatibility Directive 2014/30/EU, and the Low Voltage Directive 2014/35/EU. In addition, these models have been found compliant with FCC 47 CFR Part 15, Subpart B, 107(b) Class A, 109(g) Class A.

Since the Low Voltage Directive is to ensure the safety of the equipment operator, universal graphic symbols have been used both on the unit itself and in this manual to warn the operator of potentially hazardous situations (see Safety Instructions page).

Contents

1	OVERVIEW.....	1-1
1.1	General Description	1-1
1.2	Specifications.....	1-5
1.2.1	Output Power.....	1-5
1.2.2	ASA Series Output Voltage and Current Ratings.....	1-5
1.2.3	Resolution Specifications	1-9
1.2.4	Remote Sense	1-9
1.2.5	DC Output Programming, Readback and Regulation Specifications ⁽¹⁾⁽²⁾	1-10
1.2.6	Output Ripple, Noise and Transient Specifications	1-11
1.2.7	AC Input Specifications	1-11
1.2.8	Operational Characteristics	1-14
1.2.9	Front Panel Controls/Indicators	1-15
1.2.10	Remote Isolated External User Control I/O Signal Interface Characteristics.....	1-15
1.2.11	Remote Control Digital Interface Characteristics	1-16
1.2.12	Optional Remote Isolated Analog Programming Interface Characteristics ..	1-17
1.2.13	Protection Function Characteristics.....	1-17
1.2.14	Output Isolation.....	1-18
1.2.15	Environmental Specifications	1-18
1.2.16	Mechanical Specifications	1-18
1.2.17	Regulatory Agency Compliance	1-19
1.2.18	Rear Panel Connectors	1-19
1.2.19	Overall Dimensions Drawing	1-21
2	INSTALLATION.....	2-1
2.1	Inspection	2-1
2.2	Contents of Shipment	2-1
2.3	Mechanical Installation	2-2
2.4	Brackets and Handles	2-3
2.5	Rack Mounting	2-4
2.6	Chassis Removal from Rack	2-6
2.7	Outline drawings	2-6
2.8	Rear Panel Input/ Output Connections	2-9
2.9	AC input power connection.....	2-10
2.9.1	AC input overcurrent protection.....	2-10
2.9.2	AC Input Safety Disconnect Device.....	2-11
2.9.3	AC Input Connector	2-11

2.9.4	1-Phase AC Input Operation- Only Supported in Input AC voltage type “C”	2-13
2.9.5	3-Phase AC Input Operation	2-13
2.10	DC Output and Remote Sense power connections	2-14
2.11	Wire Gauge Selection	2-16
2.11.1	Wire Size	2-16
2.12	Load Considerations	2-18
2.12.1	Inductive and Stored-Energy Loads	2-18
2.13	Rear Panel User Interface Connectors	2-19
2.13.1	Remote Analog programming	2-19
2.13.2	Remote External user control interface	2-22
2.13.3	RS-232C Serial Interface	2-27
2.13.4	USB interface	2-28
2.13.5	LAN interface	2-29
2.13.6	GPIB interface	2-30

3 OPERATION 3-32

3.1	Introduction	3-32
3.2	Front Panel Controls and LED Indicators	3-32
3.3	Basic Front Panel Operation	3-33
3.3.1	Initial Setup	3-34
3.3.2	Front Panel Touch Screen Layout	3-34
3.3.3	Navigation and Selection	3-35
3.3.4	Touch-Screen Numeric Keypad	3-37
3.3.5	Rotary Encoder	3-37
3.4	Front Panel Display Menu and Functionality	3-40
3.4.1	Power-Up Screens	3-40
3.4.2	Home Screen Top-Level Menu	3-41
3.4.3	Dashboard Screen Top-Level Menu	3-42
3.4.4	Output Program	3-46
3.4.5	Measurements	3-50
3.4.6	Configuration Screen	3-51
3.4.7	Ramp	3-67
3.4.8	Output On/Off Delay	3-74
3.4.9	Control Interface Screen	3-78
3.4.10	System Settings Screen	3-88
3.4.11	Warning/Fault Screen	3-92
3.4.12	Local/Remote Screen	3-94
3.5	Output Verification	3-94
3.5.1	Constant-Voltage Mode Operation	3-94

3.5.2	Constant-Current Mode Operation	3-95
3.5.3	Overvoltage Protection	3-96
3.5.4	Constant-Power Mode	3-97

4 REMOTE EXTERNAL USER INTERFACE

CONTROL..... 4-1

4.1	Introduction	4-1
4.2	Remote Inhibit (Switch/Relay Contact Closure).....	4-5
4.3	Remote Output ON/OFF Control by External Source.....	4-7
4.4	Trigger Functions.....	4-9
4.4.1	Voltage Ramp	4-9
4.4.2	Current Ramp	4-9
4.5	Fault Status.....	4-11
4.6	Regulation Mode Status.....	4-12
4.7	Output ON/OFF Status	4-13

5 REMOTE ANALOG PROGRAMMING INTERFACE

CONTROL..... 5-1

5.1	Introduction	5-1
5.2	Remote Analog Isolated Interface Control	5-1
5.3	Remote Current Programming	5-4
5.3.1	Remote Current Programming by Resistance.....	5-4
5.3.2	Remote Current Programming by Voltage Source	5-6
5.4	Remote Voltage Programming	5-8
5.4.1	Remote Voltage Programming by Resistance	5-8
5.4.2	Remote Voltage Programming by Voltage Source.....	5-9
5.5	Voltage Monitor (VMON)	5-11
5.6	Current Monitor (IMON).....	5-11

6 CALIBRATION AND VERIFICATION 6-1

6.1	Introduction	6-1
6.1.1	Calibration and Verification Cycle.....	6-1
6.1.2	Digital programming and readback calibration	6-1
6.1.3	Analog control interface calibration (Standard and Isolated analog interface).....	6-1

7	MAINTENANCE.....	7-1
7.1	Introduction	7-1
7.2	Preventive Maintenance.....	7-1

LIST OF TABLES

Table 1-1: Voltage Model for ASA series	1-4
Table 1-2: Output Power for ASA Series.....	1-5
Table 1-3: Channel ratings for Asterion DC Multioutput ASA Model Series.....	1-5
Table 2-1: Ship Kit Details.....	2-2
Table 2-2: Rear Panel Connector.....	2-10
Table 2-3: Maximum Input Line Current.....	2-10
Table 2-4: AC Input Connector Pinout and Safety-Ground.....	2-12
Table 2-5: AC Input Connector Type.....	2-12
Table 2-6: DC Output and Remote Sense Connector Pinout	2-14
Table 2-7: DC Output and Remote Sense Connector Type.....	2-15
Table 2-8: Minimum Wire Size	2-17
Table 2-9: Wire Resistance and Voltage Drop, 20°C	2-18
Table 2-10: Analog Programming Connector Type	2-20
Table 2-11: Analog Programming Connector Characteristics.....	2-20
Table 2-12: Analog Programming Connector Pin out	2-22
Table 2-13: External User Control Interface connector Type.....	2-22
Table 2-14: External User Control Interface Characteristics.....	2-23
Table 2-15: External User Control Interface Pin Out details	2-27
Table 2-16: RS-232C Interface Connector Type	2-28
Table 2-17: RS-232C Interface Connector Pinout.....	2-28
Table 2-18: USB Interface Connector Type	2-29
Table 2-19: USB Interface Connector Pinout	2-29
Table 2-20: LAN Interface Connector Type.....	2-29
Table 2-21: LAN Interface 8P8C Modular Connector Pinout	2-30
Table 2-22: GPIB Interface Connector Type	2-30
Table 2-23: GPIB Interface Connector Pinout.....	2-31
Table 3-1: Front Panels controls and indicators	3-33
Table 3-2: Home Screen Menu Content.....	3-42
Table 3-3: Fault Conditions.....	3-93
Table 4-1: External user interface control connector pin out details	4-5
Table 5-1: Analog Programming Connector, Designations and Functions.....	5-3

LIST OF FIGURES

Figure 1-1: Asterion DC Series Power Supply, 1U Models.....	1-1
Figure 1-2: Asterion DC Multioutput ASA Series Model Number Decoding	1-3
Figure 1-3 ASA Series Extended Wide Range Channels Voltage Vs Current Characteristics	1-6
Figure 1-4 ASA Series 600W, 60 V, 42 A Voltage Vs Current Characteristics.....	1-7
Figure 1-5 ASA Series 600 W, 200 V, 17 A Voltage Vs Current Characteristics.....	1-7
Figure 1-6 ASA Series 600 W, 80 V, 22 A Voltage Vs Current Characteristics.....	1-8
Figure 1-7 ASA Series 600 W, 400 V, 6 A Voltage Vs Current Characteristics.....	1-8
Figure 1-8 ASA Series 600 W, 400 V, 6 A Voltage Vs Current Characteristics.....	1-9
Figure 1-9: Front Panel Display, Controls, and indicators	1-15
Figure 1-10: Rear Panel Connectors with GPIB Option.....	1-20
Figure 1-11 Dimensional Drawing	1-21
Figure 2-1: Brackets and Handles mounting, 1U Models	2-4
Figure 2-2 Rack mounting, 1U Multi output Asterion DC Series Model.....	2-5
Figure 2-3: Installation Drawing	2-7
Figure 2-4: Rear Panel View with GPIB option.....	2-8
Figure 2-5: Rear Panel Protective covers installation	2-8
Figure 2-6: AC Input Connector and Safety-Ground Stud	2-11
Figure 2-7: AC Input Connector wiring	2-11
Figure 2-8: Output and Remote Sense Connector of each channel	2-14
Figure 2-9: DC Output and Remotes Sense Connector wiring	2-15
Figure 2-10: Diode Connections.....	2-19
Figure 2-11: Analog Programming connector.....	2-20
Figure 2-12: External User Control Interface connector	2-22
Figure 2-13: RS-232C Interface Connector	2-28
Figure 2-14: USB Interface Connector	2-29
Figure 2-15: LAN Interface 8P8C Modular Connector	2-29
Figure 2-16: GPIB interface Connector	2-30
Figure 3-1: Front panel DC-Asterion Multioutput Series	3-32
Figure 3-2: Dashboard screen	3-34
Figure 3-3: Dashboard screen with channel 3 layout grayed out.....	3-35
Figure 3-4: Measurement screen	3-35
Figure 3-5: Measurement screen with Channel 3 layout grayed out.....	3-35
Figure 3-6: Home Screen with Dashboard Icon Highlighted	3-36
Figure 3-7: Dashboard Screen with Home Button Selected	3-36
Figure 3-8: Dashboard Screen with Channel-1 selected	3-36
Figure 3-9: Touch-Screen Numeric Keypad	3-36
Figure 3-10: DASHBOARD Screen Current Selection-Field Active using Encoder switch	3-37
Figure 3-11: Touch-Screen Numeric Keypad	3-37
Figure 3-12: Rotary Encoder.....	3-38

Figure 3-13: Splash Screen	3-40
Figure 3-14: Power-On Screen Displaying Model & Version	3-40
Figure 3-15: Output-Enabled Warning Screen	3-40
Figure 3-16: Abort Status Screen.....	3-41
Figure 3-17: HOME Screen Menu 1	3-41
Figure 3-18: HOME Screen Menu 2.....	3-41
Figure 3-19: HOME Screen Menu 3.....	3-41
Figure 3-20: Dashboard Screen – Channel 1	3-43
Figure 3-21: Dashboard Screen – Channel 2.....	3-43
Figure 3-22: Dashboard Screen – Channel 3.....	3-43
Figure 3-23: Output Voltage as EXT Reference Mode for Channel 1	3-44
Figure 3-24: Output Current as EXT Reference Mode for Channel 2	3-44
Figure 3-25: Output Voltage and current as EXT Reference Mode for Channel 3	3-44
Figure 3-26: Real-Time, Immediate Output Parameter Adjustment.....	3-45
Figure 3-27: Touch-Screen Numeric Keypad	3-45
Figure 3-28: Default Screen	3-46
Figure 3-29: OUTPUT PROGRAM Screen Top-Level Menu	3-46
Figure 3-30: Output Settings Screen – Channel 1.....	3-47
Figure 3-31: Output Settings Screen – Channel 2.....	3-47
Figure 3-32: Output Settings Screen – Channel 3.....	3-47
Figure 3-33: Output State Screen – Channel 1	3-48
Figure 3-34: Output State Screen – Channel 2	3-48
Figure 3-35: Output State Screen – Channel 3	3-48
Figure 3-36: Regulation Mode Screen – Channel 1	3-49
Figure 3-37: Regulation Mode Screen – Channel 2	3-49
Figure 3-38: Regulation Mode Screen – Channel 3	3-49
Figure 3-39: Output Sense Screen.....	3-50
Figure 3-40: Measurements Screen Top Level Menu.....	3-51
Figure 3-41: Configuration Menu screen 1	3-51
Figure 3-42: Configuration Menu screen 1 without Analog interface feature	3-51
Figure 3-43: Configuration Menu screen 2	3-52
Figure 3-44: Measurement Settings Screen.....	3-52
Figure 3-45: Remote Inhibit Screen channel 1	3-53
Figure 3-46: Remote Inhibit Screen channel 2	3-53
Figure 3-47: Remote Inhibit Screen channel 2	3-53
Figure 3-48: User V/I Limit Screen – Channel 1	3-54
Figure 3-49: User V/I Limit Screen – Channel 2	3-54
Figure 3-50: User V/I Limit Screen – Channel 3	3-55
Figure 3-51: Current Reference Mode channel 1	3-55
Figure 3-52: Current Reference Mode channel 2	3-55
Figure 3-53: Current Reference Mode channel 3	3-56
Figure 3-54: Voltage Ref Mode channel 1.....	3-56

Figure 3-55: Voltage Ref Mode channel 2.....	3-56
Figure 3-56: Voltage Ref Mode channel 3.....	3-57
Figure 3-57: Output On-Off Delay enable screen.....	3-57
Figure 3-58: PONS Menu Screen–1.....	3-58
Figure 3-59: PONS Menu Screen–2.....	3-58
Figure 3-60: PONS Menu Screen-1 without Analog Interface feature.....	3-58
Figure 3-61: PONS Menu Screen-2 without Analog Interface feature.....	3-58
Figure 3-62: PONS - Output Settings Screen.....	3-59
Figure 3-63: PONS - Output State Screen.....	3-60
Figure 3-64: PONS - Regulation Mode Screen.....	3-60
Figure 3-65: PONS - User V/I Limits Screen – Channel 1.....	3-61
Figure 3-66: PONS - User V/I Limits Screen – Channel 2.....	3-61
Figure 3-67: PONS - User V/I Limits Screen – Channel 3.....	3-61
Figure 3-68: PONS – Voltage Ref Mode channel – 1.....	3-62
Figure 3-69: PONS – Current Ref Mode Channel – 1.....	3-62
Figure 3-70: PONS - Analog Screen.....	3-63
Figure 3-71: PONS - Reference Source Settings Screen channel-1.....	3-63
Figure 3-72: PONS - Reference Source Settings Screen channel-2.....	3-63
Figure 3-73: PONS - Reference Source Settings Screen channel-3.....	3-63
Figure 3-74: PONS – Configure Reference Source channel - 1.....	3-64
Figure 3-75: PONS – Configure Full Scale Value Channel-1.....	3-64
Figure 3-76: PONS – Configure Full Scale Value Channel-2.....	3-65
Figure 3-77: PONS – Configure Full Scale Value Channel-3.....	3-65
Figure 3-78: PONS - Measurement Settings Screen.....	3-66
Figure 3-79: PONS – Remote Inhibit channel 1.....	3-66
Figure 3-80: PONS – Remote Inhibit channel 2.....	3-66
Figure 3-81: PONS – Remote Inhibit channel 3.....	3-67
Figure 3-82: Ramp Menu Screen.....	3-67
Figure 3-83: Voltage Ramp Screen.....	3-68
Figure 3-84: Ramp-Screen (Initialization).....	3-68
Figure 3-85: Voltage Ramp-Screen (SW Trigger).....	3-69
Figure 3-86: Voltage Ramp-Screen (HW Trigger).....	3-69
Figure 3-87: Voltage Ramp-Screen (Abort).....	3-69
Figure 3-88: Current Ramp Screen.....	3-71
Figure 3-89: Ramp-Screen (Initialization).....	3-71
Figure 3-90:- Current Ramp-Screen (SW Trigger).....	3-72
Figure 3-91: Current Ramp-Screen (HW Trigger).....	3-72
Figure 3-92: Current Ramp-Screen (Abort).....	3-73
Figure 3-93: Output ON/OFF delay Menu screen.....	3-74
Figure 3-94: Output On/Off Settings screen.....	3-74
Figure 3-95: Configure Output Condition screen.....	3-75
Figure 3-96: Configure Reference Channel screen.....	3-75

Figure 3-97: Warning screen 1.....	3-75
Figure 3-98: Warning screen 2.....	3-76
Figure 3-99: Output ON Delay graph	3-77
Figure 3-100: Delay settings screen.....	3-77
Figure 3-101: Control Interface Menu Screen	3-78
Figure 3-102: Control Interface Menu Screen with GPIB disabled.....	3-79
Figure 3-103: Control Interface Menu Screen with Analog disabled	3-79
Figure 3-104: RS232 Home Screen	3-79
Figure 3-105: RS232 Setting Screen	3-80
Figure 3-106: RS232 Configure Screen	3-80
Figure 3-107: LAN Menu Screen.....	3-80
Figure 3-108: LAN Screen (Settings)	3-81
Figure 3-109: LAN Screen DHCP disabled (Configure).....	3-81
Figure 3-110:LAN Screen DHCP enabled (Configure).....	3-81
Figure 3-111: LAN Screen (DHCP)	3-81
Figure 3-112: LAN Screen (Auto IP)	3-82
Figure 3-113: LAN Screen (Host Name)	3-82
Figure 3-114: LAN Screen (Port).....	3-82
Figure 3-115: LAN Screen (IP Address).....	3-82
Figure 3-116: LAN Screen (Subnet Mask)	3-83
Figure 3-117: LAN Screen (Gateway Address)	3-83
Figure 3-118: LAN Screen (Restore Default).....	3-83
Figure 3-119: LAN Screen (Apply)	3-84
Figure 3-120: Analog Screen	3-84
Figure 3-121: Reference Source Settings -Channel 1	3-84
Figure 3-122: Reference Source Settings – Channel 2	3-85
Figure 3-123: Reference Source Settings – Channel 3	3-85
Figure 3-124: Configure Reference Source– Channel 1.....	3-85
Figure 3-125: Configure Reference Source – Channel 2.....	3-86
Figure 3-126: Configure Reference Source – Channel 3.....	3-86
Figure 3-127: Configure Full Scale Value screen channel-1.....	3-87
Figure 3-128: Configure Full Scale Value screen channel-1.....	3-87
Figure 3-129: Configure Full Scale Value screen channel-2.....	3-87
Figure 3-130: Configure Full Scale Value screen channel-3.....	3-87
Figure 3-131: USB Screen	3-88
Figure 3-132: GPIB address setting Screen.....	3-88
Figure 3-133: System Settings Menu Screen	3-89
Figure 3-134: System Settings Screen (channel 1 Status)	3-89
Figure 3-135: System Settings Screen (channel 2 Status)	3-89
Figure 3-136: System Settings Screen (channel 3 Status)	3-89
Figure 3-137: System Settings Screen (Version)	3-90
Figure 3-138: System Settings Screen (Hardware Limits).....	3-90

Figure 3-139: System Settings Screen (LCD Settings).....	3-90
Figure 3-140: System Settings Screen (LCD Settings) Brightness	3-91
Figure 3-141: System Settings Screen (LCD Settings) Calibration.....	3-91
Figure 3-142: System Settings Screen (Default Screen Enabled)	3-91
Figure 3-143: System Settings Screen (Factory Default)	3-92
Figure 3-144: Fault Screen	3-92
Figure 3-145: Clear Fault Screen	3-92
Figure 3-146: Local/Remote Screen	3-94
Figure 3-147: Constant-Power Example	3-97
Figure 4-1: External User Interface Connector	4-1
Figure 4-2: Output On/Off Control by Contact Closure channel 1.....	4-6
Figure 4-3: Output On/Off Control by Contact Closure channel 2.....	4-6
Figure 4-4: Output On/Off Control by Contact Closure channel 3.....	4-6
Figure 4-5: Remote Inhibit Mode.....	4-7
Figure 4-6: Remote Inhibit Clear Fault Screen	4-7
Figure 4-7: Remote Output On/Off Using DC Source Channel 1.....	4-8
Figure 4-8: Remote Output On/Off Using DC Source Channel 2.....	4-8
Figure 4-9: Remote Output On/Off Using DC Source Channel 3.....	4-8
Figure 4-10: Trigger Input for channel 1	4-10
Figure 4-11: Trigger Input for channel 2.....	4-10
Figure 4-12: Trigger Input for channel 3.....	4-10
Figure 4-13: Fault Status Channel 1	4-11
Figure 4-14: Fault Status Channel 2	4-11
Figure 4-15: Fault status Channel 3	4-12
Figure 4-16: Regulation mode status channel 1	4-12
Figure 4-17: Regulation mode status channel 2.....	4-13
Figure 4-18: Regulation mode status channel 3	4-13
Figure 4-19: Output ON/OFF Status channel 1	4-13
Figure 4-20: Output ON/OFF Status channel 2	4-14
Figure 4-21: Output ON/OFF Status channel 3	4-14
Figure 5-1: Analog Control connector	5-2
Figure 5-2: Current Reference Mode	5-4
Figure 5-3: Configure Ref Source	5-5
Figure 5-4: Configure Full Scale Value.....	5-5
Figure 5-5: Output Measurement screen.....	5-5
Figure 5-6: Remote Current Programming Using Resistance.....	5-6
Figure 5-7: Remote Current Programming Using Voltage Source	5-7
Figure 5-8: Voltage Reference Mode	5-8
Figure 5-9: Remote Voltage Programming Using Resistance	5-9
Figure 5-10: Remote Voltage Programming Using 0-10 VDC Source	5-10

1 OVERVIEW

1.1 General Description

The Sorensen Asterion DC multioutput ASA Series of DC power supplies is a three-channel output supply in 1U Full rack size. Channel output voltage/ current ratings are selectable when ordering the power supply. Asterion DC multioutput ASA Series combines intelligence and flexibility to create an advanced platform of DC solutions.



Figure 1-1: Asterion DC Series Power Supply, 1U Models

The ASA Series power supply is a 3-output channel supply of 600W/Channel in 1U Full rack size. ASA Series is offered with Extended Wide Range Voltage and Current Models. The Extended Wide Range channels provides expanded current and voltage range at the full output power level, enabling the ability to satisfy a wider testing need without requiring the purchase of additional models.

The Asterion DC Multioutput ASA Series is Digital Signal Processor (DSP) controlled and can be operated from the intuitive, easy-to-use front panel touchscreen or the Ethernet LXI, USB, and RS232 standard control interfaces, as well as through the optional GPIB control interface.

The power supply can also be operated using Multioutput DC Virtual Panels. Virtual Panels allow remote control of the Asterion DC power supply as well as programming communication and monitoring of the instrument. You can perform all operations via

the remote Virtual Panels control as you could working directly with the unit's front panel.

This source also comes with the Optional Isolated Analog Programming Inputs and Monitor Outputs for output voltage and current. The independent analog inputs are available for each output channel, and they are isolated from channel power outputs.

This easy-to-configure design features sophisticated technology for delivering high performance, programmable DC power. Its sleek design packs maximum power density into a low-profile form factor; with an intuitive touch screen interface placing that power at your fingertips. Centralized control and unparalleled modularity make Asterion the most adaptable platform on the market. Its groundbreaking capabilities set the standard for affordable, precision power supplies.

The touchscreen function group icons include a Dashboard, Output Programming Parameters, Measurements, Ramp, Configuration, Control Interfaces, and System Settings. Function selection and parameter entry can be achieved either by direct selection from the touchscreen or by using the encoder selector button. The control resolution is adjusted by a dynamic rate change algorithm that combines the benefits of precise control over small parameter changes with quick sweeps through the entire range.

The Asterion DC Multioutput ASA Series is designed for testing today's complex electronics, including telecommunications and commercial electronics requiring low profile, light weight power supplies with high power density. Other applications include:

- ATE applications
- Military and aerospace electronics test
- DC power simulation
- Commercial manufacturing and process control
- Research and development
- Automotive component and battery testing

See *Figure 1-2* for decoding the Asterion DC Multioutput Series Model Number.

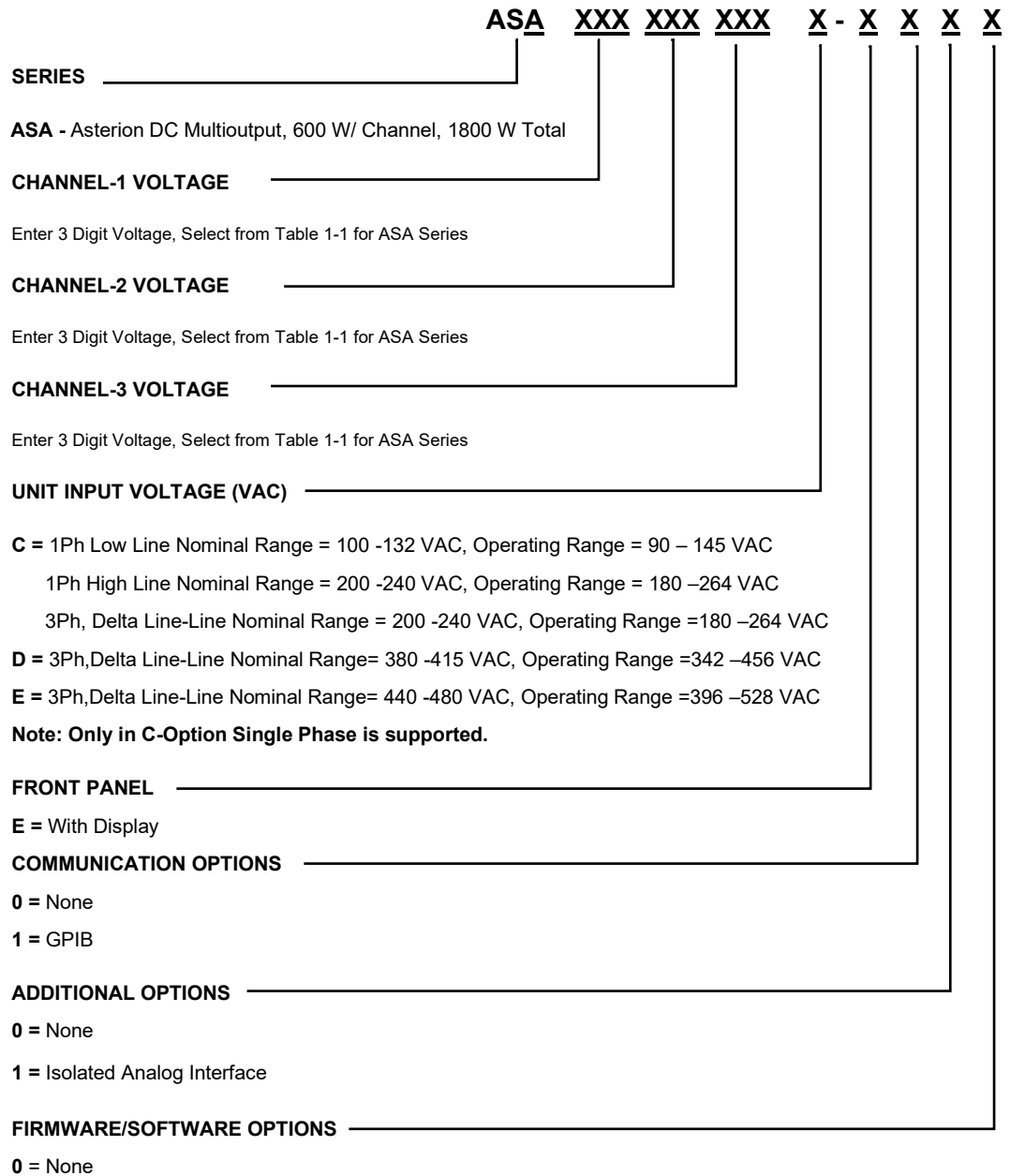

Figure 1-2: Asterion DC Multioutput ASA Series Model Number Decoding

3 Digit Voltage for ASA series
060
080
200
400
600
000 – Channel Not mounted only applicable for Channel 3

Table 1-1: Voltage Model for ASA series

1.2 Specifications

The following sections provide electrical, environmental, and physical specifications for the Asterion DC Multioutput Series power supplies.

Unless otherwise noted, the specifications are valid under the following conditions:

- a. Ambient temperature of $25 \pm 5^{\circ}\text{C}$, after a 30-minute warm-up, and at fixed AC input line and load.
- b. DC output into a resistive load.
- c. Specifications values are valid from 5% of the full-scale value.
- d. Stability is over an 8-hour period after a 30-minute warm up.
- e. If remote sense is used then the output voltage accuracy, regulation and stability specifications are valid at the point where the remote sense leads are connected.

1.2.1 Output Power

Model	Per channel Power	Total power (3 – Channels)
ASA Series	600 W	1800 W

Table 1-2: Output Power for ASA Series

1.2.2 ASA Series Output Voltage and Current Ratings

Voltage	Current
60 V	42 A
80 V	22 A
200 V	17 A
400 V	6 A
600 V	2.8 A

Table 1-3: Channel ratings for Asterion DC Multioutput ASA Model Series

Asterion DC Multioutput ASA Series, provides extended wide range output voltage and Current channels as provided in Table 1-3 and the power is rated at 600 W. The output current versus output voltage follows a constant-power curve to provide users a wider current and voltage operating range in a single power supply. The Extended Wide Range Voltage Vs Current Characteristics of the different ratings are shown in the Figure 1-3. The three channels would cover a wide range of voltage and current requirements for the customer.

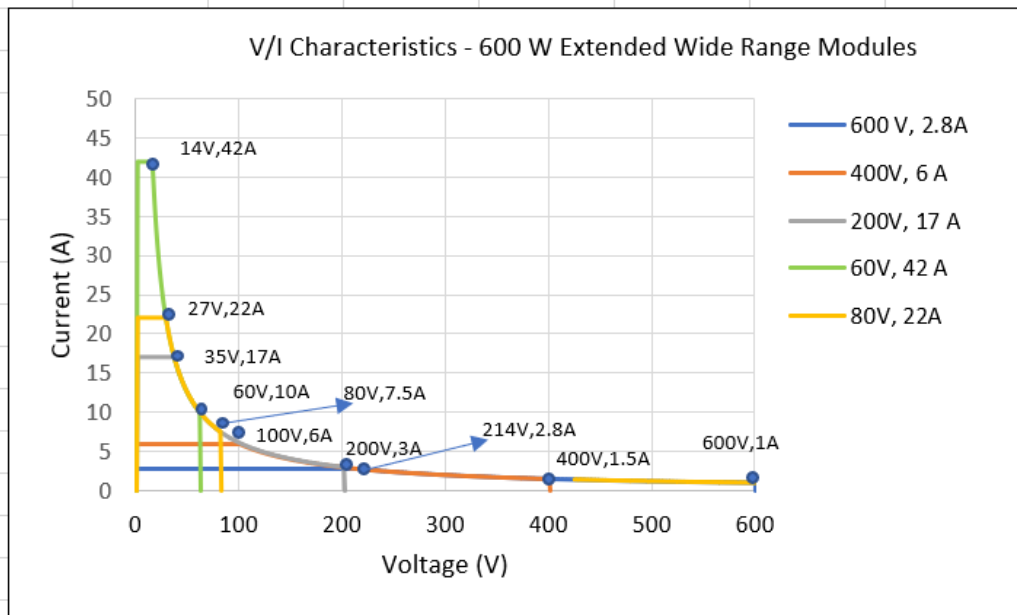

Figure 1-3 ASA Series Extended Wide Range Channels Voltage Vs Current Characteristics

The voltage and current characteristics of the 600 W, 200 V, 17 A is given in Figure 1-5. For any given voltage, the maximum supported current is described. There are three distinct regions, the red line shows the maximum supported current for a given model green line shows the maximum full-scale voltage for the model and the blue curved section shows the models power limit.

Determination of the available voltage or current under your conditions can be calculated readily. As an example, we will use the 600 W, 200 V, 17 A output channel. This channel can provide up to 17 A from 0 to 35.2 V and maximum of 3 A from 0 to 200 V. In the power limit portion of the curve if you need to determine how much current you can obtain at given voltage, you divide the models power limit by the desired output voltage. For example, at 100 V in this model you can obtain maximum current of 6 A ($600 \text{ W} / 100 \text{ V} = 6 \text{ A}$).

Figure 1-4 to Figure 1-8 provides with the Voltage – Current characteristics for 60 V-42A, 200 V-17 A, , 80 V- 22 A, 400 V – 6 A, 600 V – 2.8 A models respectively.

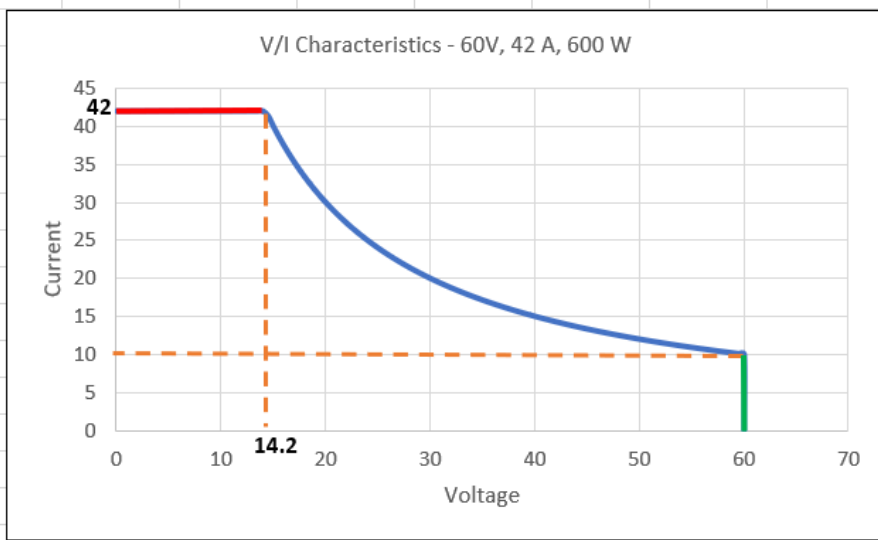

Figure 1-4 ASA Series 600W, 60 V, 42 A Voltage Vs Current Characteristics

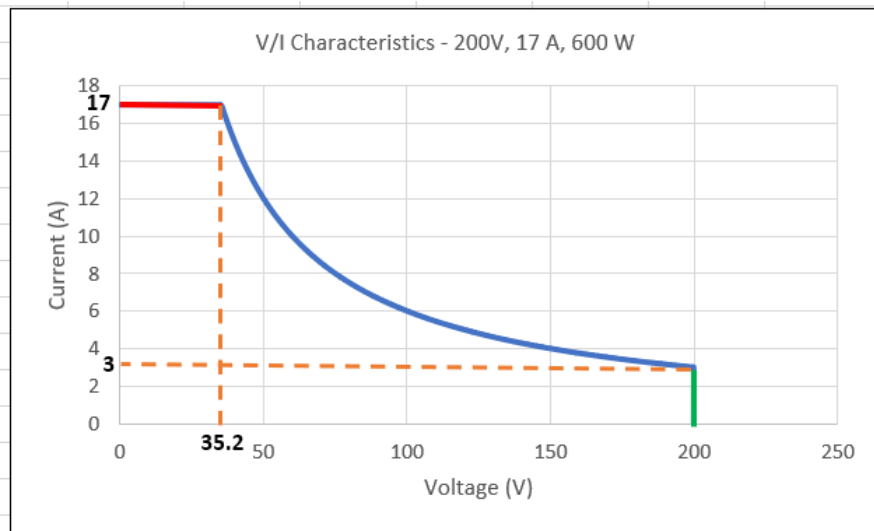

Figure 1-5 ASA Series 600 W, 200 V, 17 A Voltage Vs Current Characteristics

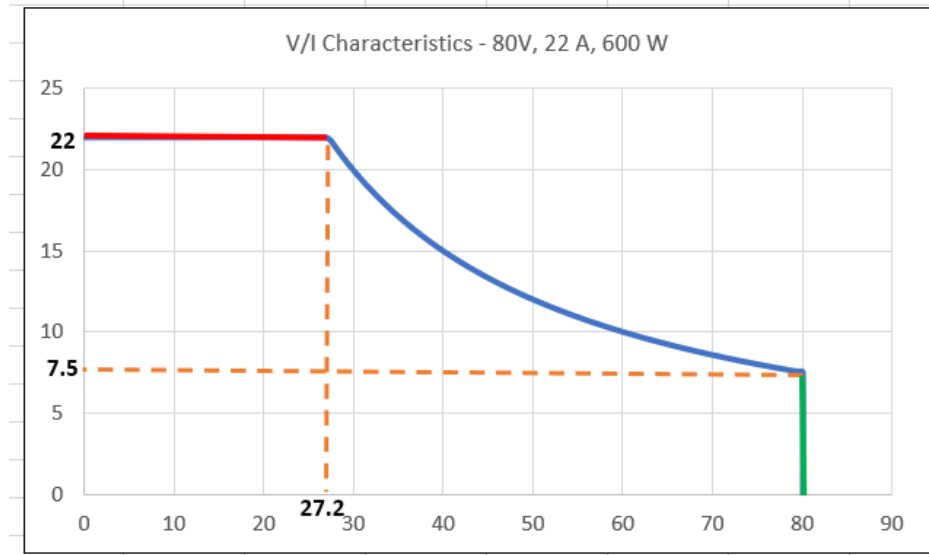

Figure 1-6 ASA Series 600 W, 80 V, 22 A Voltage Vs Current Characteristics

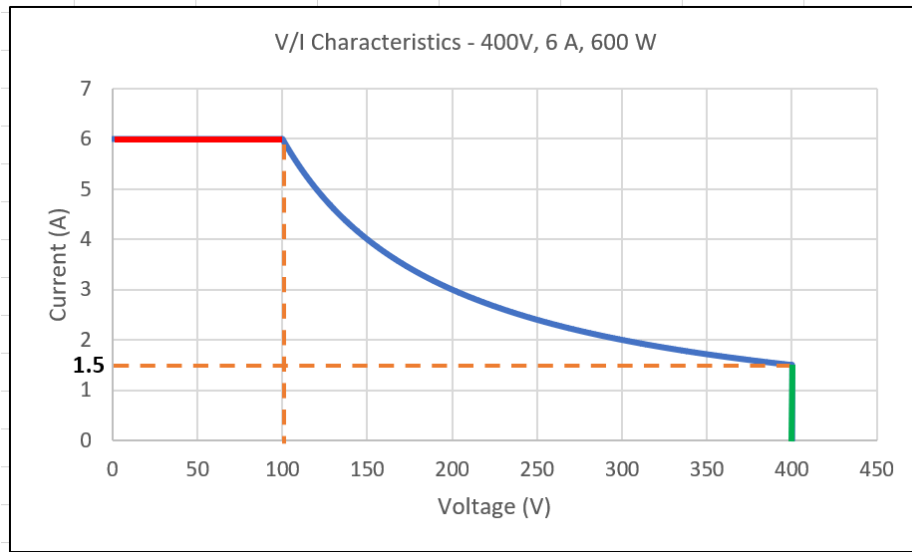

Figure 1-7 ASA Series 600 W, 400 V, 6 A Voltage Vs Current Characteristics

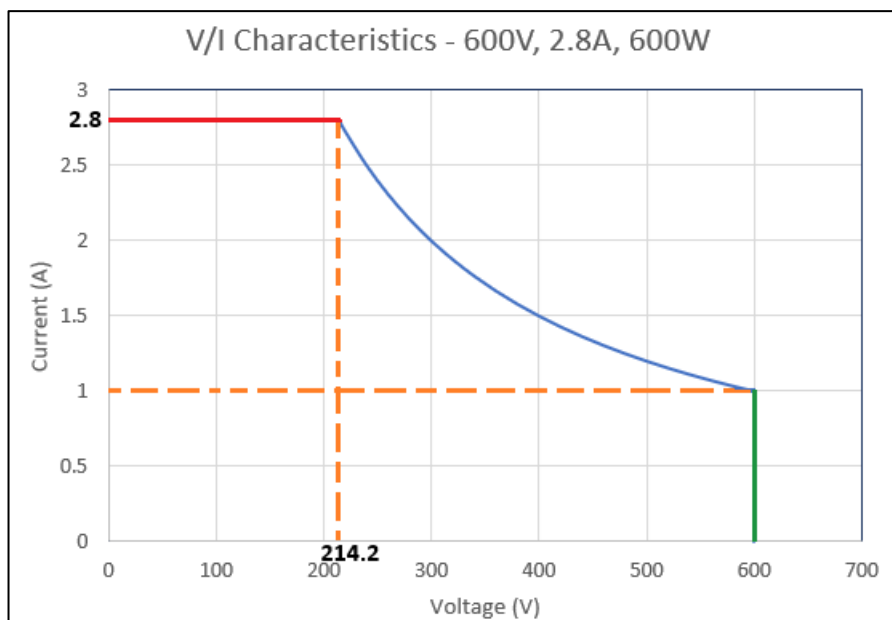

Figure 1-8 ASA Series 600 W, 400 V, 6 A Voltage Vs Current Characteristics

1.2.3 Resolution Specifications

Resolution	Remote digital Interface	Front panel
Voltage Output programming resolution	0.012% of full scale	4 Digits
Current Output programming resolution	0.012% of full scale	4 Digits
Power Output programming resolution	0.012% of full scale	4 Digits
Overvoltage programming resolution	0.1% of full scale	4 Digits
Voltage Output Readback resolution	0.012% of full scale	5 Digits
Current Output Readback resolution	0.012% of full scale	5 Digits
Power Output Readback resolution	0.012% of full scale	5 Digits

1.2.4 Remote Sense

Each channel is provided with sense terminals to sense voltage at the point of connection to the load. Line drop in the wires would be compensated by remote sense feature.

Output Voltage Models	Allowed Line drop Voltage
40 V	2 V
60 V	3 V
80 V – 600 V	5 V
Connection	Voltage accuracy specifications apply at the point where the remote sense leads are connected
Line Drop Effect on Output	There would be increased voltage equivalent to the line drop voltage at the

	terminals of the Power Supply.
	<p>CAUTION!</p> <p>Due to Line Drop Compensation, if Remote Sense is disconnected from unit while the output is enabled, output voltage will rise a maximum of 10% of model's maximum rated voltage, before faulting.</p>

1.2.5 DC Output Programming, Readback and Regulation Specifications ⁽¹⁾⁽²⁾

Programming & Measurement Accuracy (via Front Panel or Remote Digital Interface)	
Voltage Output programming accuracy	+/- 0.1% of rated output voltage
Current Output programming accuracy	+/- 0.2% of rated output current
Power Output programming accuracy	+/- 0.3% of rated output power
Overvoltage programming accuracy	+/- 1%, maximum, of rated output voltage
Voltage Output Readback accuracy	+/- 0.1% of rated output voltage
Current Output Readback accuracy	+/- 0.2% of rated output current
Power Output Readback accuracy	+/- 0.3% of rated output power
Overvoltage Response time	20 ms
DC Regulation Characteristics- Constant Voltage Mode	
Maximum line regulation	+/- 0.01% of rated voltage
Maximum load regulation	+/- 0.02% of rated voltage
Temperature Drift	+/- 100 PPM / degree Celsius
Stability	+/- 0.05% of rated voltage
DC Regulation Characteristics- Constant Current Mode	
Maximum line regulation	+/- 0.05% of rated current
Maximum load regulation	+/- 0.15% of rated current
Temperature Drift	+/- 100 PPM / degree Celsius
Stability	+/- 0.05% of rated current
DC Regulation Characteristics- Constant Power Mode	
Maximum line regulation	+/- 0.1% of rated power
Temperature Drift	+/- 100 PPM / degree Celsius
Stability	+/- 0.05% of rated power
<p>¹⁾ Output voltage accuracy, regulation and stability specifications are valid at the point where the remote sense leads are connected. In the unit remote sense mode to be selected using front panel or the digital interface.</p> <p>²⁾ Regulation is measured with all the three channels to the rated power</p>	

1.2.6 Output Ripple, Noise and Transient Specifications

Rated Output Voltage (V)	Voltage Ripple & Noise RMS, mV ⁽¹⁾	Voltage Ripple & Noise PK-PK, mV ⁽²⁾	Voltage & Current Rise Time (ms), Full load ⁽³⁾	Voltage & Current Fall Time (ms), Full load ⁽⁴⁾	Voltage Fall Time (ms), No load ⁽⁵⁾	Transient response (ms) ⁽⁶⁾
60	12	75	20	50	1500	1
80	15	90	25	60	2600	1
200	40	150	75	150	3500	2
400	80	300	100	200	4600	2
600	80	350	150	200	4800	2

¹⁾ RMS ripple/noise, over 20 Hz to 300 kHz bandwidth, is measured directly across the output terminals with the supply operating into 90% of rated resistive load in all channels and nominal AC input line voltage.

²⁾ PK-PK ripple/noise, over 20 Hz to 20 MHz bandwidth with the supply operating into 90% of rated resistive load in all channels and nominal AC input line voltage.

³⁾ Maximum time, from 0%-100% of programming change from zero to rated output voltage with rated resistive load.

⁴⁾ Maximum time, from 100%-0% of programming change from rated output voltage to zero with rated resistive load.

⁵⁾ Maximum time, from 100%-0% of programming change from rated output voltage to zero with No load

⁶⁾ Typical time to recover within 0.5% of rated output voltage for load step of 10-90% of rated output current. Transient response is measured with load change on one channel and two channels are loaded to 90% of the rated power.

1.2.7 AC Input Specifications

Model	600 W Per Channel Total 1800 W for 3 Channels in a Chassis
Input Voltage Configurations (Only factory configurable)	<p>Input Option "C": 3 phase, 3 wire + Gnd or 1 Phase, 2 wire + Gnd</p> <p>Nominal Rating Range for 3 phase 3 wire+ Gnd: 200- 240 VAC, 3 Phase, Line-Line.</p> <p>Nominal Rating Range for 1 phase, 2 wire+ Gnd Low Line range: 100 – 132 VAC⁽¹⁾, 1 Phase, Line- Neutral.</p> <p>Nominal Rating for 1 phase, 2 wire+ Gnd High Line range: 200 – 240 VAC⁽²⁾, 1 Phase, Line- Neutral.</p> <p>Input Option "D", 3 phase, 3 wire + Gnd</p> <p>Nominal Rating: 380 – 415 VAC, 3 Phase, Line- Line</p> <p>Input Option "E", 3 phase, 3 wire + Gnd</p> <p>Nominal Rating: 440- 480 VAC, 3 Phase, Line- Line</p>
Input Voltage, Operating range	<p>Input Option "C": 3 phase, 3 wire + Gnd, Operating Range 180 V-264 VAC Line-Line.</p> <p>Input Option "C": 1 phase, 2 wire + Gnd, Low line, Operating Range 90V-145 VAC Line-Neutral.</p>

	<p>Input Option “C”: 1 phase, 2 wire + Gnd, High line, Operating Range 180V-264 VAC Line-Neutral.</p> <p>Input Option “D”: 3 phase, 3 wire + Gnd, Operating Range 342-456 VAC Line-Line.</p> <p>Input Option “E”: 3 phase, 3 wire + Gnd, Operating Range 396-528 VAC Line-Line.</p>
Input Current, Maximum RMS	<p>Input Option “C”: 3 phase, 3 wire + Gnd: 7.6 A at 180 VAC Line-Line</p> <p>Input Option “C”: 1 phase, 2 wire + Gnd, Low line: 25 A at 90 VAC Line-Neutral.</p> <p>Input Option “C”: 1 phase, 2 wire + Gnd, High line: 12.8 A at 180 VAC Line-Neutral.</p> <p>Input Option “D”: 3 phase, 3 wire + Gnd: 4.7 A at 342 VAC Line-Line.</p> <p>Input Option “E”: 3 phase, 3 wire + Gnd: 4.1 A at 396 VAC Line-Line.</p>
Efficiency	<p>Input Option “C”: 3 phase, 3 wire + Gnd: 80%⁽³⁾</p> <p>Input Option “C”: 1 phase, 2 wire + Gnd, Low line: 80%⁽⁴⁾</p> <p>Input Option “C”: 1 phase, 2 wire + Gnd, High line: 80%⁽⁵⁾</p> <p>Input Option “D”: 3 phase, 3 wire + Gnd: 80%⁽⁶⁾</p> <p>Input Option “E”: 3 phase, 3 wire + Gnd: 80%⁽⁷⁾</p>
Inrush Current, typical⁽⁸⁾	<p>Input Option “C”: 3 phase, 3 wire + Gnd: 55 A Peak @ 264 V L-L</p> <p>Input Option “C”: 1 phase, 2 wire + Gnd, Low line: 30 A Peak @ 132 V L-N</p> <p>Input Option “C”: 1 phase, 2 wire + Gnd, High line: 55 A Peak @ 264 V L-N</p> <p>Input Option “D”: 3 phase, 3 wire + Gnd: 55 A Peak @ 456 VAC L-L</p> <p>Input Option “E”: 3 phase, 3 wire + Gnd: 55 A Peak @ 528 VAC L-L</p>
Input Frequency, Nominal Rating	50 Hz, 60 Hz
Input Frequency Range	47 Hz- 63 Hz
Power Factor⁽⁹⁾, typical	<p>a) 1-Ph: 0.98; active PFC</p> <p>b) 3-Ph: 0.95 for C option, active PFC</p> <p>c) 3-Ph: 0.80 for D and E options, active PFC</p>
Hold-Up Time⁽⁹⁾, typical	≥10 ms
Isolation Voltage	<p>1500 VAC Input to Ground,</p> <p>3000 VAC Input to Hazardous Secondary,</p> <p>3000 VAC Input to Isolated SELV barriers</p>

- 1) In Single Phase the Low Line Range 90 – 132 V AC, operating ambient temperature of operation to be limited to 40° C. Ensure the inlet wiring is capable of handling current up to 25 A to load up to 1800 W (600 W per Channel). If the unit is powered from the standard 15 A outlet, unit power to be derated to 1200 W (400W Per Channel).
- 2) In Single Phase High Line Range 180 – 264 V AC, operating ambient temperature to be limited to 40° C.
- 3) Typical value at full load 1800 W output (600 W per channel) and nominal AC input voltage of 208VAC L-L at 50/60 Hz input frequency.
- 4) Typical value at full load 1800 W output (600 W per channel) and nominal AC input voltage of 110VAC L-N at 50/60 Hz input frequency.
- 5) Typical value at full load 1800 W output (600 W per channel) and nominal AC input voltage of 220VAC L-N at 50/60 Hz input frequency.
- 6) Typical value at full load 1800 W output (600 W per channel) and nominal AC input voltage of 400VAC L-L at 50/60 Hz input frequency
- 7) Typical value at full load 1800 W output (600 W per channel) and nominal AC input voltage of 480VAC L-L at 50/60 Hz input frequency.
- 8) Not including EMI filter inrush less than 200us.
- 9) Measured at full load at rated nominal AC input voltage of 208 VAC/ 400 VAC/ 480 VAC L-L for 3 phase input and 110 VAC/ 220 VAC L-N for single phase input.
- 10) Contact to factory for high frequency operation for more details

1.2.8 Operational Characteristics

Parameter	Characteristic
Output Modes of Operation	Constant Voltage (CV), Constant Current (CC) and Constant Power (CP) modes are supported. User-selectable fold back mode CV/CC/CP or CV or CC or CP.
Front Panel Controls	Enhance front panel touch display for the unit enables control and programming of output channels. Organized menus to support Output Programming, Measurements, Power on Settings, Communication Controls & System Settings, External Analog interface, Voltage and Current ramp functions.
Voltage Ramp	Voltage Ramp could be generated with a programmable Dwell, Start and End Voltage set points. Dwell time could be set to 1 ms minimum and 9999 s maximum. Maximum slew to be limited to the transient specifications of the output model.
Current Ramp	Current Ramp could be generated with a programmable Dwell, Start and End Current set points. Dwell time could be set to 1 ms minimum and 9999s maximum. Maximum slew to be limited to the transient specifications of the output model.
Programmable ON/OFF delay between channels	Each output channel can be individually set to turn on or off in a sequence with a delay. The minimum programmable delay is 30 ms with an accuracy of +/- 2 ms.
Sequencing Function⁽¹⁾	Sequencing function is supported through multioutput DC Virtual panels software. Sequencing function allows the user to set up the supply to automatically run a series of voltage, current and power mode operations. This is especially useful for setting up the supply to test to compliance standards or unburdening the test computer in automated testing applications. Through RS-232, IEEE-488 or Ethernet, an external computer can trigger the sequences. Up to 50 sequences may be stored, with each sequence containing up to 20 individual steps. With the ability to string sequences together and an extensive list of step functions such as ramping, looping, go to and subroutine calls, the user can define a nearly infinite variety of test sequences.
Fault Identification	On-board diagnostics identify when power supply has experienced a fault.
DC Multioutput Virtual Panels	Virtual Panels allow remote control of the Asterion DC power supply as well as programming, communication, and monitoring of the instrument. You can perform all operations via the remote Virtual Panels control as you could working directly with the unit's front panel. Additionally, DC Virtual Panels provides sequencing functionality.
Programming Command Set	SCPI compliant command set and same could be used using all the communication interfaces (USB, RS232, Ethernet, IEEE-488).
GPIB interface, Option	Parallel interface complies with IEEE-488.1, IEEE-488.2, and the SCPI command specification
Analog Programming, Option	Provides Isolated Analog interface to program output.
Calibration	Calibration interval is 1 year; calibration is firmware-based through the SCPI commands using communication interface or Virtual Panels.
¹⁾ This feature is available through all the interfaces (USB, RS232, GPIB and Ethernet) and in the DC Multioutput Virtual panels whereas not available in the front panel.	

1.2.9 Front Panel Controls/Indicators

Model Type	Controls/Indicators
Enhanced Front panel	<p>Touch-Panel, TFT color LCD display with menu-based control; Display size: 1U models, 3.9" diagonal</p> <p>Rotary encoder for menu navigation and parameter adjustment and entry, with integrated selection switch.</p> <p>POWER switch: turns unit on/off.</p> <p>OUTPUT switch: turns output on/off of the selected channel. Output channel to be turned on/off could be selected through front panel dashboard.</p> <p>CH1 LED; indicates Channel-1 of the unit is in ON condition</p> <p>CH2 LED; indicates Channel-2 of the unit is in ON condition</p> <p>CH3 LED; indicates Channel-3 of the unit is in ON condition</p> <p>REM LED: Indicates that the unit is under control of the remote digital interface,</p> <p>FAULT LED: indicates that an internal fault has been detected and the output of all channels has been shut down.</p>

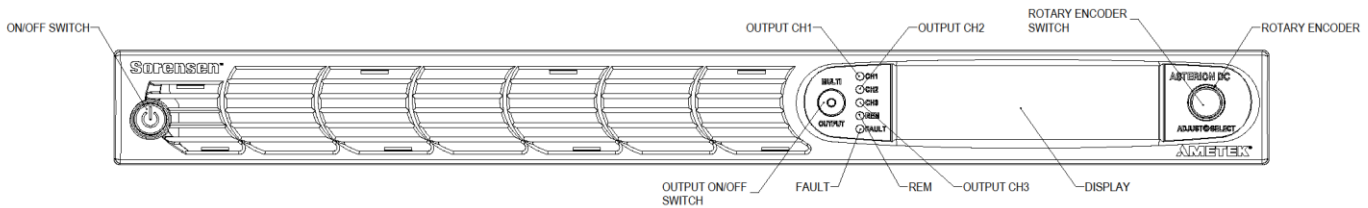

Figure 1-9: Front Panel Display, Controls, and indicators

1.2.10 Remote Isolated External User Control I/O Signal Interface Characteristics

Asterion DC Multioutput ASA Series provides 26-Pin Digital I/O interface connector for Trigger, Status output, Remote ON/OFF and Inhibit functions. Refer to operation manual for connector and pin details.

Function	Characteristics
Remote Output ON/OFF Control	Each channel is provided with control inputs to turn output ON/OFF the power supply. DC Input (+) 2.7V-24V will enable (turn-on) the output of the supply.
Remote Inhibit Input	<p>Switch/Relay contact closure or direct short from this terminal to signal return is required to Turn ON/OFF the power supply. Opening the contact would shut down the output.</p> <p>Remote inhibit can be configured in two modes (LATCH and LIVE)</p> <p>Latch - after reclosing the contact, user needs to clear the fault and turn ON the output.</p> <p>Live - after reclosing the contact, user needs to turn ON the output.</p>

	Remote circuit must sink up to 10 mA from 5 VDC to enable.
TRIGGER IN	TTL compatible Input signal, active-high; provides external hardware triggering of voltage, current Ramp, and sequencing functions. Signal connects to Open-anode of opto-isolator diode with internal 1kΩ series resistor internal to power supply. Voltage Rating: Maximum 24V, Minimum -5V Low state: 0.3 V max, High State 2.7V min
TRIGGER OUT	Output signal, active-high; synchronization pulse of 10 ms when a change in the output occurs. Open collector transistor output, Collector is connected the 26-pin connector. Emitter point of transistor is connected to common return pin of the interface connector. Voltage Rating: Maximum 30V, Minimum 3V for Active High Sink Current: 50mA
CC/CV status Output	Output signal, High state indicates Constant Current mode operation and Low state indicates Constant Voltage mode operation. Open collector transistor output, Collector is connected the 26-pin connector. Emitter point of transistor is connected to common return pin of the interface connector. Voltage Rating: Maximum 30V, Minimum 3V for Active High, Sink Current: 50mA
Output ON/OFF Status	Output signal, High state indicates Channel Output is ON and Low state indicates Channel Output is OFF Open collector transistor output, Collector is connected the 26-pin connector. Emitter point of transistor is connected to common return pin of the interface connector. Voltage Rating: Maximum 30V, Minimum 3V for Active High, Sink Current: 50mA
FAULT Status	Output Signal, High state indicates fault state of the power supply. Open collector transistor output, Collector is connected the 26-pin connector. Emitter point of transistor is connected to common return pin of the interface connector. Voltage Rating: Maximum 30V, Minimum 3V for Active High, Sink Current: 50mA

1.2.11 Remote Control Digital Interface Characteristics

Interface	Characteristic
LAN	Ethernet LXI Compliant 10BASE-T and 100BASE-T over twisted-pair cables compliant with IEEE 802.3; Connector: 8P8C modular jack.
USB	Serial interface compliant to USB 2.0; Connector: Type-B receptacle.

RS-232C	Serial interface compliant to RS-232C; Protocol: data bits, 7 with parity and 8 without parity; stop bits, 2; baud rate, 9600 to 115200; handshake, CTS and RTS; Connector: Subminiature-D, 9-contact receptacle.
IEEE-488 (Option)	Parallel interface complies with IEEE-488.1, IEEE-488.2, and the SCPI command specification; command execution response time, 10 ms, typical; connector: IEEE-488.1 compliant.
Firmware Upgrade	Firmware can be upgraded through the LAN interface.

1.2.12 Optional Remote Isolated Analog Programming Interface Characteristics

Each channel of the Asterion DC Multioutput ASA Series is provided with 8-Pin connector for the analog programming functions. Refer to operation manual for the connector and pin details.

Function	Characteristics
Remote Analog Programming of Output Voltage and Output Current	Independent Signal inputs for output voltage and current programming using External Analog Reference. Analog reference source is user selectable and can be a voltage or resistance. Selected analog reference source type is common to both voltage and current programming. Voltage as Reference Source: Full Scale Voltage could be set by the user from 5V to 10V. Resistance as Reference Source: Full Scale Voltage could be set by the user from 5kΩ to 10kΩ. Programming accuracy and linearity: ±1% of rated output Programming accuracy and linearity: ±1% of rated output
Monitor Signals for the Output Voltage and Output Current	Monitor Signals for the Output Voltage and Current. Full Scale range: 0V to 10V corresponds to 0-100% full-scale output Minimum recommended Load: 100kΩ, typical Maximum Load: 20 kΩ Monitor accuracy and linearity: ±1% of full-scale output

1.2.13 Protection Function Characteristics

Function	Characteristics
Output Overvoltage Protection (OVP)	Programmable to 110% of full-scale output voltage for each channel; exceeding OVP threshold results in shutdown of output.
Output Current Limit Protection	User-selectable fold back mode CV/CC/CP or CV or CC or CP. In CV/CC/CP mode, output current or power is regulated to setpoint on reaching limit.

	In CV mode, on reaching current or power limits results in shutdown of output; In CC mode, on reaching voltage or power limits results in shutdown of output; In CP mode, on reaching voltage or current limits results in shutdown of output; In CV or CC or CP mode, shutdown delay on reaching the limit is programmable from 100 ms to 5 s.
AC Input Overcurrent Protection	Internal fuses in each phase for fault isolation; not user replaceable
AC Input Undervoltage Protection	Automatic shutdown for insufficient AC input voltage
AC Input Transient Protection	Protection to withstand EN61326-1, Class-A surge levels
Overtemperature Protection (OTP)	Internal temperature monitors cause shutdown of output if temperature thresholds are exceeded

1.2.14 Output Isolation

Parameter	Specification
Output terminal Positive (+Ve) and Negative (-Ve)	±600 V _{RMS} , maximum, with respect to chassis ground.
Isolated Analog interface Signals and External User Control I/O interface to Output Negative terminal	±600 V _{RMS} , maximum; optional Isolated Analog programming and external user interface signals are isolated from negative output terminal; operation of Isolated Analog Interface signals should be at SELV safety voltage conditions to chassis ground.

1.2.15 Environmental Specifications

Parameter	Specification
Operating Temperature	0°C to 50°C (32° F to 122° F)
Storage Temperature	-40°C to 85°C (-40°F to 185° F)
Altitude	3000 m (10,000 ft), output current derating 2%/100 m or ambient 1°C/100 m above 2000 m
Operating Humidity	20-90 %, non-condensing
Relative Humidity	10-95 %, non-condensing
Vibration	MIL-PRF-28800F, Class 3; 5-500 Hz per Paragraph 4.5.5.3.1.
Shock	MIL-PRF-28800F, Class 3; 30G half-sine with 11ms duration per Paragraph 4.5.5.4.1.
Transportation Integrity	ISTA Test Procedure 1A

1.2.16 Mechanical Specifications

Parameter	Specification
Dimensions	H, 1.75" (44.45 mm); W (front panel), 19.0" (483 mm); D, 24.0" (609.6 mm); H, 1.75" (44.45 mm); W (chassis), 16.9" (429 mm); D, 23.0" (584 mm).

Unit Weight	28lbs, maximum
Shipping Weight	34lbs, maximum
Chassis Material	Steel with plastic front panel
Chassis Finish	Galvanized Zinc, G90
Installation	Protective covers are provided for AC input and DC output; Rackmount as per ANSI-EIA-310-D, with front panel mounting flange brackets and chassis provisions for mounting rack slides; slides and flange brackets/handles options available.
Cooling	Force-air cooling; linear, variable fan speed control; air intake at front/sides and exhaust at rear.
Acoustic Noise	68 dBA, maximum; measured at 1 m with A-weighting;

1.2.17 Regulatory Agency Compliance

Parameter	Specification
EMC	CE marked for EMC Directive 2014/30/EU per EN 61326-1:2013 Class-A for Emissions and Immunity levels as required.
Safety	NRTL certified for US and Canada to CAN/CSA-C22.2 No. 61010-1-12, UL 61010-1 Third Edition. CE marked for LVD Directive 2014/35/EU to EN 61010-1 Third Edition as required.
CE Mark LVD Categories	Installation Overvoltage Category II, Pollution Degree 2, Indoor Use Only.
RoHS	CE marked for RoHS Directive 2011/65/EU per EN IEC 63000:2018 as required.

1.2.18 Rear Panel Connectors

Connector	Description
AC Input	1-Phase AC input: connector terminals L1/L2 or L2/L3; 3-Phase AC input: connector terminals L1, L2, and L3; Unit side connector: compression terminals, Phoenix P/N 1708514; Mating Connector, Phoenix P/N 1709173
Safety-Ground	M4 x 0.7 chassis stud
DC Output and Remote Sense	DC Output and remote sense terminal; Unit side connector: compression terminals, Phoenix P/N 1720835 Mating Connector, Phoenix P/N 1777875
Isolated External User Control I/O interface	User Control signal interface Connector; Unit side connector: high-density, 26-contact, female D-Type, Norcomp P/N 181-026-213R531 Mating connector, Norcomp P/N 180-026-103L001
Isolated Analog interface (Optional)	Isolated analog interface connector, Total 3 Nos, Individual connector for each channel; Unit side connector: Miniature mate and lock type, TE Connectivity P/N 2-1445055-8 Mating Connector, TE Connectivity P/N 1445022-8
LAN Interface	Ethernet 10BASE-T and 100BASE-T; safety isolation SELV-rated, referenced to chassis;

	connector: 8P8C modular jack.
RS-232 Interface	Serial interface to RS-232C; safety isolation SELV-rated, referenced to chassis; connector: Subminiature-D, 9-contact receptacle.
USB Interface	Serial interface to USB 2.0; safety isolation SELV-rated, referenced to chassis; connector: Type-B.
IEEE-488 Interface (Optional)	Parallel interface to IEEE-488.1, IEEE-488.2, and SCPI; safety isolation SELV-rated, referenced to chassis; connector: IEEE-488.1 compliant.

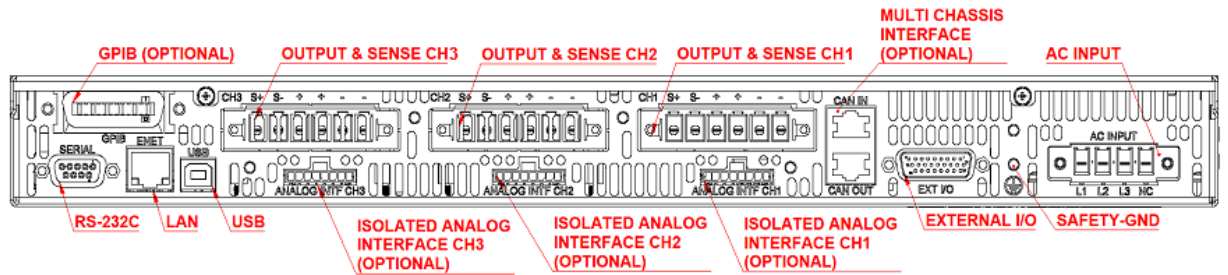

Figure 1-10: Rear Panel Connectors with GPIB Option

1.2.19 Overall Dimensions Drawing

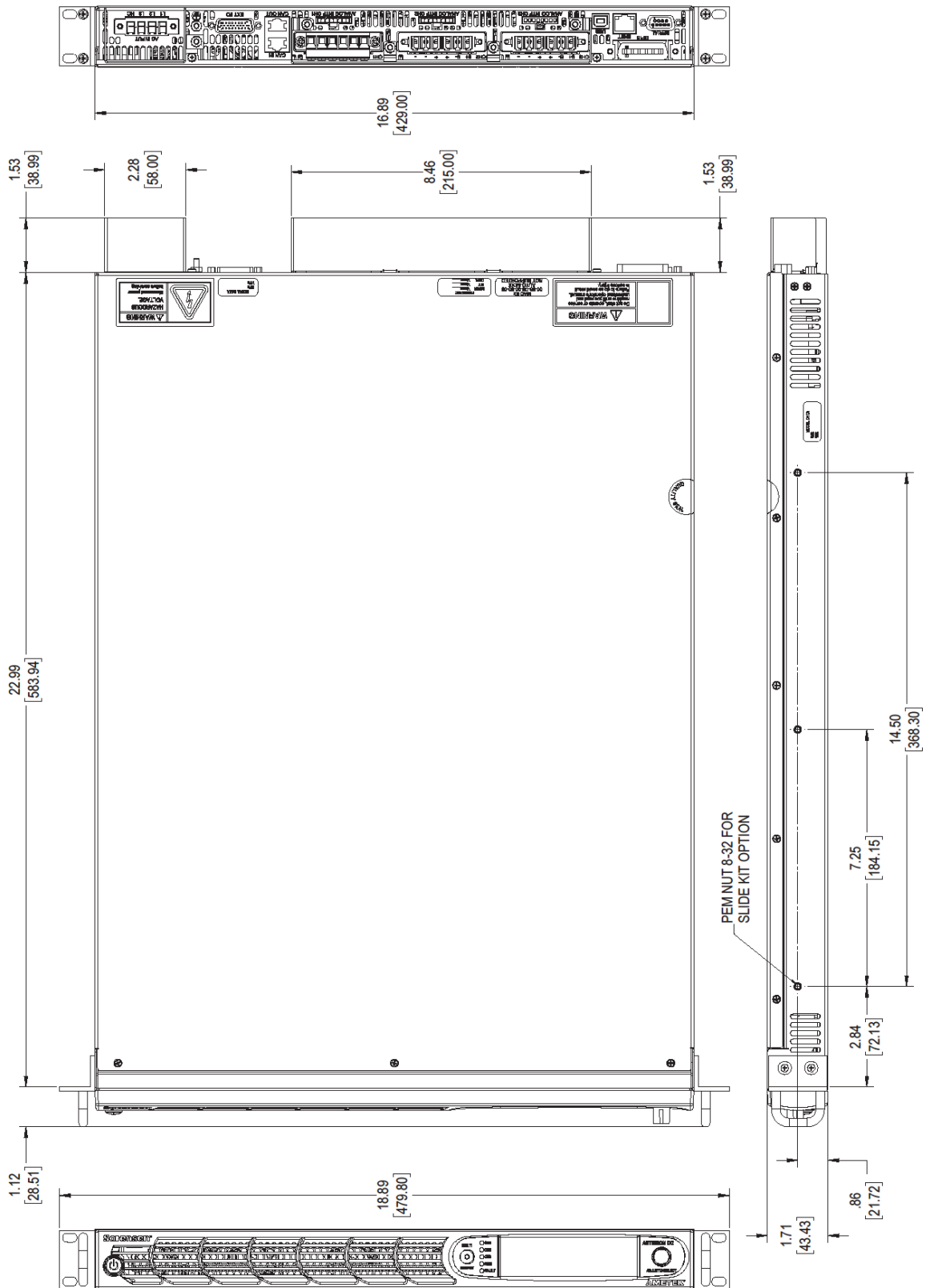

Figure 1-11 Dimensional Drawing

2 INSTALLATION

2.1 Inspection

Inspect the shipping carton for possible damage before unpacking the unit. Carefully unpack the equipment. Save all packing materials until inspection is complete. Verify that all items listed on the packing lists have been received. Visually inspect all exterior surfaces for dented or damaged exterior surfaces, and broken connectors, display, or controls. External damage might be an indication of internal damage.

If any damage is evident, immediately contact the carrier that delivered the unit and submit a damage report. Failure to do so could invalidate future claims. Direct repair issues to AMETEK Customer Service Department at 858-458-0223 (local) or 1-800-733-5427 (toll free in North America).

2.2 Contents of Shipment

Depending on the model, configuration, and options selected for your Asterion Multioutput Series power source, the ship kit may include additional parts and accessories.

Minimum items included in the ship kit:

1. DC Output Power and Remote Sense Mating Connector, Refer to Item 1 in Table 2-1.
2. AMETEK CD-ROM (P/N M550008-01) containing the Asterion DC Multioutput Series User Manual (P/N M330516-01), and the Asterion DC Multioutput Series Programming Manual (P/N M330517-01). Refer to Item 2 in Table 2-1.
3. Input power mating connector, Refer to Item 3 in Table 2-1.
4. Bracket and Handles kit (P/N 5330241-01R), Refer to Item 4 in Table 2-1.
5. Protective cover for DC output, Refer to Item 5 in Table 2-1.
6. Protective cover for AC input, Refer to Item 6 in Table 2-1.
7. KEPS Steel Nut for installing AC Input and DC output protective covers, Refer to Item 7 in Table 2-1.
8. Analog programming Mating connector, Refer to Item 8 in Table 2-1.

9. Crimp pins for Analog programming Mating Connector, Refer to Item 9 in Table 2-1.
10. EMC kit (P/N-5331080-01R) contains ferrite core, Refer to Item 10 in Table 2-1.

Item No	Part number	Description	Qty	Manufacturer	Manufacturer Part number
1	893-006-06	TERM BLK,6P,41A,1KV, PLG,7.62MM	3 ⁽¹⁾	Phoenix	1777875
2	M550008-01	MANUAL, SORENSEN, CD ROM	1	Ametek	M550008-01
3	893-004-41	TERM BLK,4P,41A,1KV, PLG,7.62MM	1	Phoenix	1709173
4	5330241-01R	KIT,RKMT BRACKET & HANDLES-DYN	1	Ametek	5330241-01R
5	9330722-01R	COVER, SFTY O/P, MLT O/P, DC -AST	1	Ametek	9330722-01R
6	9330655-01R	COVER, DC INPUT, 1U	1	Ametek	9330722-01R
7	MN-M04K-07	NUT M4X0.7 KEPS STEEL ZN PLATE	6	Any	M4 -0.7 KEPS Zinc Plated Steel
8	856-144-22	CONN, 8P, HOUSING,1R, 3MM, CRIMP	3 ⁽²⁾	TE Connectivity	1445022-8
9	856-794-10	CONTACT, SKT, 20-24AWG, CRIMP, TIN	24 ⁽³⁾	TE Connectivity	794610-1
10	995-350-33	CORE,HINGED,335 OHM,100MHZ,1IN	1 ⁽⁴⁾	Fair-Rite Products Corp	0444177081
⁽¹⁾ Qty would be 2 Nos for the two-channel power supply; Terminal block is assembled with a label indicating the pin details.					
⁽²⁾ Qty would be 2 Nos for the two-channel power supply, Item No 7 is supplied when only Isolated Analog Programming option is Ordered					
⁽³⁾ Qty would be 16 Nos for the two-channel power supply, Item No 7 is supplied when only Isolated Analog Programming option is Ordered					
⁽⁴⁾ Two turns of the AC Input cable excluding the earth cable need to be passed through the Ferrite core, before connecting to the unit (One turn means the cable must be passed once through the Ferrite core).					

Table 2-1: Ship Kit Details

Note: If any of these parts are missing, contact AMETEK Customer Service Department at 858-458-0223 (local) or 1-800-733-5427 (toll free).

Optional accessories:

1. 5330201-01R: Rackmount slide kit; includes two slides with rack adapter brackets and mounting hardware.

2.3 Mechanical Installation

The Asterion DC Multioutput Series power source is designed for rackmount applications, there is an option for a rack mounted slide. Rack mounting requires installing the flange brackets with handles to the side of the chassis: using M4-0.7 x 6 mm Philips flat-head screws to mount the brackets to the chassis, and # 8-32 Philips flat-head screws to mount the handles to the brackets.

The unit is forced air cooled with internal fans drawing air in from the front and sides and exhausting at the rear. The front and rear of the unit must be kept clear of obstruction and clearance must be maintained to allow unimpeded airflow. The same consideration given to the side grilles will minimize internal temperature rise. Special consideration must be made to overall air flow characteristics, and the resultant

internal heat rise, when a source is installed inside enclosed cabinets to avoid excessive heating and over-temperature problems. The temperature of the ambient air at the air intake should not exceed 50°C.

	WARNING!
	This unit is intended for installation in a protected environment. Exposure to conductive contaminants or corrosive compounds/gases that could be ingested into the chassis could result in internal damage. Install the power source in a temperature and humidity controlled indoor area.
	CAUTION!
	The power source should be provided with proper ventilation. The front and rear of the unit must be free of obstructions. To ensure proper airflow, a minimum 2" clearance from the rear air outlet is required.
	CAUTION!
	No user serviceable parts are inside; service is only to be performed by qualified personnel.

2.4 Brackets and Handles

The bracket and handles kit consist of the following items:

5330241-01R 1U

Part Number	Description	MFG	Item #	Qty
9330233-01R	BRKT, 1U, CHAS MTG EAR -DYN	CD ALEXANDER	1	2
MH-8125-BA	HANDLE,RND,1.25IN,AL,BLK,ANODZ	HANDLES UNLIMITED	2	2
110EG20-08	SCREW,8-32 X .500,PFH,100D,SS	ANY	3	4
FM1001	SCREW,M4,18-8,FLAT HD,SS,.7X6	ANY	4	4

Recommended kit installation instructions are as follows:

1. Install the brackets, item **#1**, to the front side panels with M4 screws, item **#4**, (two on each side).
2. Tightening torque is 11 in-lb.
3. Install the handles, item **#2**, to the brackets, item **#1**, with 8-32 screws, item **#3** (two one each side).
4. Tightening torque is 11 in-lb.

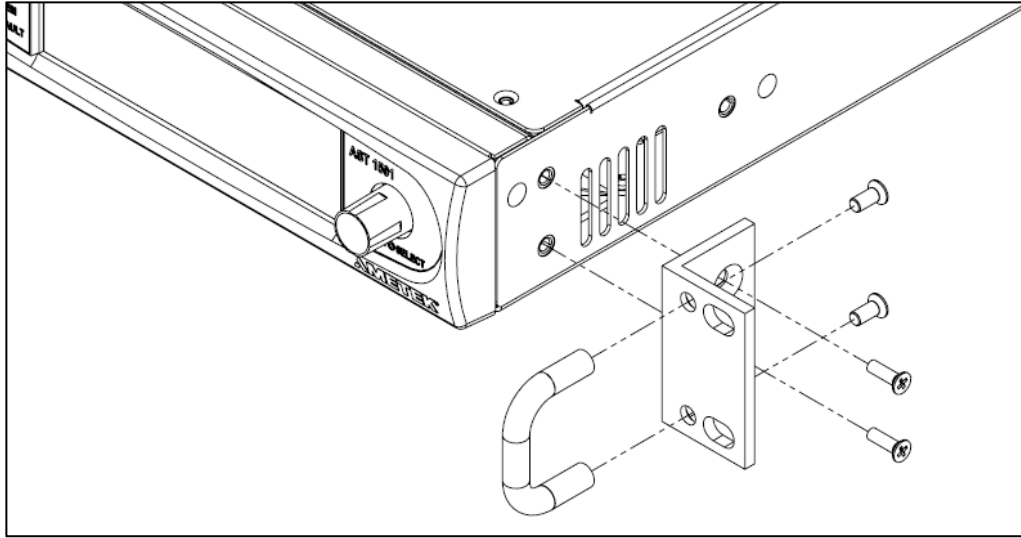

Figure 2-1: Brackets and Handles mounting, 1U Models

2.5 Rack Mounting

The Asterion DC Multioutput Series power source is designed for mounting in a standard 19-inch equipment rack that is compliant to ANSI/EIA-310-D. If other instrumentation is mounted in the rack adjacent to the unit, there is no need for additional clearance above or below the source. It should be supported in the rack using appropriate L-brackets or rackmount slides. Refer to Figure 2-2 for typical rackmount installation. The rack mounting slide kit, part number **5330201-01R** consists of the following items:

Part Number	Description	MFG	Item #	Qty
105-510-24	RACK SLIDES, FRICTION, 24 IN, SS	JONATHAN 510QD-24	1	2
9330325-01R	BRKT, RACKSLIDE -DYN	AMETEK	2	4
110-800-06	SCREW, 8-32 X .375, PFH100, LK, SS	ANY	4	14
112EN04-01	NUT, 8-32, W/CONE WASHER, KEP, CS	ANY	5	8
110GS04-08	SCREW, 10-32 X .500, SEMS, PPH, CS	ANY	6	12
112GI04-01	NUT, 10-32, ZINC PL	ANY	7	12

Note: Item #1 consists of three parts (item #1A, item #1B and item #1C) as shown in Figure 2-2.

Install the rackmount kit as follows:

1. Install the slide sections item #1 (supplied as part of item #1) on both sides of the power supply chassis with screws, item #4 (three on each side).

2. Install the brackets, item #2, , to the cabinet sections of the slides, item #1C (supplied as part of item #1) , with screws, item #4, and nuts, item #5 (four on each side).
3. Adjust the location of the mounting brackets as required for the rack cabinet vertical rails utilized.
4. Mount the cabinet sections of the slides, item #1C, (with brackets already installed) into the cabinet using appropriate hardware (e.g., the screws and nuts supplied, item #6 and item#7, or user-supplied bar-nuts, cage-nuts, clip-nuts), while ensuring that they are level, front to back and left to right, on the cabinet rails.
5. Insert adjustable side sections, item #1B (supplied as part of item #1), into cabinet slide sections, item #1C. Insert power supply chassis with installed slide sections, item #1A, into the adjustable slide sections, item #1B.

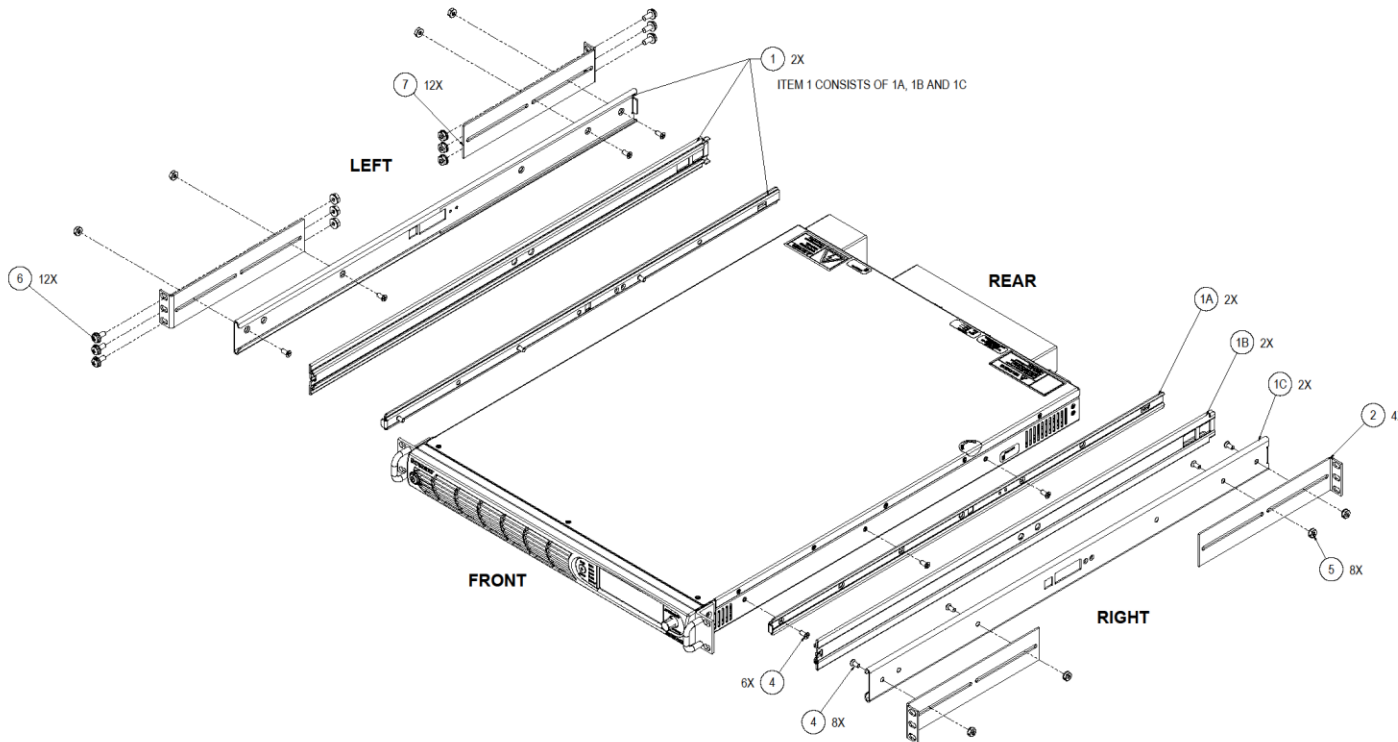

Figure 2-2 Rack mounting, 1U Multi output Asterion DC Series Model

2.6 Chassis Removal from Rack

The slides have a front disconnect feature and lock at full extension. To disconnect and remove the chassis from the rack, depress the flat steel spring (located on the slides) inward, and pull the chassis forward. To return the chassis back into the rack from full extension, depress the flat steel spring (located on the slides) inward, and push the chassis back.

When the chassis is at full extension, the flat springs are located behind the front rack rails. Retract the springs with a flat blade screwdriver or similar device to release from lock-out or to remove the chassis from the rack.

2.7 Outline drawings

Figure 2-3 shows the outlines and overall dimensions for installation of the Asterion DC multi output ASA Series power source without relay option.

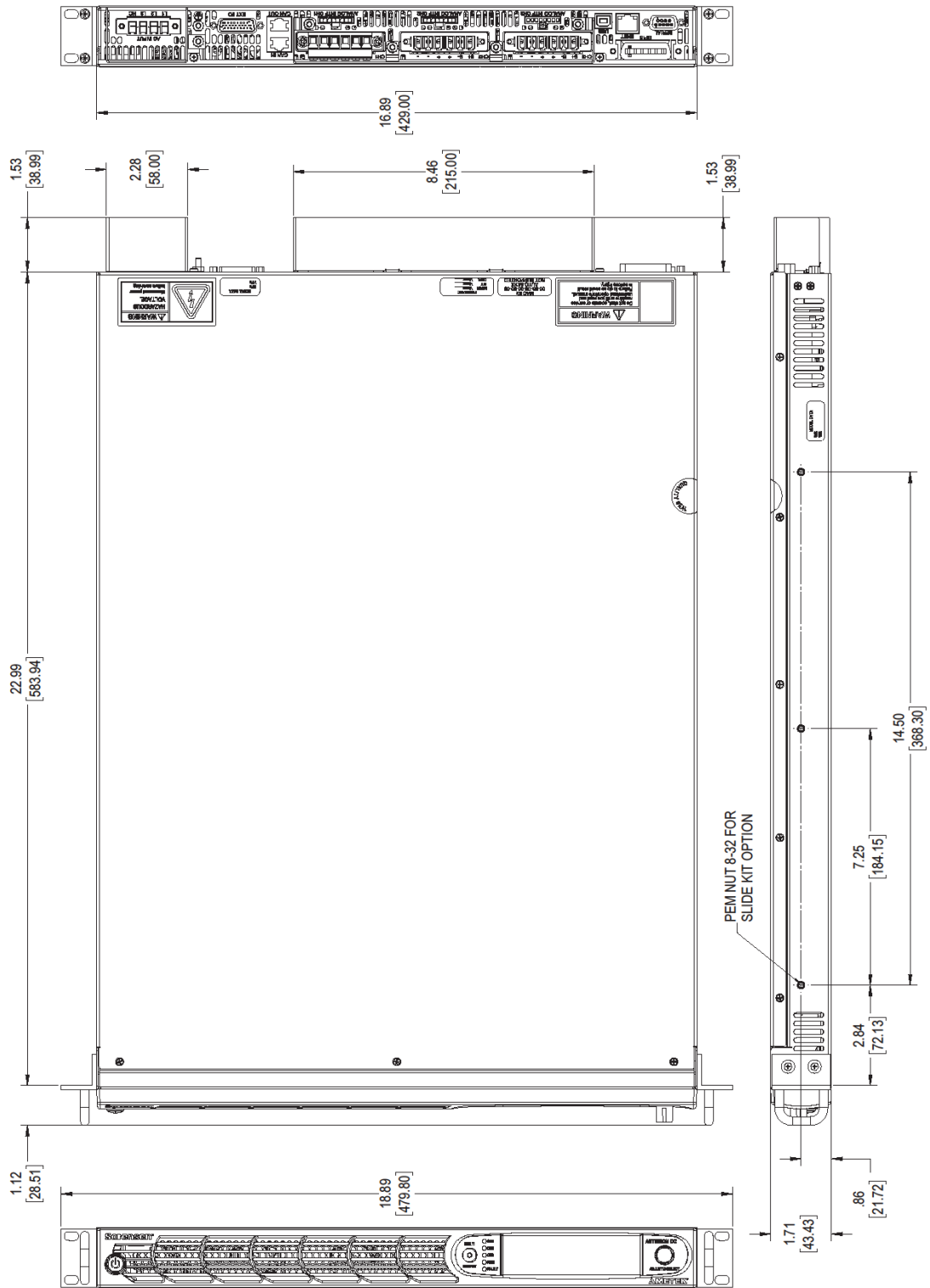



Figure 2-3: Installation Drawing

Figure 2-4 shows the rear panel view of the power sources and the location of the connectors with GPIB option.

Figure 2-5 shows the installation of the rear panel protective covers for the AC input and DC Output terminations. The components comprising these covers are supplied in the ship kit.



CAUTION!

M4 0.7 KEPS nuts - Maximum tightening torque is 1.1Nm (10 lb-in.).

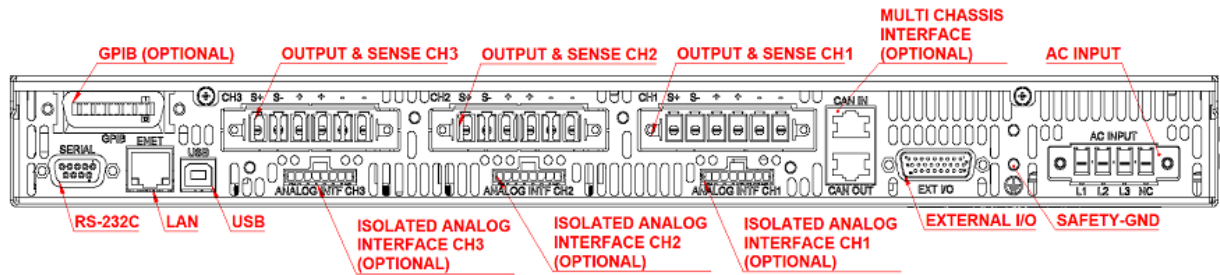

Figure 2-4: Rear Panel View with GPIB option

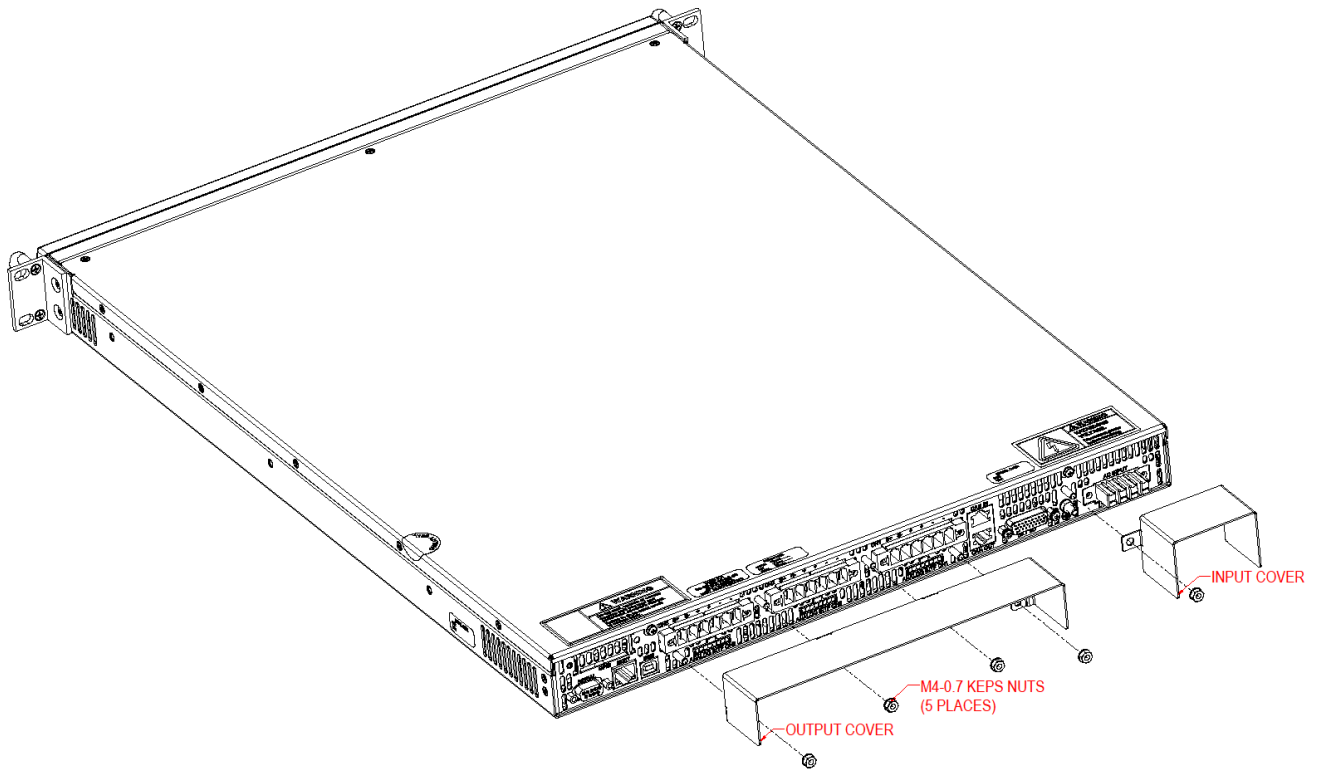







Figure 2-5: Rear Panel Protective covers installation

2.8 Rear Panel Input/ Output Connections

Figure 2-4 shows the rear panel view of the power source and locations of the rear panel connector for the rear panel view of the 1U model power source showing the location of the connectors. Table 2-2 provides details of the connectors located in the rear panel of the power source.

	<p>WARNING!</p> <p>High voltage present at rear panel poses risk of electrical shock. The input and output covers maintain protection against hazardous voltages. Do not remove protective covers on AC input or DC output. Refer installation and servicing to qualified personnel.</p>
	<p>WARNING!</p> <p>The input and output voltages at the rear panel of the unit might be HAZARDOUS LIVE. When rack-mounting or panel-mounting the unit, suitable safeguards must be taken by the installer to ensure that HAZARDOUS LIVE voltages are not OPERATOR accessible. OPERATOR access should only be to the front panel of the unit.</p>
	<p>WARNING!</p> <p>A safety disconnect device for the AC mains input must be installed so that it is readily accessible to the user.</p>
	<p>WARNING!</p> <p>A properly sized input overcurrent protection device must be installed at the AC mains input, either a circuit breaker or fuse having a rating of 25% over the maximum AC input line currents listed in Table .</p>
	<p>WARNING!</p> <p>To prevent an electrical shock hazard, a safety ground wire must be connected from the safety ground stud on the rear panel to the AC mains ground.</p>
	<p>CAUTION!</p> <p>Under no condition should the negative output terminal exceed 600V to earth ground. Floating the negative output terminal subjects the internal control circuitry of the power supply to the same potential as present at the negative output terminal. The signals of analog programming and external user interface connector are isolated from the output terminals of the power supply.</p>

Connector	Function	Connection
L1 – AC, L2 – AC, L3 – AC, Chassis - GND	AC input power; see section 2.9	AC mains 3-phase input/ 1-phase input
DC Output and Remote Sense Connector	DC output power and Remote voltage sensing; see section 2.10	Output load
External User Control connector	User Control interface;	User controller

RS-232C connector	RS-232C connector for remote digital control; see section 2.13.3.	External digital interface
USB Connector	USB type B connector for remote digital control; see section 2.13.4.	External digital interface
Ethernet connector	Ethernet connector for remote digital control; see section 2.13.5.	External digital interface
Isolated Analog Interface connector (Option)	User Analog Control interface; see section 2.13.1	User controller
GPIO (IEEE-488) (Option)	GPIO (IEEE-488) Option connector for remote digital control.	External digital interface

Table 2-2: Rear Panel Connector

No of Channels	Voltage Model	AC Input Option Code	Nominal Input Voltage, Range VAC	Maximum Input Line Current, A (RMS)
3	60V- 400 V	C - 3 Phase Input	200V - 240V	6.9
		C- 1 Phase Low Line Input	100V - 132V	23
		C- 1 Phase High Line Input	200V - 240V	11.5
		D	380V - 415V	4.3
		E	440V - 480V	4
2	60V- 400 V	C - 3 Phase Input	200V - 240V	4.6
		C- 1 Phase Low Line Input	100V - 132V	15.3
		C- 1 Phase High Line Input	200V - 240V	7.7
		D	380V - 415V	2.9
		E	440V - 480V	2.7

Table 2-3: Maximum Input Line Current

2.9 AC input power connection

The Multioutput Asterion DC Series power source is designed to operate from 1-phase or 3-phase input power, having 2 wire/3-wire plus ground, with nominal AC input voltage (Refer Table 2-3), and 50/60 Hz input frequency. The AC input voltage range is automatically selected by the unit at power-up; no user setup is required. Power factor correction (PFC) provides high power factor, minimizing the required input apparent power and current harmonic distortion. Refer to the specifications of Section 1.2 for AC input current requirements, and derating of output power as a function of AC input voltage.

2.9.1 AC input overcurrent protection

The Asterion DC Multioutput Series power source has fuses at the AC input for fault protection. These fuses are internal to the chassis and are not user accessible. They provide fault isolation in case a failure occurs of internal components or wiring. A suitable overcurrent protection device must be provided externally, within the system installation, to protect the external wiring and interconnects.

2.9.2 AC Input Safety Disconnect Device

The Multioutput Asterion DC Series power source front panel POWER switch does not disconnect the AC input line from the unit. Ensure that an appropriately rated safety disconnect device is incorporated in the installation that will provide isolation from the AC input when the device is opened. The device could be a switch or circuit breaker, and must be located close to the unit, within reach of the operator, and clearly labeled as the disconnection device.

2.9.3 AC Input Connector

The AC input connector, AC INPUT, is located on the rear panel, along with the safety-ground stud. Figure 2-6 shows the rear panel view of the connector and stud. Table 2-4 shows the functions and connector pinout, and Table 2-5 lists the connector type.

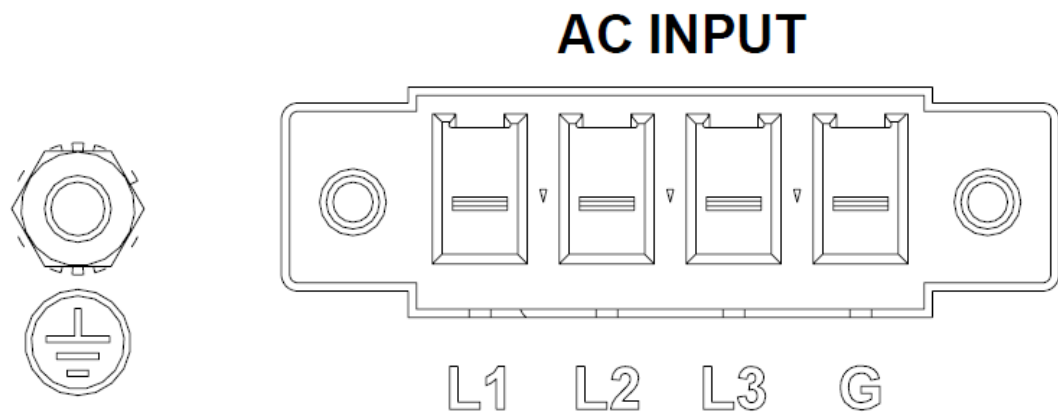

Figure 2-6: AC Input Connector and Safety-Ground Stud

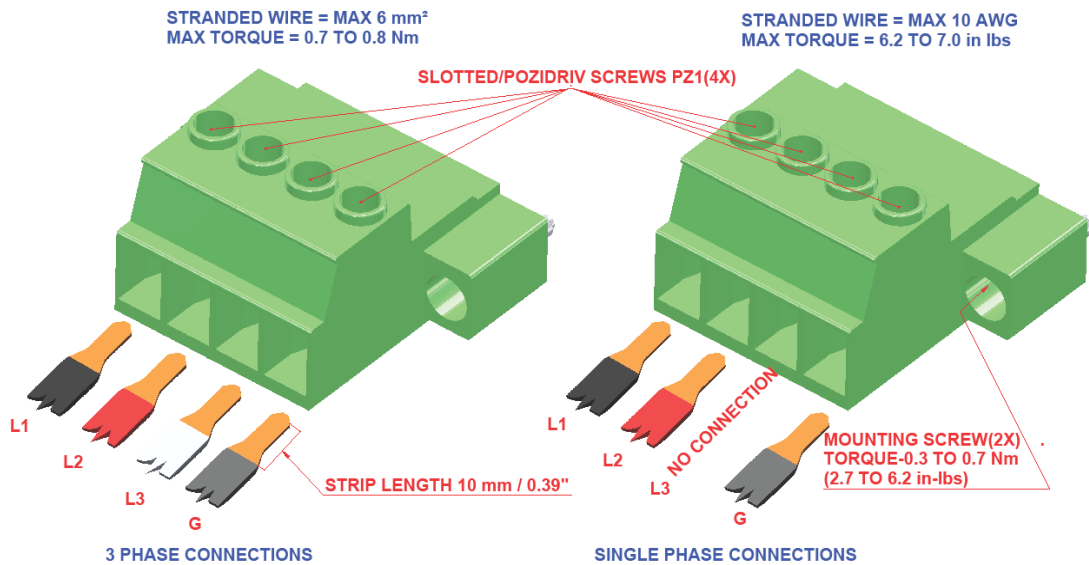

Figure 2-7: AC Input Connector wiring

A 1-Phase input is connected to terminals L1/L2 or L2/L3 (do not connect a 1-Phase input between L1/L3), while a 3-Phase input is connected to L1/L2/L3 (a connection to neutral is not utilized with 3-Phase input). The connector has compression terminals with female contacts. A ground connection must always be made to the utility earth protection ground using the AC Input connector pin or rear panel safety-ground stud. Figure 2-7 shows the AC input connector wiring for 3-phase and 1-Phase connections.

Name	Type	Function
AC INPUT L1	AC Input	Line-1 input from utility AC mains; For 1-Phase input, connect lines to terminals L1 and L2, or L2 and L3; or L1 and L3
AC INPUT L2	AC Input	Line-2 input from utility AC mains. For 1-Phase input, connect lines to terminals L1 and L2, or L2 and L3; or L1 and L3
AC INPUT L3	AC Input	Line-3 input from utility AC mains; For 1-Phase input, connect lines to terminals L1 and L2, or L2 and L3; or L1 and L3
GND	Safety Ground	Safety-Ground connection from utility earth protection-ground.

Table 2-4: AC Input Connector Pinout and Safety-Ground

Connector	Type
AC Input	Chassis connector header: Phoenix P/N 1708514; 4-position, compression terminals; Mating connector: Phoenix P/N 1709173; compression terminals; housing retained to header with screws; Wire stripping length: 10 mm (0.39"); Tightening torque: 0.7 Nm, min (6.1 lb-in) to 0.8 Nm, max (7 lb-in); Wire cross section: 0.2 mm ² , min (24 AWG) to 6 mm ² , max (10 AWG). Refer to Phoenix P/N 1709173 manufacturer datasheet for the complete specifications of the Mating Connector.
Safety-Ground	Use the GND pin (G) provided in the input AC connector, or the Stud provided in the rear panel for Safety-Ground Connection. For using the rear panel M4-0.7 x 7 stud, use nut tightening torque is 1.1 Nm (10 lb-in) max.

Table 2-5: AC Input Connector Type



CAUTION!

To prevent damage to the AC input mating connector, follow torque specifications, and, if a wire ferrule is used, ensure that it is properly sized and that it has been crimped with the appropriate ferrule crimping tool.

2.9.4 1-Phase AC Input Operation- Only Supported in Input AC voltage type “C”

Connect the utility AC mains wires to the rear panel AC input connector terminals, L1/L2, L2/L3, or L1/L3. Ensure that the voltage does not exceed 264 VAC. The power source does not require a neutral connection, so the input could be between any two lines that have a voltage that does not exceed 264 VAC. Use wires with ratings equal to or greater than the current rating listed in the Table 2-8. A ground wire must be connected from the rear panel safety-ground terminal or the rear panel safety ground stud to the utility power earth protection-ground.

**CAUTION!**

For Input AC voltage type “C” units, do not connect an AC voltage that is greater than 264 VAC, either line-to-neutral or line-to-line, for 1-Phase or 3-Phase inputs. Exceeding the maximum AC input voltage could result in damage to the unit.

**CAUTION!**

A ground wire must be connected from the rear panel safety-ground terminal or the rear panel safety ground stud to the utility power distribution earth protection-ground.

2.9.5 3-Phase AC Input Operation



Connect the utility AC source wires to the rear panel AC input connector terminals, L1/L2/L3; a neutral connection is not required. Ensure that the line-line voltage does not exceed 264 VAC if power supply with C option and do not exceed 456 VAC if power supply with D option and do not exceed 528 VAC if power supply with E option. Use wires with ratings equal to or greater than the current rating listed in the specifications Table 2-8. A ground wire must be connected from the rear panel safety-ground terminal or the rear panel safety ground stud to the utility power distribution earth protection-ground.

**CAUTION!**

Input AC voltage type “C”: Do not connect an AC voltage that is greater than 264 VAC, either line-to-neutral or line-to-line, for 1-Phase or 3-Phase inputs. Exceeding the maximum AC input voltage could result in damage to the unit.

**CAUTION!**

Input AC voltage type “D”: Do not connect an AC voltage that is greater than 456 VAC, line-to-line for 3-Phase input. Exceeding the maximum AC input voltage could result in damage to the unit. Single phase input is not supported with voltage type “D”

	<p>CAUTION!</p> <p>Input AC voltage type “E”: Do not connect an AC voltage that is greater than 528 VAC, line-to-line for 3-Phase input. Exceeding the maximum AC input voltage could result in damage to the unit. Single phase input is not supported with voltage type “E”</p>
	<p>CAUTION!</p> <p>A ground wire must be connected from the rear panel safety-ground terminal or the rear panel safety ground stud to the utility power distribution earth protection-ground.</p>

2.10 DC Output and Remote Sense power connections

The DC output and remote sense connector for each channel is located on the rear panel. Figure 2-8 shows the rear panel view of the connector. Table 2-6 shows the functions and connector pinout, and Table 2-7 lists the connector type. Figure 2-9 shows the DC output and remote sense connection wiring details.

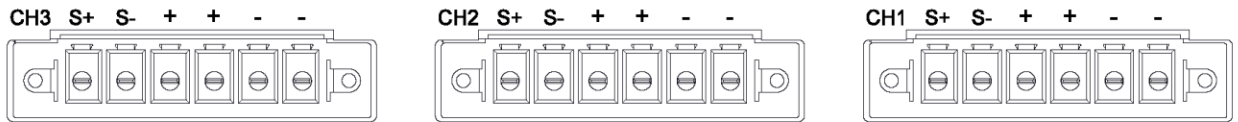



Figure 2-8: Output and Remote Sense Connector of each channel

Name	Type	Function
S+	Remote Sense Positive DC Input	Positive DC input from the point where voltage needs to be regulated
S-	Remote Sense Negative DC Input	Negative DC input from the point where voltage needs to be regulated
+	Positive DC Power Output	Positive DC Power Output for connection to the Load
+	Positive DC Power Output	Positive DC Power Output for connection to the Load
-	Negative DC Power Output	Negative DC Power Output for connection to the Load
-	Negative DC Power Output	Negative DC Power Output for connection to the Load

Table 2-6: DC Output and Remote Sense Connector Pinout

Connector	Type
DC Output and Remote Sense	Chassis connector header: Phoenix P/N 1720835; 6-position, compression terminals; Mating connector: Phoenix P/N 1777875; compression terminals; housing retained to header with screws; Wire stripping length: 10 mm (0.39"); Tightening torque: 0.7 Nm, min (6.1 lb-in) to 0.8 Nm, max (7 lb-in); Wire cross section: 0.2 mm ² , min (24 AWG) to 6 mm ² , max (10 AWG). Refer to Phoenix P/N 1777875 manufacturer datasheet for the complete specifications of the Mating Connector.

Table 2-7: DC Output and Remote Sense Connector Type



CAUTION!

The output DC connector provides two terminals each for positive and negative DC outputs rated at 25A. Loads requiring more than 25A to use two wires from individual output pins provided in the connector and connections to be made externally to the load. Looping of the wires in the output connector would cause over heating of the output terminals and would cause damage to the power supply.



CAUTION!

To prevent damage to the DC Output and Remote sense mating connector, follow torque specifications, and, if a wire ferrule is used, ensure that it is properly sized and that it has been crimped with the appropriate ferrule crimping tool.

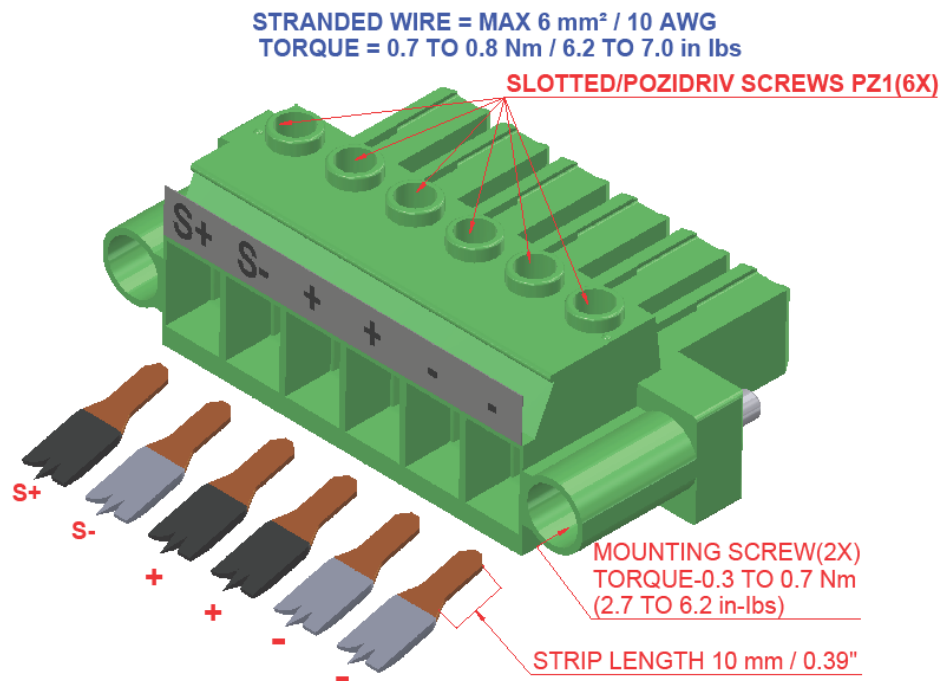

Figure 2-9: DC Output and Remotes Sense Connector wiring

Output voltage sensing is user-selectable to be either local sense or remote sense. Sensing provides the signal for measurement of the output voltage and determines the physical point where the output voltage is precisely regulated. Local and Remote sense both are at the rear panel output connector, while remote sense is at the load, through a cable connection from the rear panel remote sense Pin S+ and S-. Based on the user selection (local or remote) corresponding sense signal is used by the controller as the voltage feedback. Figure 2-8, shows the remote sense connector at the rear panel of the power supply.

Remote sensing is used to compensate for the voltage drop that occurs across the wires connecting the load to the output of the power source. A separate pair of wires is routed to measure the voltage at the terminals of the load where precise regulation of the output voltage is desired. The remote sense leads are connected at the remote sense connector on the rear panel; refer Figure 2-8. Connect the terminal, Sense Positive (S+), to the point at the load that is connected to the Output Positive terminal, and the terminal, Sense Negative (S-), to the point at the load that is connected to Output Negative terminal.

On selecting the remote sense, if the difference between the remote sense and the local sense exceeds more than 5% of the rated output voltage, then the unit would go to fault state. The fault can arise due any of the following conditions.

1. If the remote sense is selected and the remote sense wiring is not done to the power supply unit.
2. If the remote sense is connected in the reverse polarity.
3. If the load cable drop exceeds 5% of the rated output voltage.

On the remote sense fault condition, the output voltage would get programmed to zero.

2.11 Wire Gauge Selection

Care must be taken to properly size all conductors for the input and output of the power source. This section provides guidance in the selection of wire size.



CAUTION!

Use wire with Class B or C stranding. Fine-stranded (flexible) wire should not be used unless crimp-on lugs or ferrules are utilized that are approved for fine-stranded cables.

2.11.1 Wire Size

The tables below will assist in determining the appropriate wire size for both the input and output connections. Table 2-8 gives minimum recommended wire size; these recommendations are for 30°C ambient, and for copper wire only. This table is derived from the National Electrical Code and is for reference only. Local laws and conditions may have different requirements. For higher ratings, wires can be paralleled; refer to the National Electrical Code for guidelines.

Size	Temperature Rating of Copper Conductor		
	60°C	75°C	90°C
AWG	Types: TW, UF	Types: RHW, THHW, THW, THWN, XHHW, USE, ZW	Types: TBS, SA, SIS, FEP, FEPB, MI, RHH, THHN, THHW, XHH, XHHW
	Current Rating, A(RMS)		
18	–	–	14
16	–	–	18
14	15	20	25
12	20	25	30
10	30	35	40
8	40	50	55
6	55	65	75
4	70	85	95
3	85	100	115
2	95	115	130
1	110	130	145
0	125	150	170
00	145	175	195
000	165	200	225
0000	195	230	260

Table 2-8: Minimum Wire Size

When determining the optimum cable specification for your power applications, the same engineering rules apply whether at the input or output of an electrical device. Therefore, this guide applies equally to the input cable and output cable for this power source and application loads.

Power cables must be able to safely carry maximum load current without overheating or causing insulation degradation. It is important to power source performance to minimize IR (voltage drop) loss within the cable. These losses have a direct effect on the quality of power delivered to and from the power source and corresponding loads.

When specifying wire gauge, consider derating due to operating temperature at the wire location. Wire gauge current capability and insulation performance drops with the increased temperature developed within a cable bundle and with increased environmental temperature. Therefore, short cables with derating of gauge size and insulation properties are recommended for power source applications.

Be careful when using published commercial utility wiring codes. These codes are designed for the internal wiring of homes and buildings and accommodate the safety factors of wiring loss, heat, breakdown insulation, aging, etc. However, these codes consider that up to 5% voltage drop is acceptable. Such a loss directly detracts from the performance specifications of this power source. Also, consider how the wiring codes apply to bundles of wire within a cable arrangement.

In high performance applications requiring high inrush/ transient currents, additional consideration is required. The cable wire gauge must accommodate peak currents developed at peak voltages, which might be up to five times the RMS current values. An underrated wire gauge adds losses, which alter the inrush characteristics of the application and thus the expected performance.

Table 2-9 presents wire resistance and resulting cable voltage drop at maximum rated current, with the wire at 20°C. Copper wire has a temperature coefficient of $\alpha = 0.00393\Omega/^\circ\text{C}$ at $t_1 = 20^\circ\text{C}$, so that at an elevated temperature, t_2 , the resistance would be $R_2 = R_1 (1 + \alpha (t_2 - t_1))$.

The output power cables must be large enough to prevent the line voltage drop (total of both output wires) between the power source and the load from exceeding the remote sense capability as presented in the specification section. Calculate the voltage drop using the following formula:

$$\text{Voltage Drop} = 2 \times \text{distance-in-feet} \times \text{cable-resistance-per-foot} \times \text{current}$$

Size, AWG	A(RMS), (90°C wire)	Ohms/100 Ft, (One Way)	Voltage Drop/100 Ft, (Column 2 x Column 3)
18	14	0.639	8.95
16	18	0.402	7.24
14	25	0.253	6.33
12	30	0.159	4.77
10	40	0.100	4.00
8	55	0.063	3.47
6	75	0.040	3.00
4	95	0.025	2.38
3	115	0.020	2.30
2	130	0.016	2.08
1	145	0.012	1.74
0	170	0.0098	1.67
00	195	0.0078	1.52
000	225	0.0062	1.40
0000	260	0.0049	1.27

Table 2-9: Wire Resistance and Voltage Drop, 20°C

2.12 Load Considerations

This section provides guidelines for incorporating protective diode networks at the output of the power supply to prevent damage while driving inductive loads or loads having stored energy that could be circulated back to the power supply.

2.12.1 Inductive and Stored-Energy Loads

To prevent damage to the power supply from inductive voltage kickback, connect an antiparallel diode (rated at greater than the supply’s output voltage and current) across

the output: Connect the cathode to the positive output and the anode to return. Where positive load transients, such as back EMF from a motor might occur, or stored energy is present such as a battery, a second blocking diode in series with the output is recommended to protect the power supply. Refer to Figure 2-10.

2.12.1.1 BLOCKING AND ANTI-PARALLEL DIODES

Ensure that the chosen components are suitably rated for the inductance and energy to be dissipated. The Peak Reverse Voltage ratings should be a minimum of 2 times the Power Supply maximum output voltage. The Continuous Forward Current ratings should be a minimum of 1.5 times the power supply maximum output current. A heatsink may be required to dissipate the power caused by flow of current.

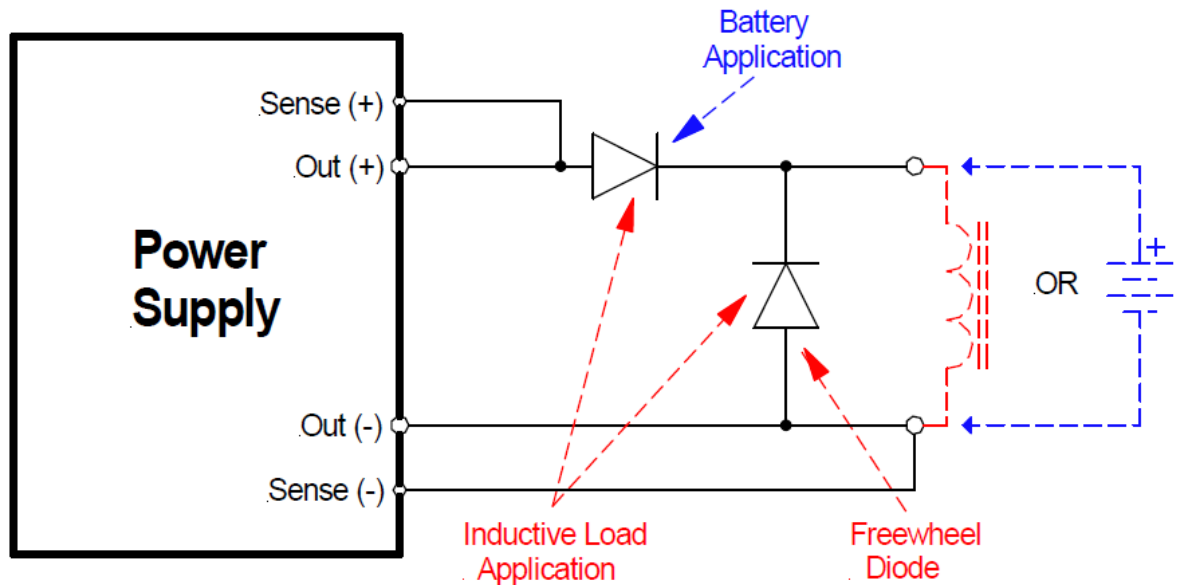

Figure 2-10: Diode Connections

2.13 Rear Panel User Interface Connectors

The rear panel contains the connectors for the remote analog programming interface, external user control I/O interface, digital communications interfaces (LAN, USB, RS-232C, and optional GPIB IEEE-488).

2.13.1 Remote Analog programming

The remote analog programming connector is located on the rear panel for each channel. Figure 2-11 shows the rear panel view of the connector for the three channels and Table 2-10 lists the connector type. Table 2-11 shows the functions and Table 2-12 shows the connector pinout.



Figure 2-11: Analog Programming connector

Connector	Type
Remote Analog programming	Miniature mate and lock type, TE Connectivity P/N 2-1445055-8 Mating Connector, TE Connectivity P/N 1445022-8 Crimp Pin, TE Connectivity P/N 794610-1

Table 2-10: Analog Programming Connector Type

Function	Characteristics
Remote Analog Programming of Output Voltage and Output Current	Independent Signal inputs for output voltage and current programming using External Analog Reference. Analog reference source is user selectable and can be a voltage or resistance. Selected analog reference source type is common to both voltage and current programming. Voltage as Reference Source: Full scale Voltage could be set by the user from 5V to 10V. Resistance as Reference Source: Full Scale Voltage could be set by the user from 5kΩ to 10kΩ. Programming accuracy and linearity: ±1% of rated output
Monitor Signals for the Output Voltage and Output Current	Monitor Signals for the Output Voltage and Current. Full Scale range: 0V to 10V corresponds to 0-100% full-scale output Minimum recommended Load: 100kΩ, typical Maximum Load: 20kΩ Monitor accuracy and linearity: ±1% of full-scale output
Isolation voltage Analog interface Signals to Output Negative terminal	±600 V _{RMS} , maximum; Analog programming interface signals are isolated from negative output terminal; operation of Isolated Analog Interface signals should be at SELV safety voltage conditions to chassis ground.

Table 2-11: Analog Programming Connector characteristics



Pin	Signals	Type	Description
1	VPRG-VSOUR	ANALOG INPUT	Remote control input for voltage programming using a voltage source connected between this pin 1 and 3 signal return. Signal return: Pin 3

			<p>Range: Full scale Voltage could be set by the user from 5V to 10V.</p> <p>Input impedance: 20kΩ, typical</p>
2	VPRG-ISOUR	ANALOG INPUT	<p>Remote control input for voltage programming using a resistance connected between this pin and signal return. Current Source of 1 mA is internally connected to this pin to enable resistance programming.</p> <p>Signal return: Pin 3</p> <p>Range: Full Scale Voltage could be set by the user from 5kΩ to 10kΩ.</p> <p>Note: Do not exceed resistance of maximum 10kΩ.</p>
3	PRG-RTN	PROGRAMMING RETURN	<p>Return for Pin 1 and 2.</p> <p>Pin 3 – PRG-RTN is shorted with Pin 6 – MON-RTN internal to the power supply.</p>
4	IPRG-VSOUR	ANALOG INPUT	<p>Remote control input for current programming using a voltage source connected between this pin and signal return.</p> <p>Signal return: Pin 3</p> <p>Range: Full scale Current could be set by the user from 5V to 10V.</p> <p>Input impedance: 20kΩ, typical</p>
5	IPRG-ISOUR	ANALOG INPUT	<p>Remote control input for current programming using a resistance connected between this pin and signal return. Current Source of 1 mA is connected to this pin from the power supply to enable resistance programming.</p> <p>Signal return: Pin 3</p> <p>Range: Full Scale Current could be set by the user from 5kΩ to 10kΩ.</p> <p>Note: Do not exceed resistance of maximum 10kΩ</p>
6	MON-RTN	MONITOR RETURN	<p>Return for Pin 7 and 8.</p> <p>Pin 3 – PRG-RTN is shorted with Pin 6 – MON-RTN internal to the power supply.</p>
7	VMON	ANALOG OUTPUT	<p>Monitor signal for output voltage</p> <p>Signal return: Pin 6</p> <p>Range: 0V to 10V corresponds to 0-100% full-scale output. Output impedance: 100Ω, typical</p> <p>Minimum recommended Load: 100kΩ, typical Maximum Load: 20kΩ</p>
8	IMON	ANALOG OUTPUT	<p>Monitor signal for output current</p> <p>Signal return: Pin 6</p> <p>Range: 0V to 10V corresponds to 0-100% full-scale output. Output impedance: 100Ω, typical</p>

			Minimum recommended Load: 100kΩ, typical Maximum Load: 20kΩ
--	--	--	--

Table 2-12: Analog Programming Connector Pin out

The pinout function mentioned in Table 2-12 is identical for each channel connectors. To program desired channel corresponding analog channel connector to be utilized.

	CAUTION! Return signal of all the three channels are shorted internal to the power supply. Applying a voltage potential between the channel return signal of the individual channels would damage the power supply.
	CAUTION! Analog programming interface signals are isolated from negative output terminal; Isolation voltage is rated for ±600 VRMS, maximum; operation of Isolated Analog Interface signals should be at SELV safety voltage conditions to chassis ground.

2.13.2 Remote External user control interface

The Remote External user control interface is located on the rear panel. Figure 2-12 shows the rear panel view of the connector, and Table 2-13 lists the connector type. Table 2-14 shows the functions and Table 2-15 shows the connector pinout.

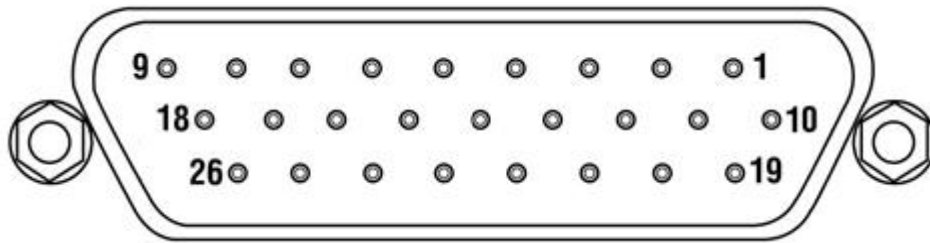

Figure 2-12: External User Control Interface connector

Connector	Type
Remote External User Control Interface	high-density, 26-contact, female D-Type, Norcomp P/N 181-026-213R531 Mating connector, Norcomp P/N 180-026-103L001

Table 2-13: External User Control Interface connector Type

Function	Characteristics
Remote Output ON/OFF Control	Each channel is provided with control inputs to turn output ON/OFF the power supply. DC Input (+) 2.7 V-24 V will enable (turn-on) the output of the supply.

Remote Inhibit Input	<p>Switch/Relay contact closure or direct short from this terminal to signal return is required to Turn ON/OFF the power supply. Opening the contact would shut down the output and would be latched after reclosing the contact, user needs to turn ON the output.</p> <p>Remote circuit must sink up to 10 mA from 5 VDC to enable.</p>
TRIGGER IN	<p>TTL compatible Input signal, active-high; provides external hardware triggering of voltage, current ramp and sequencing functions.</p> <p>Signal connects to Open-anode of opto-isolator diode with internal 1kΩ series resistor internal to power supply.</p> <p>Voltage Rating: Maximum 24 V, Minimum -5V</p> <p>Low state: 0.3 V max, High State 2.7 V min</p>
TRIGGER OUT	<p>Output signal, active-high; synchronization pulse of 10 ms when a change in the output occurs.</p> <p>Open collector transistor output, Collector is connected the 26-pin connector. Emitter point of transistor is connected to common return pin of the interface connector.</p> <p>Voltage Rating: Maximum 30 V, Minimum 3V for Active High, Sink Current: 50mA</p>
CC/CV status Output	<p>Output signal, High state indicates Constant Current mode operation and Low state indicates Constant Voltage mode operation.</p> <p>Open collector transistor output, Collector is connected the 26-pin connector. Emitter point of transistor is connected to common return pin of the interface connector.</p> <p>Voltage Rating: Maximum 30 V, Minimum 3V for Active High, Sink Current: 50mA</p>
Output ON/OFF Status	<p>Output signal, High state indicates Channel Output is ON and Low state indicates Channel Output is OFF</p> <p>Open collector transistor output, Collector is connected the 26-pin connector. Emitter point of transistor is connected to common return pin of the interface connector.</p> <p>Voltage Rating: Maximum 30 V, Minimum 3V for Active High, Sink Current: 50mA</p>
FAULT	<p>Output Signal, High state indicates fault state of the power supply.</p> <p>Open collector transistor output, Collector is connected the 26-pin connector. Emitter point of transistor is connected to common return pin of the interface connector.</p> <p>Voltage Rating: Maximum 30 V, Minimum 3V for Active High, Sink Current: 50mA</p>
Isolation voltage External User Control Interface Signals to Output Negative terminal	<p>$\pm 600 V_{RMS}$, maximum; External User Control Interface Signals are isolated from negative output terminal; operation of Isolated Analog Interface signals should be at SELV safety voltage conditions to chassis ground.</p>

Table 2-14: External User Control Interface Characteristics

Pin	Signal	Type	Description
Channel-1 Signals (Pin number 1 to 9)			
1	TRIG1-IN	DIGITAL INPUT	Input signal, TTL active-high; provides external hardware triggering of voltage and current ramp functions.



			<p>Signal connects to Open-anode of opto-isolator diode with 1kΩ series resistor internal to power supply.</p> <p>Signal return: Pin 8</p> <p>Voltage Rating: Maximum 24V, Minimum -5V</p> <p>Low state 0.3V max, High State 2.7V min.</p>
2	TRIG1-OUT	DIGITAL OUTPUT	<p>Output signal, active-high; synchronization pulse of 10 ms when a change in the output occurs.</p> <p>Open collector transistor output, Collector is connected the 26-pin connector. Emitter point of transistor is connected to common return pin of the interface connector.</p> <p>Signal return: Pin 8</p> <p>Voltage Rating: Maximum 30V, Minimum 3V for Active High, Sink Current: 50mA</p>
3	CH1-FAULT-STATUS	DIGITAL OUTPUT	<p>Output Signal, High state indicates fault state of the power supply.</p> <p>Open collector transistor output, Collector is connected the 26-pin connector. Emitter point of transistor is connected to common return pin of the interface connector.</p> <p>Signal return: Pin 8</p> <p>Voltage Rating: Maximum 30V, Minimum 3V for Active High, Sink Current: 50mA</p>
4	CH1-OUTPUT-ON-OFF	DIGITAL INPUT	<p>Remote-control input for output on/off with a logic signal: a logic-high, will enable (turn-on) the output of the supply, and a logic-low signal disables (turns off) the output.</p> <p>Signal connects to Open-anode of opto-isolator diode with 1kΩ series resistor internal to power supply</p> <p>Signal return: Pin 8</p> <p>Voltage Rating: Maximum 24V, Minimum -5V</p> <p>Low state 0.3V max, High State 2.7V min.</p>
5	CH1-CV/CC-STATUS	DIGITAL OUTPUT	<p>User digital output. Output low for Constant Voltage (CV) mode and high for Constant Current (CC) mode.</p> <p>Open collector transistor output, Collector is connected the 26-pin connector. Emitter point of transistor is connected to common return pin of the interface connector.</p> <p>Signal return: Pin 8</p> <p>Voltage Rating: Maximum 30V, Minimum 3V for Active High, Sink Current: 50mA</p>
6	CH1-OUTPUT-ON/OFF-STATUS	DIGITAL OUTPUT	<p>Output Signal, High state indicates output of the power supply is enabled.</p> <p>Open collector transistor output, Collector is connected the 26-pin connector. Emitter point of transistor is connected to common return pin of the interface connector.</p> <p>Signal return: Pin 8</p> <p>Voltage Rating: Maximum 30V, Minimum 3V for Active High, Sink Current: 50mA.</p>
7	CH1-Remote Inhibit	Input Switch/ Relay Contact	<p>Switch/Relay contact closure or direct short from this terminal to signal return is required to enable/disable the output of the power supply. Opening the contact would disable the output. Upon contact closure, if remote inhibit is selected as live mode, the fault would be cleared, and output could be enabled from the front panel or by issuing the SCPI command.</p> <p>If remote inhibit is selected as Latch mode, the output will be disabled, Output could not be enabled upon the contact closure. Fault should be cleared by</p>

			<p>issuing the SCPI command <code>OUTP<n>:PROT:CLE</code> or by clearing the fault from the front panel screen.</p> <p>Remote circuit must sink up to 10mA from 5 VDC to enable.</p> <p>Signal return: Pin 8</p>
8	RTN	RETURN	Return/GND. Pins 8,17 and 26 are shorted internal to the power supply.
9	NC	N/A	No Connection
Channel-2 Signals (Pin number 10 to 18)			
10	TRIG2-IN	DIGITAL INPUT	<p>Input signal, TTL active-high; provides external hardware triggering of voltage and current ramp functions.</p> <p>Signal connects to Open-anode of opto-isolator diode with 1kΩ series resistor internal to power supply.</p> <p>Signal return: Pin 17</p> <p>Voltage Rating: Maximum 24V, Minimum -5V</p> <p>Low state 0.3V max, High State 2.7V min.</p>
11	TRIG2-OUT	DIGITAL OUTPUT	<p>Output signal, active-high; synchronization pulse of 10 ms when a change in the output occurs.</p> <p>Open collector transistor output, Collector is connected the 26-pin connector. Emitter point of transistor is connected to common return pin of the interface connector.</p> <p>Signal return: Pin 17</p> <p>Voltage Rating: Maximum 30V, Minimum 3V for Active High, Sink Current: 50mA</p>
12	CH2-FAULT-STATUS	DIGITAL OUTPUT	<p>Output Signal, High state indicates fault state of the power supply.</p> <p>Open collector transistor output, Collector is connected the 26-pin connector. Emitter point of transistor is connected to common return pin of the interface connector.</p> <p>Signal return: Pin 17</p> <p>Voltage Rating: Maximum 30V, Minimum 3V for Active High, Sink Current: 50mA</p>
13	CH2-OUTPUT-ON-OFF	DIGITAL INPUT	<p>Remote-control input for output on/off with a logic signal: a logic-high, will enable (turn-on) the output of the supply, and a logic-low signal disables (turns off) the output.</p> <p>Signal connects to Open-anode of opto-isolator diode with 1kΩ series resistor internal to power supply</p> <p>Signal return: Pin 17</p> <p>Voltage Rating: Maximum 24V, Minimum -5V</p> <p>Low state 0.3V max, High State 2.7V min.</p>
14	CH2-CV/CC-STATUS	DIGITAL OUTPUT	<p>User digital output. Output low for Constant Voltage (CV) mode and high for Constant Current (CC) mode.</p> <p>Open collector transistor output, Collector is connected the 26-pin connector. Emitter point of transistor is connected to common return pin of the interface connector.</p> <p>Signal return: Pin 17</p> <p>Voltage Rating: Maximum 30V, Minimum 3V for Active High, Sink Current: 50mA</p>
15	CH2-OUTPUT-ON/OFF-STATUS	DIGITAL OUTPUT	<p>Output Signal, High state indicates output of the power supply is enabled.</p> <p>Open collector transistor output, Collector is connected the 26-pin connector. Emitter point of transistor is connected to common return pin of the interface connector.</p>

			Signal return: Pin 17 Voltage Rating: Maximum 30V, Minimum 3V for Active High, Sink Current: 50mA.
16	CH2-Remote Inhibit	Input Switch/ Relay Contact	Switch/Relay contact closure or direct short from this terminal to signal return is required to enable/disable the output of the power supply. Opening the contact would disable the output. Upon contact closure, if remote inhibit is selected as live mode, the fault would be cleared, and output could be enabled from the front panel or by issuing the SCPI command. If remote inhibit is selected as Latch mode, the output will be disabled, Output could not be enabled upon the contact closure. Fault should be cleared by issuing the SCPI command <code>OUTP<n>:PROT:CLE</code> or by clearing the fault from the front panel screen. Remote circuit must sink up to 10mA from 5 VDC to enable. Signal return: Pin 17
17	RTN	RETURN	Return/GND. Pins 8,17 and 26 are shorted internal to the power supply.
18	NC	N/A	N/A
Channel-3 Signals (Pin number 19 to 26)			
19	TRIG3-IN	DIGITAL INPUT	Input signal, TTL active-high; provides external hardware triggering of voltage and current ramp functions. Signal connects to Open-anode of opto-isolator diode with 1kΩ series resistor internal to power supply. Signal return: Pin 26 Voltage Rating: Maximum 24V, Minimum -5V Low state 0.3V max, High State 2.7V min.
20	TRIG3-OUT	DIGITAL OUTPUT	Output signal, active-high; synchronization pulse of 10 ms when a change in the output occurs. Open collector transistor output, Collector is connected the 26-pin connector. Emitter point of transistor is connected to common return pin of the interface connector. Signal return: Pin 26 Voltage Rating: Maximum 30V, Minimum 3V for Active High, Sink Current: 50mA
21	CH3-FAULT-STATUS	DIGITAL OUTPUT	Output Signal, High state indicates fault state of the power supply. Open collector transistor output, Collector is connected the 26-pin connector. Emitter point of transistor is connected to common return pin of the interface connector. Signal return: Pin 26 Voltage Rating: Maximum 30V, Minimum 3V for Active High, Sink Current: 50mA
22	CH3-OUTPUT-ON-OFF	DIGITAL INPUT	Remote-control input for output on/off with a logic signal: a logic-high, will enable (turn-on) the output of the supply, and a logic-low signal disables (turns off) the output. Signal connects to Open-anode of opto-isolator diode with 1kΩ series resistor internal to power supply Signal return: Pin 26 Voltage Rating: Maximum 24V, Minimum -5V Low state 0.3V max, High State 2.7V min.
23	CH3-CV/CC-STATUS	DIGITAL OUTPUT	User digital output. Output low for Constant Voltage (CV) mode and high for Constant Current (CC) mode.

			<p>Open collector transistor output, Collector is connected the 26-pin connector. Emitter point of transistor is connected to common return pin of the interface connector.</p> <p>Signal return: Pin 26</p> <p>Voltage Rating: Maximum 30V, Minimum 3V for Active High, Sink Current: 50mA</p>
24	CH3-OUTPUT-ON/OFF-STATUS	DIGITAL OUTPUT	<p>Output Signal, High state indicates output of the power supply is enabled.</p> <p>Open collector transistor output, Collector is connected the 26-pin connector. Emitter point of transistor is connected to common return pin of the interface connector.</p> <p>Signal return: Pin 26</p> <p>Voltage Rating: Maximum 30V, Minimum 3V for Active High, Sink Current: 50mA.</p>
25	CH3-Remote Inhibit	Input Switch/Relay Contact	<p>Switch/Relay contact closure or direct short from this terminal to signal return is required to enable/disable the output of the power supply. Opening the contact would disable the output. Upon contact closure, if remote inhibit is selected as live mode, the fault would be cleared, and output could be enabled from the front panel or by issuing the SCPI command.</p> <p>If remote inhibit is selected as Latch mode, the output will be disabled, Output could not be enabled upon the contact closure. Fault should be cleared by issuing the SCPI command <code>OUTP<n>:PROT:CLE</code> or by clearing the fault from the front panel screen.</p> <p>Remote circuit must sink up to 10 mA from 5 VDC to enable.</p> <p>Signal return: Pin 26</p>
26	RTN	RETURN	Return/GND. Pins 8,17 and 26 are shorted internal to the power supply.

Table 2-15: External User Control Interface Pin Out details

	<p>CAUTION!</p> <p>All the three channels signal returns (Pin 8, 17 and 26) are shorted internally to the power supply. Applying a voltage potential between them would damage the power supply.</p>
	<p>CAUTION!</p> <p>External User Control interface signals are isolated from negative output terminal; Isolation voltage is rated for ±600 VRMS, maximum; operation of Isolated Analog Interface signals should be at SELV safety voltage conditions to chassis ground.</p>

2.13.3 RS-232C Serial Interface

RS-232C Figure 2-13, Table for connector type and Table 2-17 for pin descriptions. The power source functions as Data Circuit-terminating Equipment (DCE). The cable connecting to the Data Terminal Equipment (DTE) should be straight-through (one-to-one contact connections). For EMC considerations a ferrite core can be added to the cable Ametek P/N: 991-642-28, Manufacturer P/N: CS28B0642. Refer to the DC-Asterion Multioutput Series Programming Manual P/N M330517-01 distributed on the CD, M550008-01 for establishing communication from the computer.

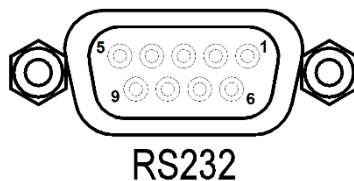

Figure 2-13: RS-232C Interface Connector

Connector	Type
RS-232C Interface	9-contact receptacle (female) Subminiature-D.

Table 2-16: RS-232C Interface Connector Type

Pin #	Name	DCE Signal	Direction
1	N/C	N/A	N/A
2	TxD	Transmit Data	Output
3	RxD	Receive Data	Input
4	N/C	N/A	N/A
5	Common	N/A	N/A
6	N/C	N/A	N/A
7	RTS	Request to Send	Input
8	CTS	Clear to Send	Output
9	N/C	N/A	N/A

Table 2-17: RS-232C Interface Connector Pinout

2.13.4 USB interface

USB remote control interface is made through a Series-B device connector located on the rear panel; refer to Figure 2-14 for view of connector, Table 2-18 for the connector type and Table 2-19 for pin descriptions. A standard USB cable between the Asterion Series power source and a computer should be used. For EMC considerations a ferrite core can be added to the cable Ametek P/N: 991-642-28, Manufacturer P/N: CS28B0642. Refer to the DC-Asterion Multioutput Series Programming Manual P/N M330517-01 distributed on the CD, M550008-01 for establishing communication from the computer.



CAUTION!

Connecting the power source to the computer controller through an USB hub is not recommended. The USB connection should be direct between the two devices.

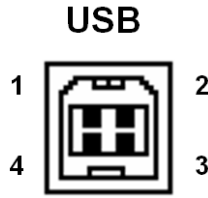

Figure 2-14: USB Interface Connector

Connector	Type
USB Interface	USB series-B type Connector

Table 2-18: USB Interface Connector Type

Pin #	Name	Description
1	N/C	No Connection
2	D-	Data -
3	D+	Data +
4	GND	Ground

Table 2-19: USB Interface Connector Pinout

2.13.5 LAN interface

A LAN connector (Ethernet 10BaseT/100BaseT) is located on the rear panel for remote control; refer to Figure 2-15 for view of connector, Table 2-20 for connector type and Table 2-21 for pin descriptions. A standard modular cable with an 8P8C modular plug should be used between the power source and a network hub. For a direct connection to a computer LAN card, a crossover cable with an 8P8C modular plug is required. The MAC Address (Media Access Control) of the Ethernet port is printed on a label on the chassis of the power source. For information on how to set up a network connection or a direct computer connection using the LAN interface, refer to the DC-Asterion Multioutput Series Programming Manual P/N M330517-01 distributed on the CD, M550008-01. For EMC considerations a ferrite core can be added to the cable Ametek P/N: 991-642-28, Manufacturer P/N: CS28B0642.

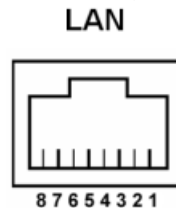

Figure 2-15: LAN Interface 8P8C Modular Connector

Connector	Type
LAN Interface	Standard RJ45 connector

Table 2-20: LAN Interface Connector Type

Pin #	Ethernet Signal	EIA/TIA 568A	EIA/TIA 568B Crossover
1	Transmit/Receive Data 0 +	White with green stripe	White with orange stripe
2	Transmit/Receive Data 0 -	Green with white stripe or solid green	Orange with white stripe or solid orange
3	Transmit/Receive Data 1 +	White with orange stripe	White with green stripe
4	Transmit/Receive Data 2 +	Blue with white stripe or solid blue	Blue with white stripe or solid blue
5	Transmit/Receive Data 2 -	White with blue stripe	White with blue stripe
6	Transmit/Receive Data 1 -	Orange with white stripe or solid orange	Green with white stripe or solid green
7	Transmit/Receive Data 3 +	White with brown stripe or solid brown	White with brown stripe or solid brown
8	Transmit/Receive Data 3 -	Brown with white stripe or solid brown	Brown with white stripe or solid brown

Table 2-21: LAN Interface 8P8C Modular Connector Pinout

2.13.6 GPIB interface

A GPIB connector is located on the rear panel for remote control; refer to Figure 2-16 for rear view of connector, Table 2-22 for connector type and Table 2-23 for pin descriptions. Refer to the DC-Asterion Multioutput Series Programming Manual P/N M330517-01 distributed on the CD, M550008-01 for establishing communication.



Figure 2-16: GPIB interface Connector

Connector	Type
GPIB Interface	PCB D-Sub Connectors, Receptacle, Cable-to-Board, 24 Position TE Connectivity P/N: 5554923-1

Table 2-22: GPIB Interface Connector Type

Pin #	GPIB Signal	Description
1	DIO1	Data Input/ Output bit
2	DIO2	Data Input/ Output bit
3	DIO3	Data Input/ Output bit

Pin #	GPIB Signal	Description
4	DIO4	Data Input/ Output bit
5	EOI	End- Or- Identity
6	DAV	Data Valid
7	NRFD	Not Ready for Data
8	NDAC	Not Data Accepted
9	IFC	Interface Clear
10	SRQ	Service Request
11	ATN	Attention
12	SHIELD	Tied to Digital Ground
13	DIO5	Data Input/ Output bit
14	DIO6	Data Input/ Output bit
15	DIO7	Data Input/ Output bit
16	DIO8	Data Input/ Output bit
17	REN	Remote Enable
18	GND	Digital Ground
19	GND	Digital Ground
20	GND	Digital Ground
21	GND	Digital Ground
22	GND	Digital Ground
23	GND	Digital Ground
24	GND	Digital Ground

Table 2-23: GPIB Interface Connector Pinout

3 OPERATION

3.1 Introduction

The Asterion Multioutput DC ASA Series is operated from the intuitive, easy-to-use front panel touch screen display. Provides Quick access to output programming parameters, measurements, ramp, configuration, control interface and system settings from the touch screen interface. Functions and parameters can be directly selected from the touch screen or by using the encoder selector button. The following sections provides detailed information of the controls, indicators, and the front panel menu functionalities for the operation of the power supply.

3.2 Front Panel Controls and LED Indicators

Figure 3-1 shows a view of the front panel of the DC-Asterion multioutput series. Refer to Table 3-1 for functional descriptions of the front panel.

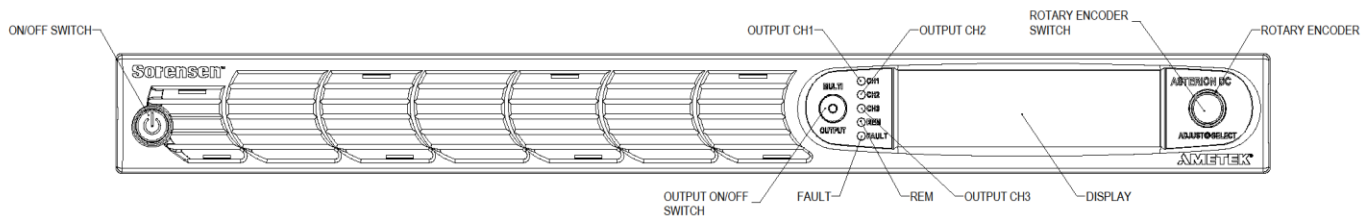

Figure 3-1: Front panel DC-Asterion Multioutput Series

Item	Reference	Functional Description
1	ON/OFF Switch	<p>Two-position pushbutton switch turns the source on and off.</p> <div style="border: 1px solid black; padding: 5px;">  <p>WARNING! OFF position does not remove AC input from internal circuits. Disconnect external AC input before servicing unit</p> </div>
2	OUTPUT ON/OFF Switch	Momentary switch that toggles the selected channel output power ON/OFF. Channel can be selected through front panel dashboard screen, refer Figure 3-20.
3	Display	TFT color graphics display with backlight and pressure-actuated touch-screen. menu-driven settings and functions.
4	Rotary Encoder	Navigates between and within screens; scrolls through functions and selects numerical values; adjusts output parameters in real-time.
5	Rotary Encoder Switch	Momentary-action switch that selects functions and enters numerical values.
LED Mode Indicators		Indicates the mode that is active:
6	OUTPUT CH1	Output Channel 1 is turned on.
7	OUTPUT CH2	Output Channel 2 is turned on.
8	OUTPUT CH3	Output Channel 3 is turned on.
10	REM	Source is presently controlled by the remote digital interface. If the RS-232C, USB, GPIB or LAN interface is used, the REM state can be enabled by the external controller using the SCPI command, SYST:REM. Any time the REM LED is lit, the front panel control of the unit is disabled. To regain control through the front panel, the external controller must send the SCPI command, SYST:LOC.
11	FAULT	Fault condition has occurred; output is shutdown, and output voltage is programmed to zero.

Table 3-1: Front Panels controls and indicators

3.3 Basic Front Panel Operation

The Asterion DC Multioutput ASA Series power source provides extensive functionality and programmability, which could be exercised through the front panel, and the remote analog/digital control interface. This section provides basic details such as Navigation, Menu selection, Rotary encoder and Soft numeric keyboard which are common to all screens.

The Asterion DC Multioutput ASA Series power supply is shipped from the factory configured for front panel (local) voltage/current/overvoltage Protection control, and with the remote sense not connected (default to internal local voltage sensing at chassis output terminals). The remote sense leads must be connected externally by the user to achieve

performance specifications. The external user interface connector (26 pin connector) is supplied with a mating connector which has the remote inhibit input output ON/OFF control signals for all the 3 channels connected (Pin-7 shorted to Pin-8 to enable channel-1, Pin-16 shorted to Pin-17 to enable channel-2, Pin-25 shorted to Pin-26 to enable channel-3) to allow the output to be enabled.

WARNING!



The power-up factory default state is output enabled, and the output will be energized with the settings of voltage and current at zero. At initial power-on a screen is displayed with a warning that the output will be enabled after countdown of a 10-second timer; during this state, the output Voltage and Current are programmed to zero, the Overvoltage Protection (OVP) is set to maximum, and the Output State is OFF. After the 10-second timer has elapsed, the Output State is changed to ON. Refer to Figure 3-15 or the warning screen that is displayed on the course of boot up of the power supply.

3.3.1 Initial Setup

Before connecting the unit to the AC mains, ensure that the front panel ON/OFF power switch is in the **OFF** position. Check the external user interface connector (26 pin connector) mating connector is fixed on the rear panel and verify that Pins 7 and 8, Pin 16 and Pin 17, Pin 25, and Pin 26 (Remote Inhibit Output On/Off) are shorted together. This is the default configuration installed from the factory. This jumper allows the output of the supply to be enabled from the front panel when the Output On/Off button is pressed.

3.3.2 Front Panel Touch Screen Layout

The Asterion DC Multioutput series supply is a 3-output channel supply and the front panel touch screen layout designed to project three channels' settings and measurements. Each channel layout is differentiated with individual channel color. output channel 1 layout is intended to orange, channel 2 layout is intended to blue and channel 3 layout is intended to green color; refer Figure 3-2 and Figure 3-4. if user orders power supply for 2-output channels then the 3rd channel layout would be grayed out in all top level and sub level menus from front panel touch screen. Refer Figure 3-3 and Figure 3-5.



Figure 3-2: Dashboard screen



Figure 3-3: Dashboard screen with channel 3 layout grayed out

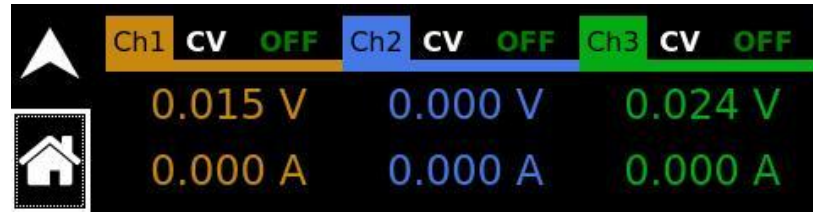

Figure 3-4: Measurement screen

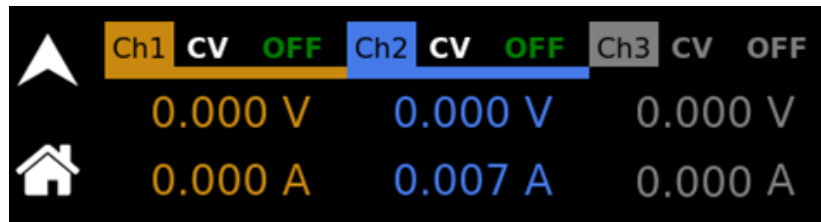



Figure 3-5: Measurement screen with Channel 3 layout grayed out

3.3.3 Navigation and Selection

The front panel display of the Asterion DC Multioutput ASA Series power source allows the user to select the various menus required to configure and operate the unit. Navigating through the various menus could be done using the touch-screen display or the rotary encoder. Tapping the display screen or clicking with the encoder on any menu or function that is highlighted (active) will enter that menu or execute that function.

The touch-screen utilizes resistive, pressure-actuated technology, and depends on pressure being applied to the top surface of the screen to detect the position of input. A fingertip, fingernail, or stylus pen could be used. To prevent scratching the surface layer, do not use a hard or sharp tip, such as ball-point pen or mechanical pencil.



CAUTION! Damage or scratching of the touch-screen could occur if excessive pressure is applied to the surface, or if objects with hard/sharp tips are used.

The present cursor position is always shown with a selection-box that has a highlighted border around a field, refer to Figure 3-6 and Figure 3-7. Some screens have multiple pages, as indicated by the highlighted Arrow icons located on the right side of the screen.

Tapping an Arrow or selecting it with the rotary encoder and clicking the switch, scrolls the screen to the next page. When outside one of the HOME screens, tapping the Home icon will exit that screen and would return to the HOME screen. Refer to Figure 3-7 and Figure 3-6 respectively.

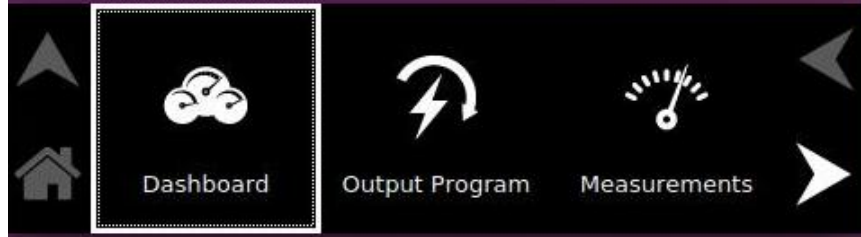

Figure 3-6: Home Screen with Dashboard Icon Highlighted



Figure 3-7: Dashboard Screen with Home Button Selected



Figure 3-8: Dashboard Screen with Channel-1 selected

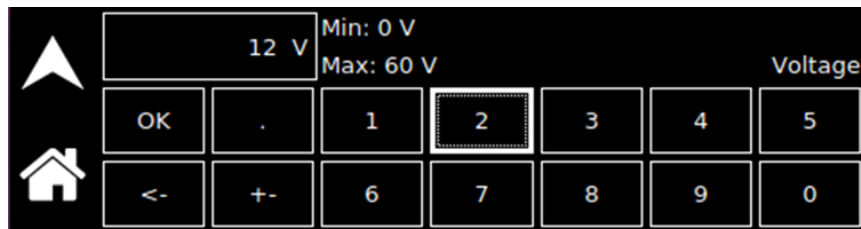

Figure 3-9: Touch-Screen Numeric Keypad

The Dashboard Menu is shown with Channel 1 selected (Refer to Figure 3-8) with voltage and current selection field highlighted active. Tapping the selection-field box, selects that parameter for adjustment, and the screen changes to the numeric keypad that allows value entry; Refer to Figure 3-11.

Another way of entering the value is by scrolling to the parameter selection-field and depressing with encoder switch, parameter selection- field active has its border highlighted in bold when selected using the encoder switch; refer to Figure 3-10, current selection field is selected by encoder switch and the border is highlighted in Bold lines. Upon selection then user can continuously adjust the parameter value, up and down, as the encoder is rotated, and the encoder switch is depressed again this will set the value on the parameter field.



Figure 3-10: DASHBOARD Screen Current Selection-Field Active using Encoder switch

3.3.4 Touch-Screen Numeric Keypad

The touch-screen has a keypad that allows numeric value entry; refer to Figure 3-11. After scrolling through menus until a parameter selection-field box is highlighted (active), tapping the selection-field selects it. Afterwards, the keypad screen will be displayed. Tapping numerical value keys, the decimal point key, or the polarity key, selects them, while the back-arrow key erases the last entry. To enter a negative value, first enter the number then the minus sign. The selected values appear in the upper-left parameter window, and the cursor moves to the next available position. Tapping the OK key enters the value to have it take effect.

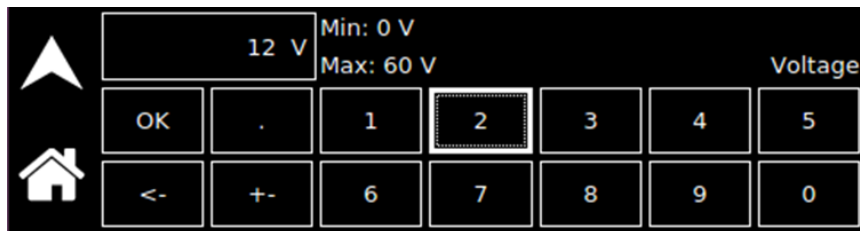

Figure 3-11: Touch-Screen Numeric Keypad

Functions that accept a numeric value require that the value is within the allowed range, otherwise, an error will be generated, and the value will not be accepted.

3.3.5 Rotary Encoder

The rotary encoder provides a secondary way to navigate the display. It is used to select functions, change parameter values, and perform setup. It can be used to move between menu screens and between editable items within an individual menu screen.

The rotary encoder is located on the front panel and provides continuous adjustment in the clockwise and counter-clockwise rotation; refer to Figure 3-12. Turning the encoder knob allows sequential scrolling through each menu or function on a screen; the item that is active has its selection field-box highlighted bold; Refer Figure 3-10. To select or set a choice, depress the encoder knob to engage the encoder momentary switch.

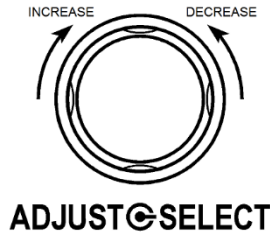

Figure 3-12: Rotary Encoder

The rotary encoder can operate in one of two distinct modes:

MODE	DESCRIPTION
NAVIGATE	The rotary encoder can be used to scroll through menu screen functions and settings. The current (active) selected item will be outlined in a highlighted selection-field box. As the encoder is rotated, the highlighted box will be scrolled through all items on a screen that could be selected; refer Figure 3-8.
ADJUST/SELECT	<p>After scrolling to a function, the rotary encoder knob is depressed to select the function (clicking on an item). Clicking on a selection-button will change its state (on or off) and clicking on a function or menu will select it and change to a screen that allows further value entry.</p> <p>Parameter values, such as voltage and current, are adjusted by navigating to the parameter text box and depressing on the text box will select the parameter text box. screen will be displayed with a parameter selection-field border highlighted bold (refer to Figure 3-10). If a parameter selection-field had been selected whose value could be adjusted by Rotary Encoder switch, the rotary encoder could then be used to continuously adjust the parameter value, up and down, as the encoder is rotated, and the encoder switch is depressed again this will set the parameter value. Click the encoder a second time to enter the value. If the OUTPUT switch is on, the output parameter will change when the encoder is clicked.</p>

The DASHBOARD screen menu has the capability for real-time adjustment of output parameters: the value of the parameters change as the rotary encoder is turned for immediate effect at the output. If the OUTPUT switch is on, the output parameter will change as the encoder is rotated. Refer to the DASHBOARD screen menu in Section 3.4.3 for a description of the parameters that have real-time adjustability.

The rotary encoder could also be used with the numeric keypad to enter values. After selecting a parameter using the touch-screen, the numeric keypad will be displayed; refer to Figure 3-11. The rotary encoder could be used to select any of the items of the numeric keypad by scrolling through them and clicking on them with the encoder switch to select them. The active value is identified on the screen with a highlighted field-box, and the entered decimal places are shown in the upper-left window. The cursor moves to the next available position as values are entered. After the desired decimal places are entered sequentially, the OK key is clicked to execute the final value and have it take effect.

3.4 Front Panel Display Menu and Functionality

3.4.1 Power-Up Screens

At initial power-on, the display shows the Asterion DC Multioutput Splash screen, Refer to Figure 3-13, followed by the Start-Up screen with the manufacturer name, model number, serial number, firmware revisions and last calibration date, Refer to Figure 3-14, and finally the Dashboard screen, Refer to Figure 3-20.



Figure 3-13: Splash Screen

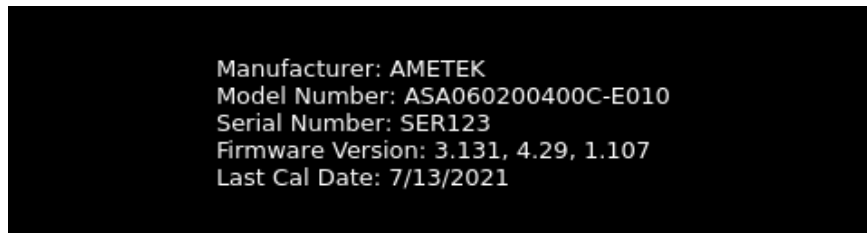

Figure 3-14: Power-On Screen Displaying Model & Version

If output is enabled in Power-ON Settings (PONS) screen for any of the channel, refer to Figure 3-63 and supply is in Local mode, a warning screen is shown, Refer to Figure 3-15, before the Dashboard Screen.

It warns the user that the output will be enabled at the end of 10 second countdown. The process can be aborted by pressing the ABORT button on the screen. If the ABORT button is pressed ABORTING status screen will be shown. Refer Figure 3-16.

Once aborted, the output remains off until the user enables it with the Output On/Off button.

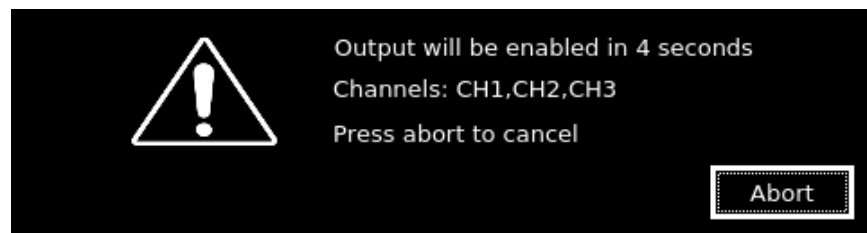

Figure 3-15: Output-Enabled Warning Screen

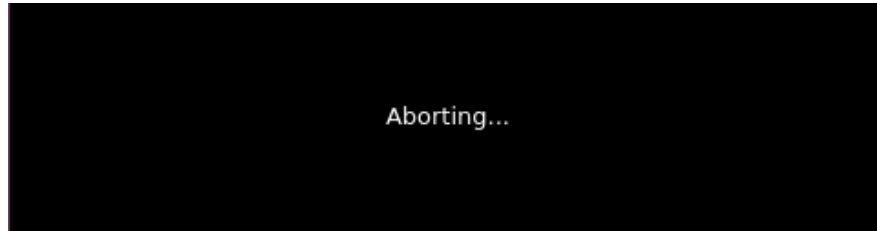

Figure 3-16: Abort Status Screen

3.4.2 Home Screen Top-Level Menu

Selecting the Home icon or Up arrow will open the HOME screen. Each menu of a screen could be selected by tapping its associated selection-field box through the touch-screen, or by selecting it with the rotary encoder and depressing (clicking) the rotary encoder SELECT switch. Refer to Figure 3-17, Figure 3-18, Figure 3-19 and Table 3-2.

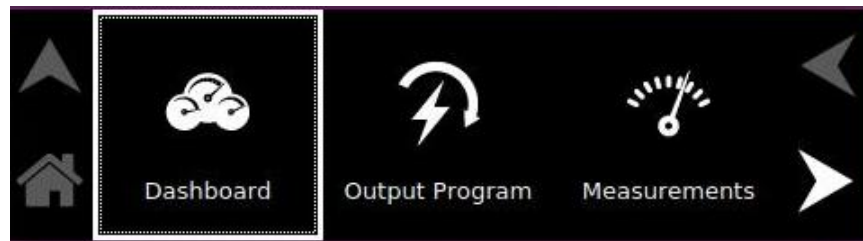

Figure 3-17: HOME Screen Menu 1

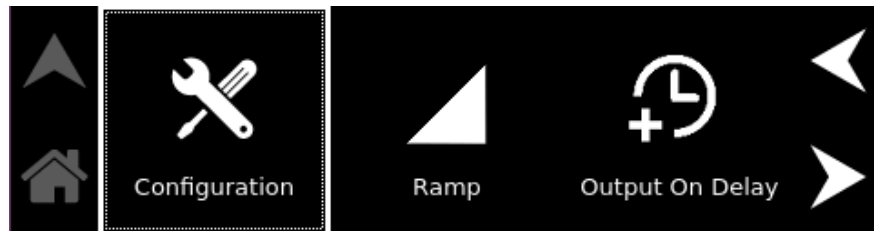

Figure 3-18: HOME Screen Menu 2

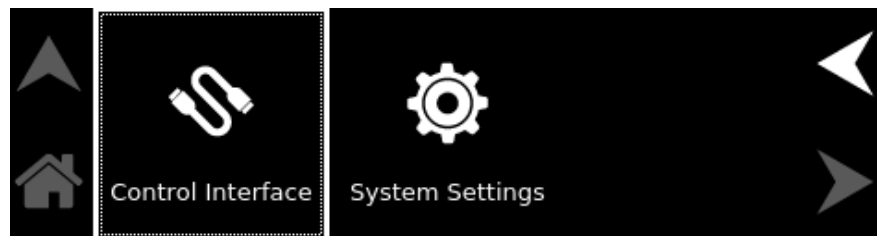

Figure 3-19: HOME Screen Menu 3

There are four virtual buttons visible on a screen: UP, LEFT, and RIGHT arrows, and HOME icon. Those buttons that are highlighted are active for the screen being displayed. The arrow buttons will scroll to the next page of the menu structure in the direction indicated. The HOME button will return to the previous home screen that has the top-level menu from which a sub-menu was entered. The HOME button is no longer functional once a home screen is entered.

The following top-level menu choices can be accessed through the touchscreen:

Top-Level Screen Menu	Menu Description
DASHBOARD	Provides setting and measurement of output parameters: voltage and current for individual channels.
OUTPUT PROGRAM	Provides setting of voltage, current, power, Regulation Mode, Output state, and OVP (Over Voltage Protection) for individual channels.
MEASUREMENT	Provides Measurements of Output Voltage and Current, Output State and Regulation Mode for individual channels.
CONFIGURATION	Provides setup of Power ON States (PONS) , User V/I limit and Measurement Settings for individual channels.
RAMP	Provides Voltage and Current Ramp functions for individual channels.
OUTPUT ON DELAY	Provides setup to Turn ON all three channels Output individually in a sequence with specified time delay.
CONTROL INTERFACE	Provides setup of remote digital interfaces: RS232, GPIB, LAN, Analog, and USB.
SYSTEM SETTINGS	Provides display of firmware versions, hardware parameter limits, brightness of the display, Factory Default settings, Last calibrated Date, System status for individual channels and default screen timeout.

Table 3-2: Home Screen Menu Content

3.4.2.1 NAVIGATING BETWEEN HOME SCREEN MENUS

Each menu in the Home Screen can be reached in one of two ways:

- Tapping selected menu on Home Screen of the front panel touchscreen.
- Scrolling to menu with the encoder and depressing the encoder switch.

Tapping the Up-arrow button will return to the previously selected screen menu. Tapping the HOME button will return to the Home Screen.

3.4.3 Dashboard Screen Top-Level Menu

The DASHBOARD screen top-level menu is used to change output parameters and simultaneously view output measurements. The most used output parameters are shown in the DASHBOARD screen menu. The DASHBOARD screen is the default

menu that is displayed after power-on, refer to Figure 3-20. The DASHBOARD screen displays settings and measurement for all three channels.

Active channel is highlighted by its channel color. First channel's settings and measurements are in orange color. Second channel is in blue color and third one is in green color. To program voltage and current of each channel, channel must be selected by tapping on channel button. For example, on tap of channel 3, it gets highlighted, and it turns to green color. Voltage and settings box also turn to green color. Other non-selected channels are in grey color as shown Figure 3-22. Refer to Section 3.4.2.1 for navigating to Dashboard Screen.



Figure 3-20: Dashboard Screen – Channel 1



Figure 3-21: Dashboard Screen – Channel 2



Figure 3-22: Dashboard Screen – Channel 3

The Voltage settings parameter field box would be displayed as EXT in text (refer Figure 3-23) if the corresponding channel Voltage Reference Mode is selected as EXT. User is restricted to program the output voltage from the front panel screen or digital interface. It could be programed only through the analog programming interface.

The Current settings parameter field box would be displayed as EXT in text (External) (refer Figure 3-24) if the corresponding channel Current Reference Mode is selected as EXT. User is restricted to program the output current from the front panel screen or digital interface. It could be programed only through the analog programming interface.



Figure 3-23: Output Voltage as EXT Reference Mode for Channel 1



Figure 3-24: Output Current as EXT Reference Mode for Channel 2



Figure 3-25: Output Voltage and current as EXT Reference Mode for Channel 3

The following selections are available for each channel in the DASHBOARD screen top-level menu.

<u>Entry</u>	<u>Description</u>
<u>Setting</u>	
Voltage	Programs the output voltage of each channel of the supply in volts. Real-time setting is possible using the rotary encoder and touch screen.
Current	Programs the output current of each channel in amps. Real-time setting is possible using the rotary encoder and touch screen.
<u>Measure</u>	
Voltage	Displays the floating-point value of the DC output voltage in volts.
Current	Displays the floating-point value of the DC output current in amps.
CV/CC/CP	Displays if channel operates in CV (Constant Voltage), CC (Constant Current) or CP (Constant Power) mode.
Output State	Displays output state either "ON or OFF" of each channel. ON text shows in Red color and OFF in Green color. To make Output ON/OFF each channel, first channel must be selected by tapping channel box and then

press output button. Specific channel output LED gets turned ON and toggling output button again, LED gets turned OFF.

3.4.3.1 REAL-TIME PARAMETER ADJUSTMENT

The DASHBOARD screen menu provides the capability for output parameter entry that has real-time, immediate effect on the output. This allows manual adjustment of the output parameters where tuning of a value is desired. Enabling this function requires clicking on a parameter selection-field box with the encoder switch to select the parameter and display its selection-field highlighted bold (Voltage selection field) and with a value entry window (refer to Figure 3-26). The rotary encoder could then be used to continuously adjust the parameter value, up and down, as it is rotated. The value change takes immediate effect at the output.

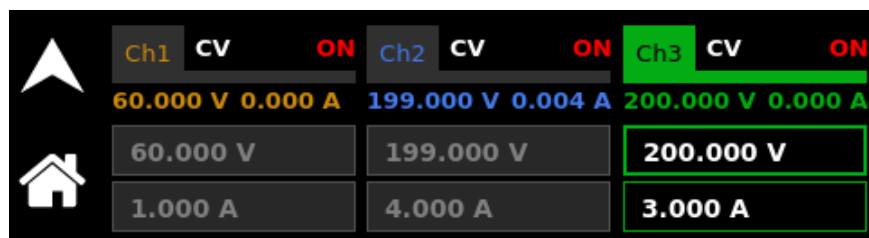

Figure 3-26: Real-Time, Immediate Output Parameter Adjustment

3.4.3.2 TOUCH-SCREEN NUMERIC KEYPAD

The touch-screen has a keypad that allows numeric value entry; refer to Figure 3-27. After scrolling through menus until a parameter selection-field box is highlighted (active), tapping the selection-field selects it. Afterwards, the keypad screen will be displayed. Tapping numerical value keys, the decimal point key, or the polarity key, selects them, while the back-arrow key erases the last entry. To enter a negative value, first enter the number then the minus sign. The selected values appear in the upper-left parameter window, and the cursor moves to the next available position. Tapping the OK key enters the value to have it take effect.

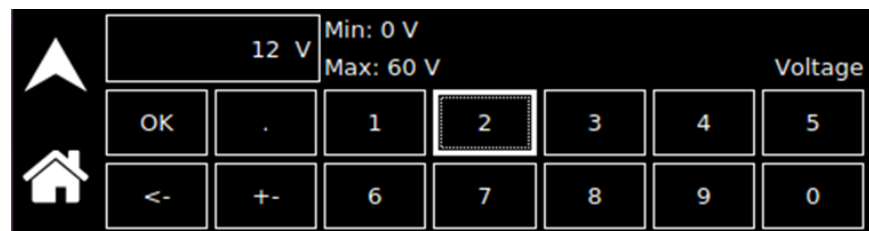

Figure 3-27: Touch-Screen Numeric Keypad

3.4.3.3 DEFAULT SCREEN

The Default screen provides measurement of the DC output voltage, current, output state and CC/CV/CP indication of all channels. refer to Figure 3-28 When in the Dashboard screen, and idle for an interval equal to a set time delay, the display will automatically switch to the Default screen. Tap anywhere on the screen to return to the Dashboard screen (Default Screen).

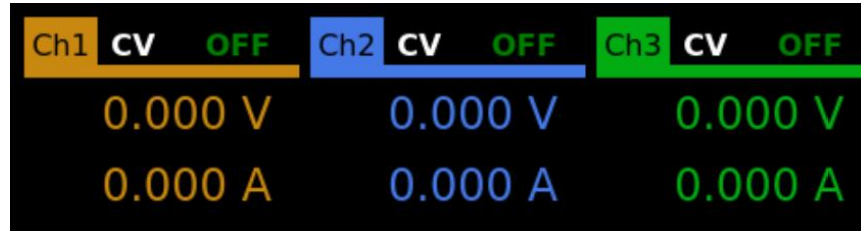

Figure 3-28: Default Screen

With the understanding of the dashboard screen features, user can perform basic functionality and verify the output voltage and output current in various modes of operation as described in Section 3.4.3 (Dashboard Screen).

3.4.4 Output Program

The OUTPUT PROGRAM provides setting of output related items such as individual output Settings, mode of regulation, output state and output sense.

The top-level menu of the Output Program screen is shown in Figure 3-29.

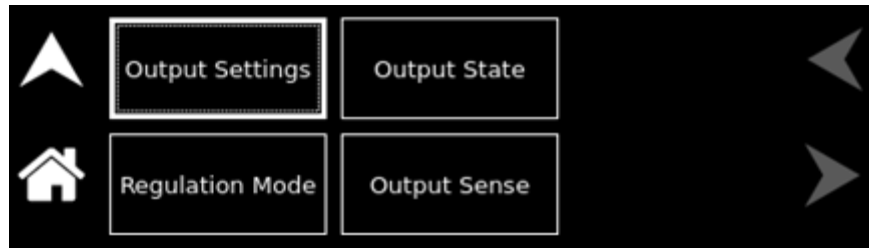

Figure 3-29: OUTPUT PROGRAM Screen Top-Level Menu

3.4.4.1 OUTPUT SETTINGS SCREEN

The OUTPUT PROGRAM sub menu screen provides setting of output related items such as Voltage, Current, Power and Over voltage Protection (OVP) for each channel.

The top-level menu of the Output Settings sub menu screen is shown in Figure 3-30. They could be reached in one of two ways:

1. Tapping the Output Settings on OUTPUT PROGRAM screen of the front panel touch-screen.
2. Scrolling to the Output settings screen with the encoder and depressing the encoder switch.

The Up-arrow button will return to the previously selected screen menu (in this case the OUTPUT PROGRAM screen). The HOME button will return to the HOME screen -1 (refer Figure 3-17).

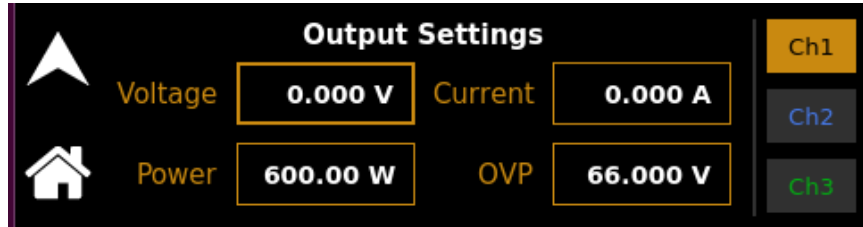

Figure 3-30: Output Settings Screen – Channel 1

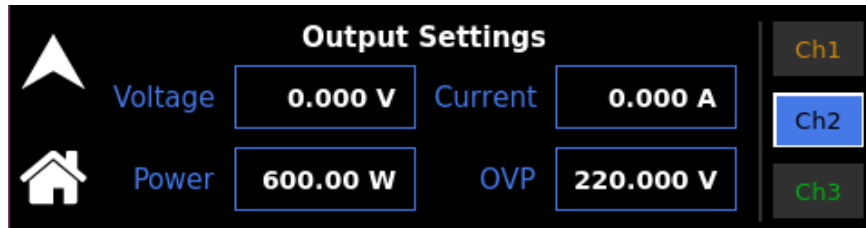

Figure 3-31: Output Settings Screen – Channel 2

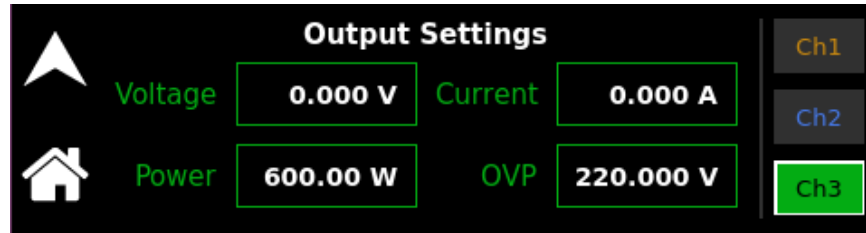

Figure 3-32: Output Settings Screen – Channel 3

The following choices are available in the Output Settings screen. Functions that accept a numeric value require that the value be within the allowed range, otherwise, an error will be generated, and the value will not be accepted.

Entry	Description
Voltage	Programs the output voltage in Volts for respected channel. The default value of each channel would be same that of the programmed power ON settings.
Current	Programs the output current in Amperes for respected channel. The default value of each channel would be same that of the programmed power ON settings.
Power	Programs the output power in watts(W) for respected channel. The default is module power of each channel.
OVP	Programs the Overvoltage Protection (OVP) threshold for the respected channel output voltage. Exceeding the OVP threshold will result in shutdown of the output and the output voltage programmed to zero. The default value of each channel would be same that of the programmed power ON settings.

3.4.4.2 OUTPUT STATE SCREEN

Output state screen provides the functionality to turn Output of each channel either ON or OFF. Selecting Output state submenu in OUTPUT PROGRAM screen (refer Figure 3-29) opens up output state screen as below (Refer to Figure 3-33, Figure 3-34 and Figure 3-35). Refer to Section 3.4.2.1 for navigating from HOME screen to OUTPUT PROGRAM Screen.

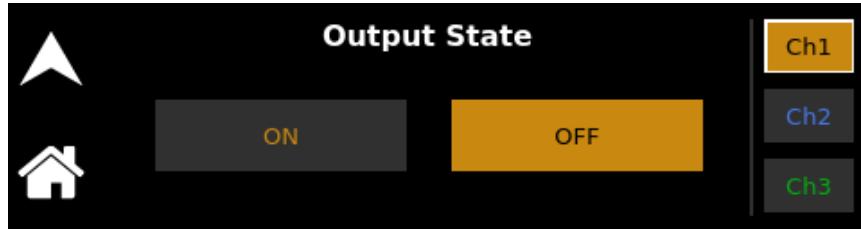

Figure 3-33: Output State Screen – Channel 1

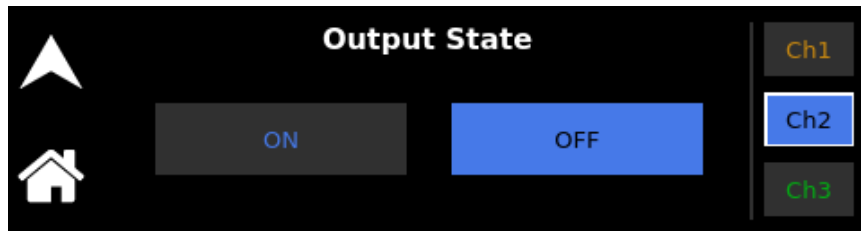

Figure 3-34: Output State Screen – Channel 2

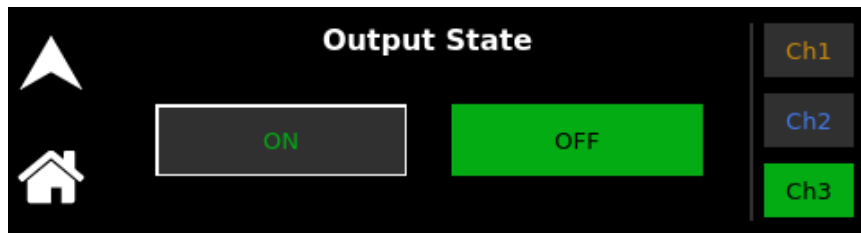

Figure 3-35: Output State Screen – Channel 3

Entry	Description
ON	Programs the output state into ON for selected channel.
OFF	Programs the output state into OFF for selected channel.

3.4.4.3 REGULATION MODE SCREEN

Regulation Mode screen provides functionality to set regulation mode of each channel. Up-arrow will return to previously selected screen and Home button will return to HOME Menu screen-1 (refer Figure 3-17).

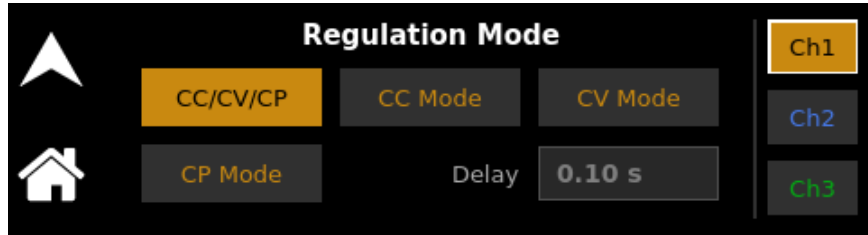

Figure 3-36: Regulation Mode Screen – Channel 1

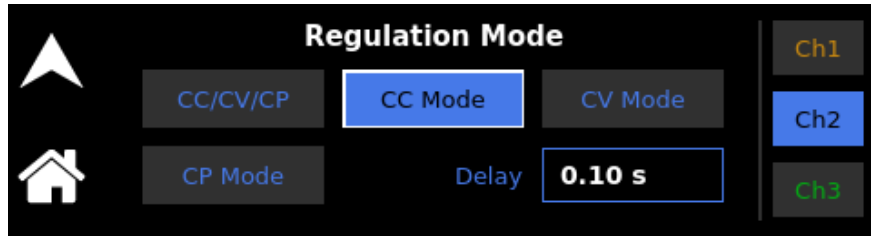

Figure 3-37: Regulation Mode Screen – Channel 2

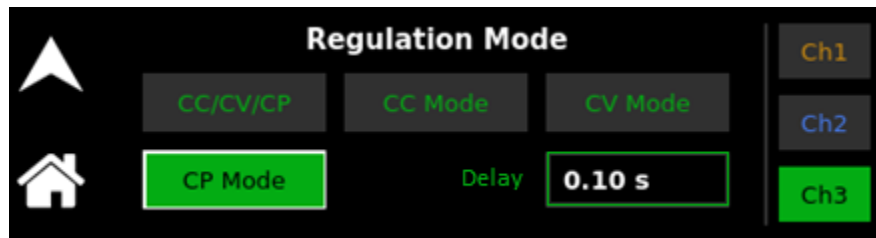

Figure 3-38: Regulation Mode Screen – Channel 3

Entry	Description
CC/CV/CP	Sets the Regulation Mode as CC/CV/CP for selected channel. Supply switches between the CC (constant current), CV (constant voltage) and CP (constant power) modes based on the load conditions, without making the output to zero.
CC Mode	Sets the Regulation Mode as CC for selected channel. Supply regulates the output current at the set value. If the regulation of selected channel output current is not met due to change in load, it programs the respective channel output to zero after a programmable delay time.
CV Mode	Sets the selected channel Regulation Mode as CV. Supply regulates the output current at the set value. If the regulation of selected channel output current is not met due to change in load, it programs the respective channel output to zero after a programmable delay time.
CP Mode	Sets the selected channel Regulation Mode as CP. while in this mode, the supply will continually adjust the voltage and current levels of selected channel to attempt to maintain a constant power to the load.

To provide additional protection for the load, voltage, and current limits may be set while in the Constant-Power mode. If the unit cannot regulate to the Constant Power setting due to load conditions, it will regulate either at the voltage or current limit depending on the load demand.

(Note: Constant Power mode is intended primarily for loads with response times greater than approximately 10ms).

Delay Parameter field box allow user to set delay for CC, CV, and CP mode.

3.4.4.4 OUTPUT SENSE

Each channel output is provided with sense terminals to sense voltage at point of connection to the load. Line drop in the wires could be compensated by remote sense.

The Output Sense screen allows user to set the output voltage sense of each channel to either Remote or Local, refer to Figure 3-39. When Sense is selected as remote, Sense cables must be connected to rear panel of power the supply at pin S+ and S- of respected channel Output connector (refer Figure 2-9). User cannot change the Output Sense setting in output ON condition.

Front panel will display Remote Sense Fault under conditions:

1. If the remote sense is selected and the remote sense wiring is not done to the power supply unit.
2. If the remote sense is connected in the reverse polarity.
3. If the load cable drop exceeds 5% of the rated output voltage.

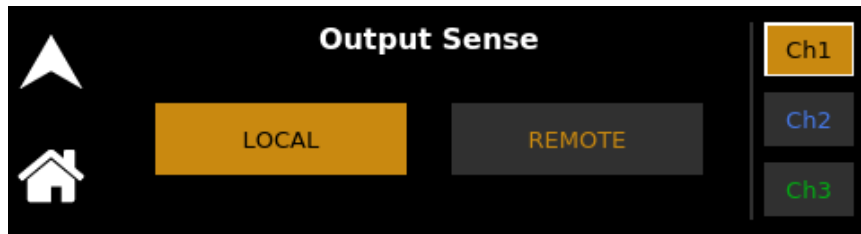

Figure 3-39: Output Sense Screen

Entry	Description
LOCAL	Sets supply to Local sense.
REMOTE	Sets supply to remote sense.

3.4.5 Measurements

The Measurements Menu will show the measurements of DC Output Voltage and Output Current in the floating-point value. In addition to that Output Status (ON/OFF), and regulation Mode (CV/CV/CP) are shown in the header of each channel, Refer Figure 3-40. Up- arrow and Home button will return to HOME MENU screen-1.

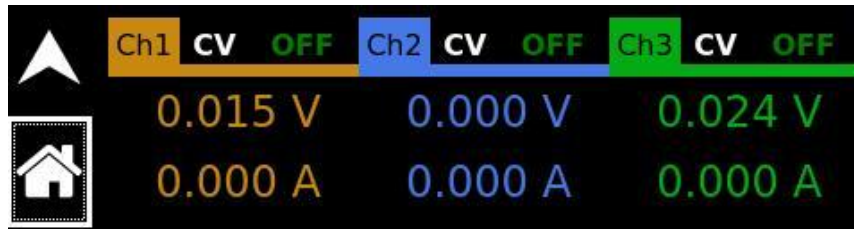

Figure 3-40: Measurements Screen Top Level Menu

3.4.6 Configuration Screen

This section demonstrates the configuration of power on- settings (PONS), set-up of User V/I Limits, Output Sense, Measurement Settings and Remote Inhibit Settings for individual channels.

The top-level menu of the Configuration screen is shown in Figure 3-41. Refer to Section 3.4.2.1 for navigating to Configuration Screen. If the supply is not provided with analog programming interface feature Current and Voltage Reference Mode menu would be inactive (greyed out) from the configuration menu screen; refer Figure 3-42. Reference mode would default Internal mode of operation. In that case power supply can only be controlled through front panel or remote communication interfaces.

Up-arrow and Home button will return to HOME MENU screen-2 (refer Figure 3-18).

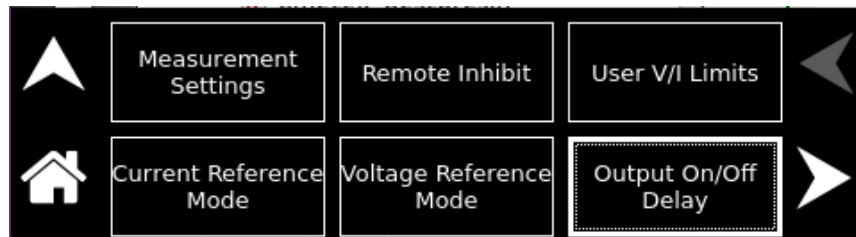

Figure 3-41: Configuration Menu screen 1

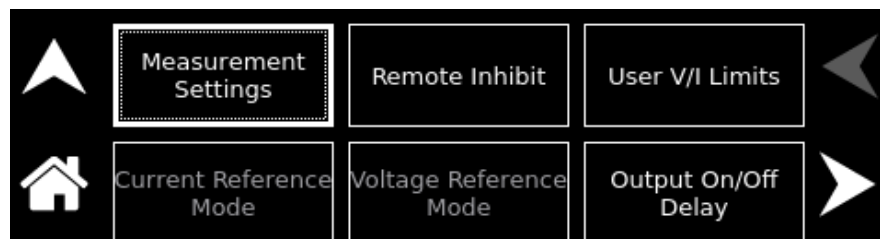

Figure 3-42: Configuration Menu screen 1 without Analog interface feature



Figure 3-43: Configuration Menu screen 2

The following menus are available in the Configuration Screen top-level menu:

- Measurement Settings
- Remote Inhibit Settings
- User V/I Limits
- Current Ref. Mode
- Voltage Ref. Mode
- Output On/Off Delay
- PONS

3.4.6.1 MEASUREMENTS SETTING

The Measurement Settings screen sets the number of readings for each channel to average together to reduce noise in the readback. Refer to Figure 3-44. Up-Arrow and Home button will return to HOME MENU screen 2; Refer Figure 3-18.

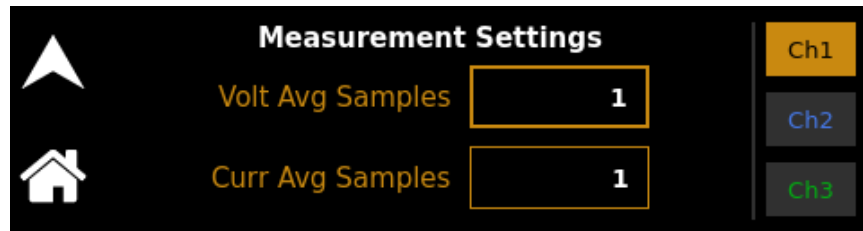

Figure 3-44: Measurement Settings Screen

The Measurement Settings screen has the following fields:

Entry	Description
Volt Avg Samples	Sets the number of voltage readings to the voltage readback. Allows to set a value between 1 to 5. The Default value is PONS Measurements settings.
Curr Avg Samples	Sets the number of current readings to average the current readback. Allows to set a value between 1 to 9. The Default value is PONS Measurements settings.

3.4.6.2 REMOTE INHIBIT

External user interface (26 pin connector) provides with remote inhibit inputs for each channel. A contact closure or direct short between remote inhibit terminal and return will allow the Output of power supply to be turned ON.

The external user interface connector (26 pin connector) is supplied with a mating connector which has the remote inhibit input output ON/OFF control signals for all the 3 channels connected (Pin-7 shorted to Pin-8 to enable channel-1, Pin-16 shorted to Pin-17 to enable channel-2, Pin-25 shorted to Pin-26 to enable channel-3) to allow the output to be enabled.

Remote inhibit can be configured in two modes (LIVE and LATCH), refer Figure 3-45. Mode can be selected from the front panel remote inhibit screen. From the factory default mode is LIVE. With this default factory setting (connected remote inhibit 26 pin mating connector installed and the remote inhibit mode being LIVE), the user can turn ON and OFF the power supply with the output switch.

User can remove the hardwired jumpers in the remote inhibit 26 pin female connector and wire to a contact closure as per their requirement. User would need to select the mode of remote inhibit using the front panel screen refer Figure 3-45, according to their requirement of fault clearance.

Figure 3-45 shows the front panel screen for remote inhibit with channel-1 selected, similarly user can select other channels and change the mode.

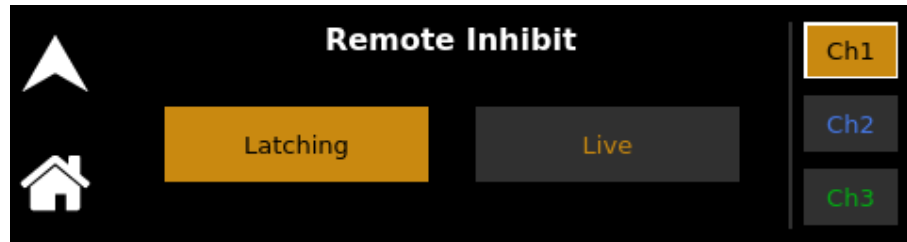

Figure 3-45: Remote Inhibit Screen channel 1

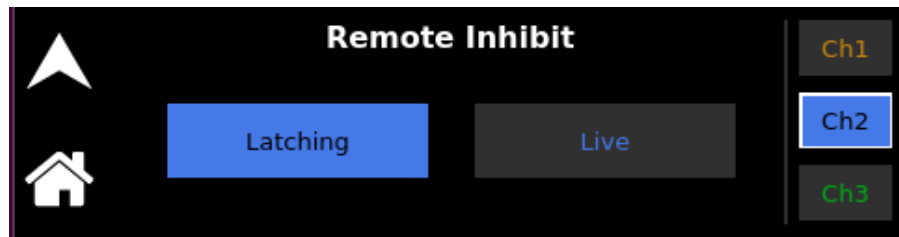

Figure 3-46: Remote Inhibit Screen channel 2

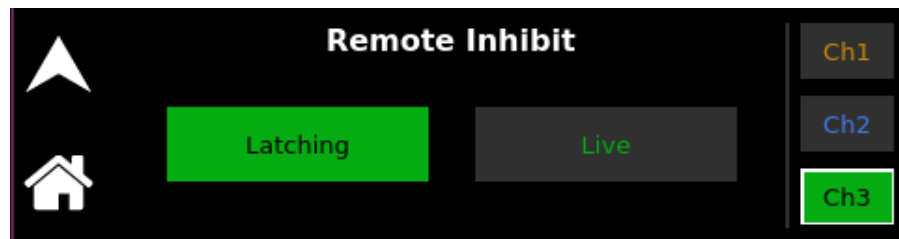

Figure 3-47: Remote Inhibit Screen channel 2

Entry	Description
Latching	<p>When the contact is opened between remote inhibit terminal and return, output is turned off and programmed to zero volts and the output latches in shutdown state.</p> <p>Having configure the channel remote inhibit input to Latching mode and contact opening in the remote inhibit input of channel creates remote inhibit fault in the front panel, user need to clear the fault to come out of the latched state. The fault needs to be cleared from the front panel fault status popup window or by issuing the SCPI Command <code>OUTP<n>:PROT:CLE</code> from the remote digital interface.</p> <p>Once the fault is cleared, power supply output is unlatched, upon the contact closure user can turn on the output of the power supply.</p>
Live	<p>When the contact is opened between remote inhibit terminal and return, output is turned off and programmed to zero volt.</p> <p>Having open contact between remote inhibit and return will shut down the output or will not allow the user to enable the output of the power supply and a contact between remote inhibit terminal and return will permits user to enable the output.</p> <p>In the live mode no fault is generated, and the output is not latched.</p>

3.4.6.3 USER V/I LIMITS

The User V/I Limits menu allows to set the soft limits for output voltage, current and power to each channel at power supply restart. Default values are PONS User V/I Limits configuration, refer to Figure 3-48.

Up-Arrow and Home button will return to HOME MENU screen 2; Refer Figure 3-18.

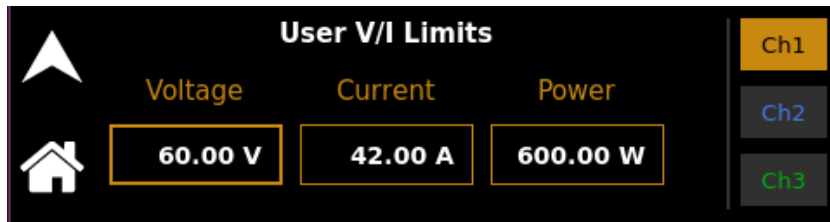

Figure 3-48: User V/I Limit Screen – Channel 1

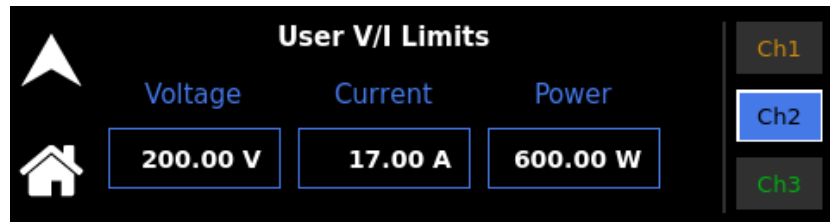

Figure 3-49: User V/I Limit Screen – Channel 2



Figure 3-50: User V/I Limit Screen – Channel 3

Entry	Description
Voltage	Sets the power-on default value of voltage user limit in Volts for each channel. The default is PONS User Voltage Limit.
Current	Sets the power-on default value of output current in Amperes for each channel. The default is PONS Current Limit.
Power	Sets power-on default value of the output power in watts(W) for each channel. The default is PONS User Power Limits.

3.4.6.4 CURRENT REF MODE

Sets the current reference mode to either INT (internal) or EXT (external) or INT+EXT (Internal + external) for the selected channels; refer Figure 3-51. The default reference mode is internal (INT). If EXT is selected as current reference mode for selected channel, respected channel voltage settings parameter field box would be disabled and displayed with text EXT; refer Figure 3-24.

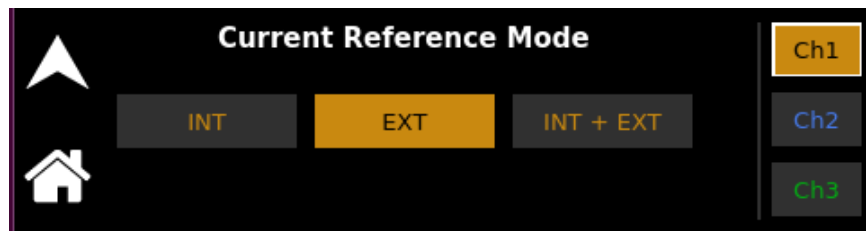

Figure 3-51: Current Reference Mode channel 1

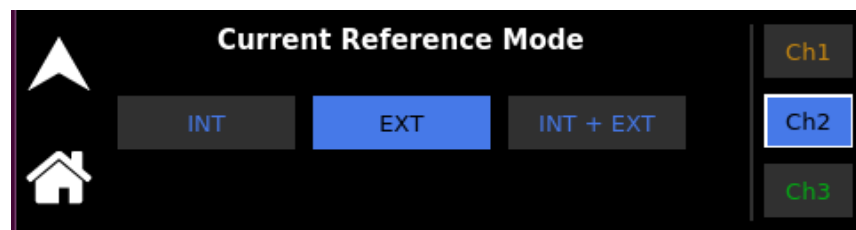

Figure 3-52: Current Reference Mode channel 2

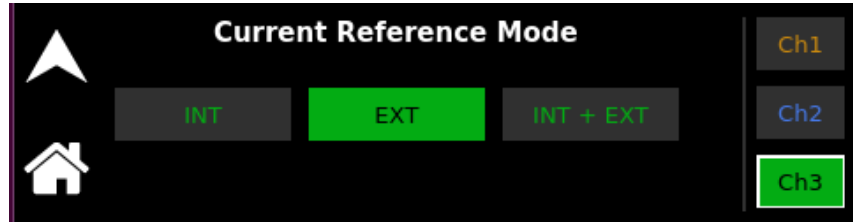

Figure 3-53: Current Reference Mode channel 3

Entry	Description
INT	Sets the Current Reference Mode into internal for selected channels. Allows user to program the output current through front panel and digital interfaces.
EXT	Sets the current Reference Mode into external for selected channels. Allows user to program the output current only through the analog programming interface.
INT + EXT	Sets the current Reference Mode into internal + external for selected channels. Allows user to program the output current through the analog programming interface, front panel, and digital interfaces.

3.4.6.5 VOLTAGE REF MODE

Sets the reference mode to either INT (internal) or EXT (external) or INT+EXT (Internal + external) for the selected channels; refer Figure 3-54. The default reference mode is internal (INT). If EXT is selected as voltage reference mode for selected channel, respected channel current settings parameter field box would be disabled and displayed with text EXT; refer Figure 3-23.

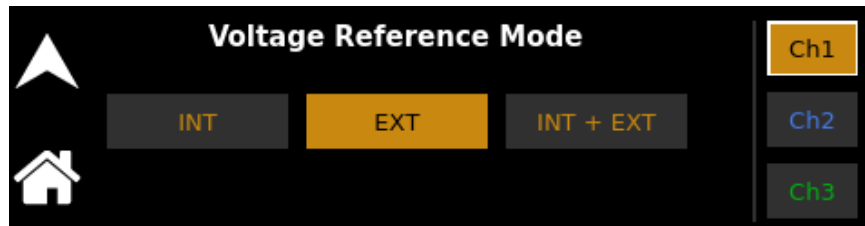

Figure 3-54: Voltage Ref Mode channel 1

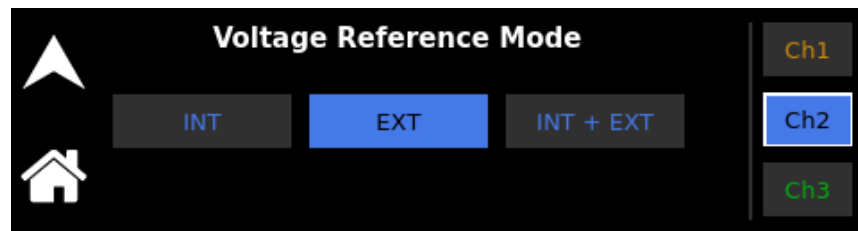

Figure 3-55: Voltage Ref Mode channel 2

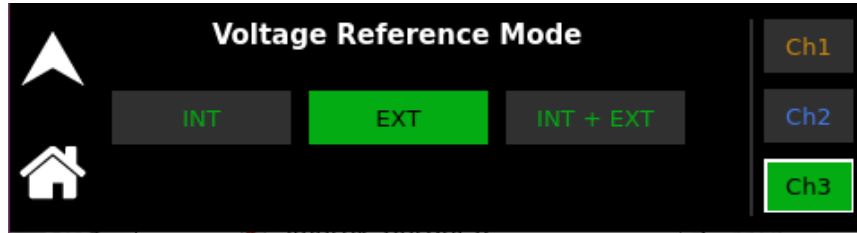

Figure 3-56: Voltage Ref Mode channel 3

Entry	Description
INT	Sets the Voltage Reference Mode into internal for selected channels. Allows user to program the output voltage through front panel and digital interfaces.
EXT	Sets the Voltage Reference Mode into external for selected channels. Allows user to program the output voltage only through the analog programming interface.
INT + EXT	Sets the Voltage Reference Mode into internal + external for selected channels. Allows user to program the output voltage through the analog programming interface, front panel, and digital interfaces.

3.4.6.6 OUTPUT ON/OFF DELAY

Output On/Off Delay screen permits to configure Output ON/OFF Delay settings. If Disable is selected the Output channels would become individual and user is restricted to configure the output On/Off delay settings from the OUTPUT ON/OFF DELAY Top Level Menu to turn On/Off the output of channels in a sequence. If Enable is selected, it allows user to configure the output On/Off delay settings from the OUTPUT ON/OFF DELAY Top Level Menu to turn On/Off the output of channels in a sequence.



Figure 3-57: Output On-Off Delay enable screen

Entry	Description
Enable	Sets the OUTPUT ON/OFF DELAY top level menu in enabled condition. Allows user to program the output ON/OFF delay.
Disable	Sets the OUTPUT ON/OFF DELAY top level menu in disabled condition. Restricts user to program the output ON/OFF delay.

3.4.6.7 POWER ON SETTINGS (PONS)

The PONS Menu allows user to set the Power-ON values which is programmed during next power cycle of unit. The top-level menu of PONS is shown in Figure 3-58. If the supply is not provided with analog programming feature following analog interface related menus are inactive (grayed out) from PONS menu screen: PONS – Current and Voltage Reference Mode menu, and PONS – Analog menu; refer Figure 3-60 and Figure 3-61.

Up-arrow will return to previous screen refer Figure 3-41, and Home button will return to HOME MENU screen-2 refer Figure 3-18.

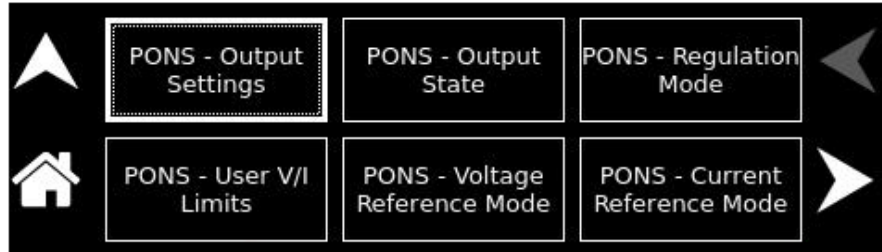

Figure 3-58: PONS Menu Screen-1

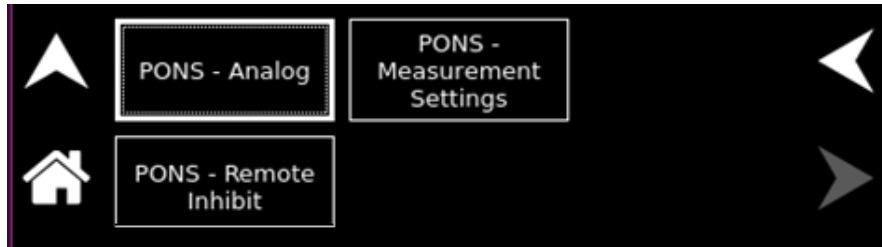

Figure 3-59: PONS Menu Screen-2

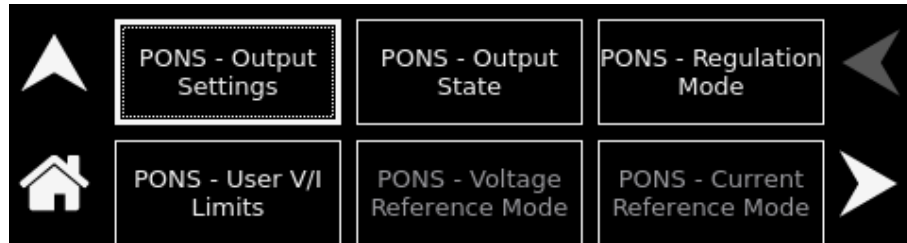

Figure 3-60: PONS Menu Screen-1 without Analog Interface feature

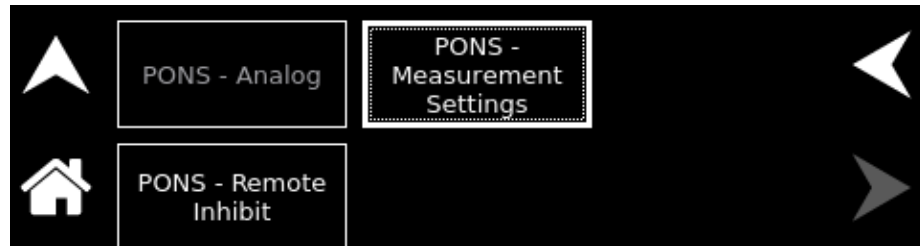

Figure 3-61: PONS Menu Screen-2 without Analog Interface feature

PONS menu contains following sub menu:

- PONS – Output Settings
- PONS – Output State
- PONS – Regulation Mode
- PONS – User V/I Limits
- PONS – Voltage Reference Mode
- PONS – Current Reference Mode
- PONS – Analog
- PONS – Measurement Settings
- PONS – Remote Inhibit

3.4.6.7.1 PONS - Output Settings Screen

The PONS Output Settings screen provides output related settings such as Voltage, Current and Over voltage Protection (OVP) for each channel during unit power-on. Settings set in below screen will be applied during next power cycle of unit.

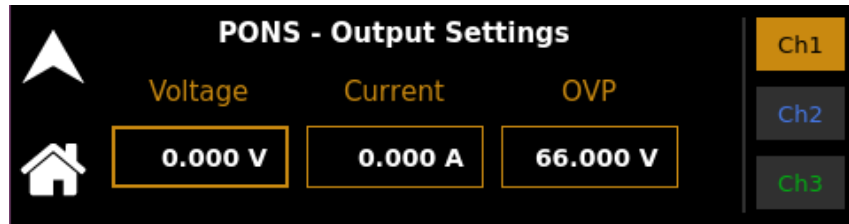

Figure 3-62: PONS - Output Settings Screen

The following choices are available in the PONS Output Settings screen. Functions that accept a numeric value require that the value be within the allowed range, otherwise, an error will be generated, and the value will not be accepted.

Entry	Description
Voltage	Programs the power-ON output voltage in Volts for each channel. The default value of each channel is 0.
Current	Programs the power-ON output current in Amperes for each channel. The default value for each channel is 0.
OVP	Programs the power-ON Overvoltage Protection (OVP) threshold for the output voltage. Exceeding the OVP threshold will result in shutdown of the output and the output voltage programmed to zero.

3.4.6.7.2 PONS - Output State Screen

PONS Output state screen provides the functionality to turn Output of each channel either ON or OFF at power-on of unit. If output is set to ON for any channel, then during next power cycle, warning screen will be displayed with abort button to turn off output

selected channel (refer Figure 3-15). If no action is taken by operator, then output will be turned ON for specific channel. Refer Figure 3-63.

Up-arrow will return to PONS menu screen; Refer Figure 3-58. Home button will return to HOME MENU screen 2; Refer Figure 3-18.

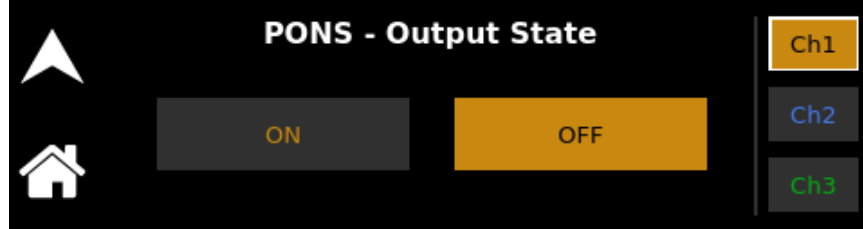

Figure 3-63: PONS - Output State Screen

Entry	Description
ON	Programs the power ON output state to ON for each channel.
OFF	Programs the power ON output state to OFF for each channel.

3.4.6.7.3 PONS - Regulation Mode Screen

PONS Regulation Mode screen provides functionality to set regulation mode of each channel during unit power-on. Up-arrow will return to PONS menu screen; Refer Figure 3-58. Home button will return to HOME MENU screen 2; Refer Figure 3-18.

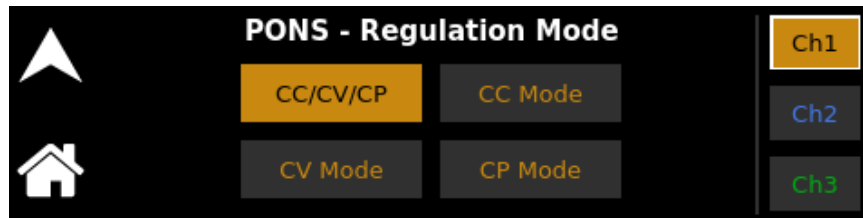

Figure 3-64: PONS - Regulation Mode Screen

Entry	Description
CC/CV/CP	Sets the power ON regulation mode into CC/CV/CP, Supply switches between the CC (constant current), CV (constant voltage) and CP (constant power) modes based on the load conditions, without making the output to zero.
CC Mode	Sets the power ON regulation mode into Constant Current Mode
CV Mode	Sets the power ON regulation mode into Constant Voltage Mode
CP Mode	Sets the power ON regulation mode into Constant Power Mode

3.4.6.7.4 PONS - User V/I Limits

The PONS User V/I Limits menu allows to set the soft-limits for output voltage, current and power of each channel at power-on of unit. Default value is full scale, refer to Figure 3-65.

Up-arrow will return to PONS menu screen; Refer Figure 3-58. Home button will return to HOME MENU screen 2; Refer Figure 3-18.

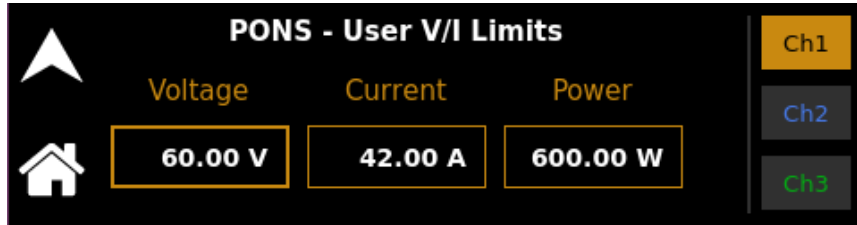

Figure 3-65: PONS - User V/I Limits Screen – Channel 1

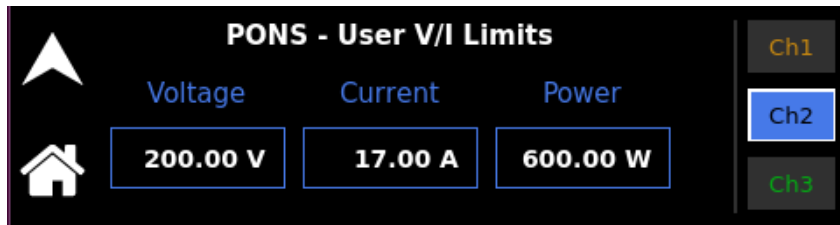

Figure 3-66: PONS - User V/I Limits Screen – Channel 2

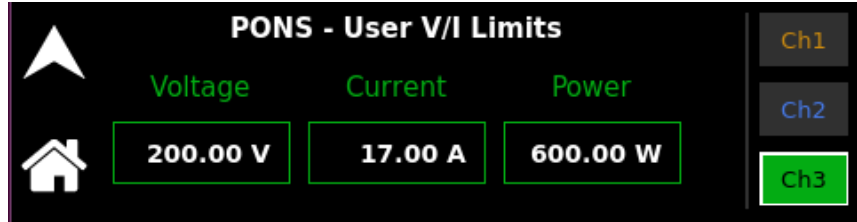

Figure 3-67: PONS - User V/I Limits Screen – Channel 3

Entry	Description
Voltage	Sets the power-on default value of voltage user limit in Volt for each channel. The default is full-scale of each channel.
Current	Sets the power-on default value of output current in Ampere for each channel. The default is full-scale for each channel.
Power	Sets power-on default value of the output power in watt (W) for each channel. The default is module power of each channel.

3.4.6.7.5 PONS – Voltage Ref Mode

Configures power-on Voltage Ref Mode either INT (internal) or EXT (external) or INT + EXT (internal + external) for selected channels. the default Mode is INT.



Figure 3-68: PONS – Voltage Ref Mode channel – 1

Entry	Description
INT	Configures power-on Voltage Ref Mode as internal for selected channels. INT (internal) is the factory default voltage ref Mode.
EXT	Configures power-on Voltage Ref Mode as external for selected channel.
INT + EXT	Configures power-on Voltage Ref Mode as internal + external for selected channel.

3.4.6.7.6 Pons – Current Ref Mode

Configures power – ON Analog Current Ref Mode either INT (internal) or EXT (external) or INT + EXT (internal + external) for selected channel, the default Mode is INT.

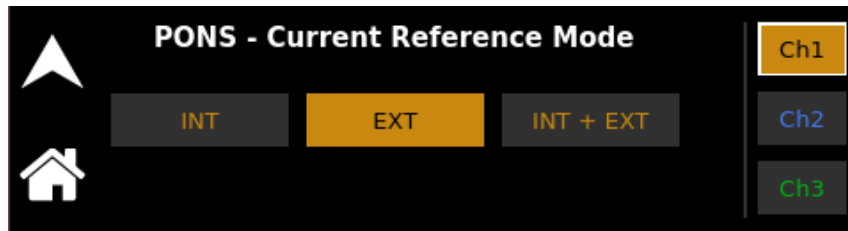

Figure 3-69: PONS – Current Ref Mode Channel – 1

Entry	Description
INT	Configures power-on Current Ref Mode as internal for selected channels. INT (internal) is the factory default voltage ref Mode.
EXT	Configures power-on Current Ref Mode as external for selected channels.
INT + EXT	Configures power-on Current Ref Mode as internal + external for selected channels.

3.4.6.7.7 PONS - Analog

Sets the Analog programming interface Configurations during UUT Power-ON, refer to Figure 3-70. Up-arrow will return to PONS menu screen; Refer Figure 3-58. Home button will return to HOME MENU screen 2; Refer Figure 3-18.

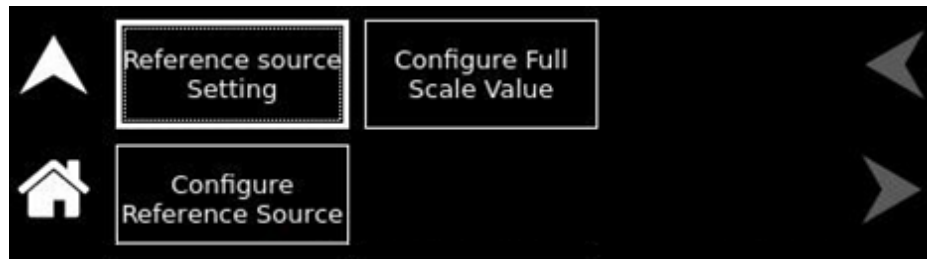

Figure 3-70: PONS - Analog Screen

PONS – Reference Source Settings:

Lists the power ON configuration settings of the Analog Programming interface for individual channels, which would be set in the Unit during next power cycle, Refer Figure 3-71.

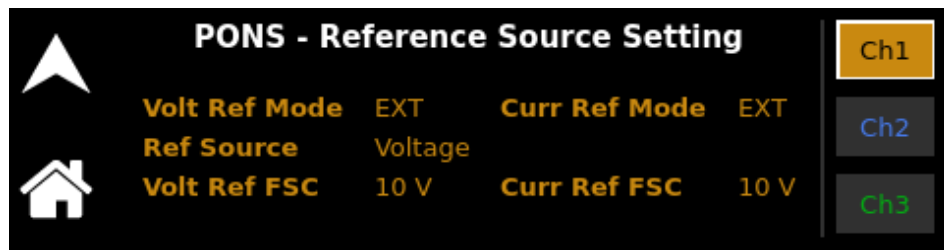

Figure 3-71: PONS - Reference Source Settings Screen channel-1

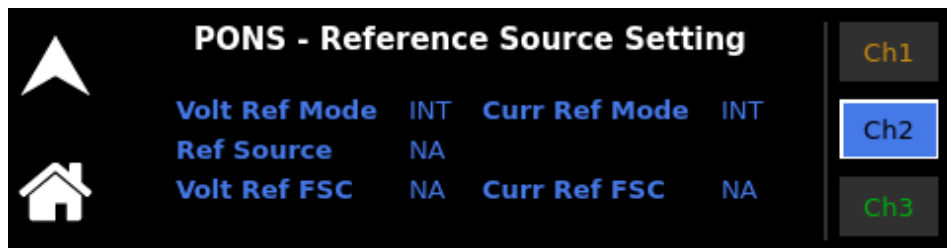

Figure 3-72: PONS - Reference Source Settings Screen channel-2

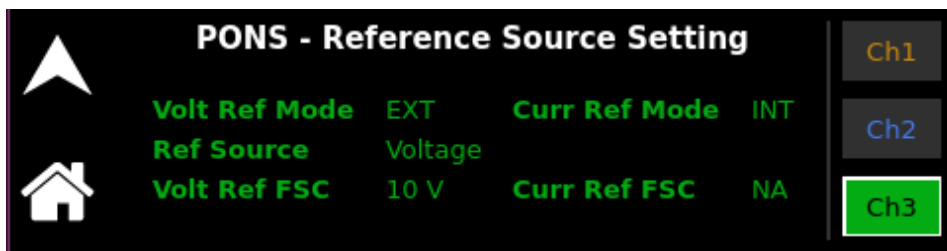

Figure 3-73: PONS - Reference Source Settings Screen channel-3

PONS - Configure Reference Source:

Sets the analog reference source to either Voltage or Resistive during supply power-ON for Selected channel, Refer Figure 3-74.

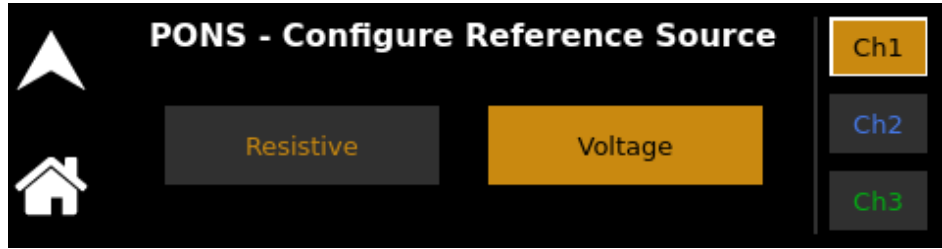

Figure 3-74: PONS – Configure Reference Source channel - 1

Entry	Description
Voltage	Configures power-on analog programming reference source as voltage source for selected channel. Voltage is the factory default reference source. For a given channel reference source would be same for both output voltage and output current analog programming.
Resistive	Configures power-on analog programming reference source as resistance for selected channel. For a given channel reference source would be same for both output voltage and output current analog programming.

PONS - Configure Full Scale Value:

Sets the analog programming Full Scale Value (FSC) of Analog Voltage and Current programming for Selected channels at power-ON, Refer Figure 3-75 and Figure 3-76.

If the PONS -analog ref source is selected resistive the unit of FSC would be kΩ (Kilo Ohm); refer Figure 3-76, and if it is voltage the unit of FSC will become V (volt); refer Figure 3-75.

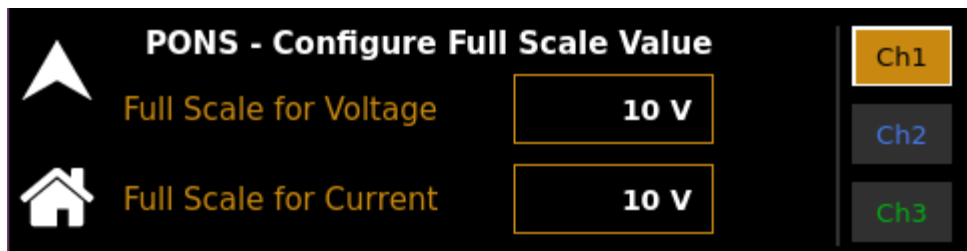

Figure 3-75: PONS – Configure Full Scale Value Channel-1

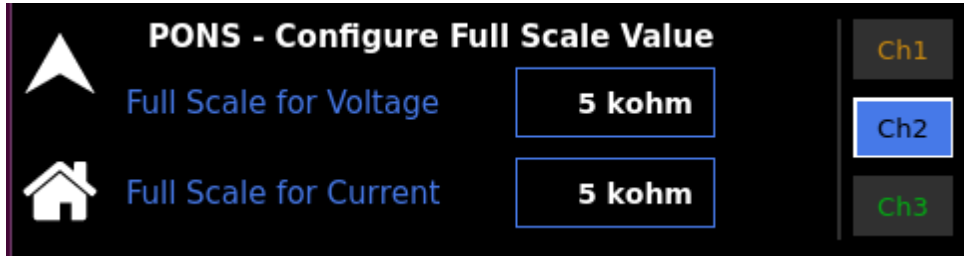

Figure 3-76: PONS – Configure Full Scale Value Channel-2

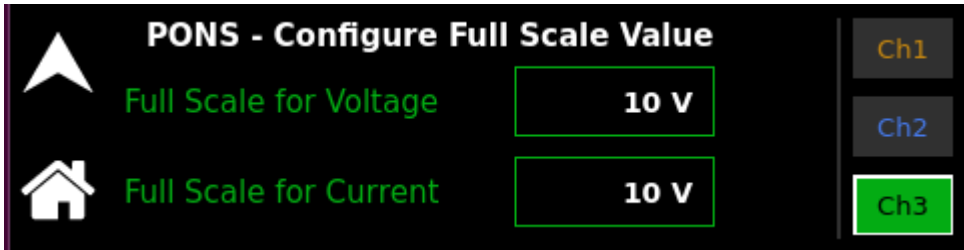

Figure 3-77: PONS – Configure Full Scale Value Channel-3

Entry	Description
Full Scale for Voltage:	To Set the power-on FSC value of analog voltage program for Selected Channels, default FSC is 10V for Voltage reference source and 10kΩ for Resistive reference source. FSC (Full scale) value can be programmed from 5V to 10V for voltage source as reference and 5kΩ to 10kΩ for resistive reference source.
Full Scale for Current:	To Set power-on FSC value of analog current program for Selected Channels, default FSC is 10V for Voltage reference source and 10kΩ for Resistive reference source. FSC (Full scale) value can be programmed from 5V to 10V for voltage source as reference and 5kΩ to 10kΩ for resistive reference source.

3.4.6.7.8 PONS - Measurements Setting

The PONS Measurement Settings screen sets the number of readings to be used for averaging at power-on for voltage and current measurements. Refer to Figure 3-78.

Up-arrow will return to PONS menu screen; Refer Figure 3-58. Home button will return to HOME MENU screen 2; Refer Figure 3-18.

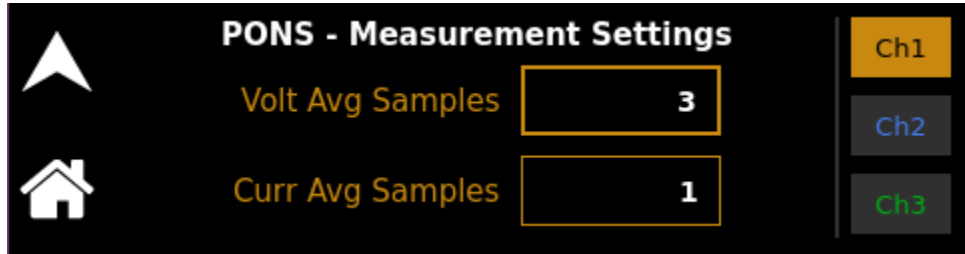

Figure 3-78: PONS - Measurement Settings Screen

The Measurement Settings screen has the following fields:

Entry	Description
Volt Avg Samples	<p>Sets the number of voltage readings to average in the voltage readback during Unit power-on.</p> <p>Allows to set a value between 1 to 5. The value of 1 (factory default) provides the fastest response time in the readings, but less rejection of noise.</p>
Curr Avg Samples	<p>Sets the number of current readings to average in the current readback during the power-on.</p> <p>Allows to set a value between 1 to 9. The value of 1 (factory default) provides the fastest response time in the readings, but less rejection of noise.</p>

3.4.6.7.9 PONS – Remote Inhibit

Configures the power-ON remote inhibit mode either Latching or Live Mode for selected channel; refer Figure 3-79. Refer to section 3.4.6.2. The remote inhibit modes are explained in detail.

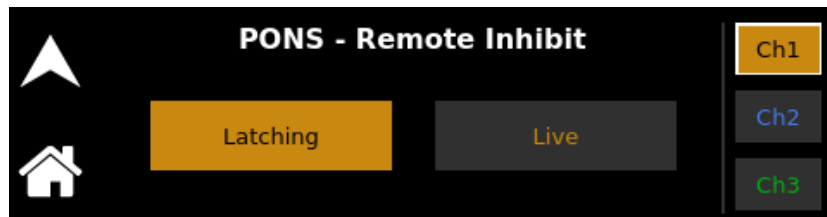

Figure 3-79: PONS – Remote Inhibit channel 1

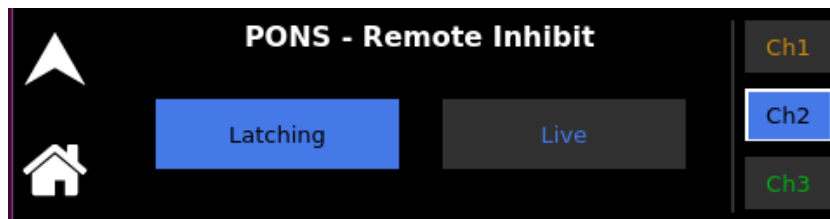

Figure 3-80: PONS – Remote Inhibit channel 2

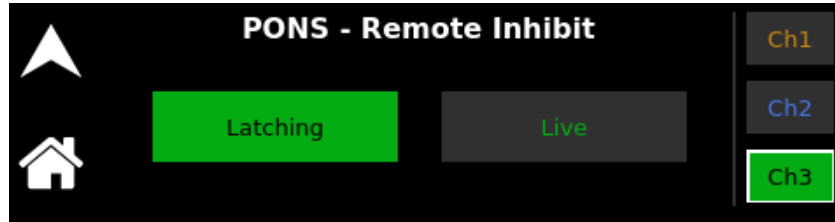

Figure 3-81: PONS – Remote Inhibit channel 3

Entry	Description
Latching	Configures power-on Remote Inhibit Mode as Latching for selected channels.
Live	Configures power-on Remote Inhibit Mode as Live for selected channels. Live is the factory default Remote Inhibit Mode.

3.4.7 Ramp

The Ramp Screen provides the functionality to create voltage and current Ramp in each channel individually. The top-level menu of the Ramp screen is shown in refer to Figure 3-82. Up-Arrow and Home button will return to HOME MENU screen 2; Refer Figure 3-18.



Figure 3-82: Ramp Menu Screen

The following menus are available in the Ramp top-level menu:

- Voltage Ramp
- Current Ramp

3.4.7.1 VOLTAGE RAMP

The front panel Voltage Ramp screen allows to configure and execute voltage ramp only for a selected channel at a time. The Voltage Ramp menu allows the selection of parameters such as Volt (initial volt), To Volt (end volt), Curr (Limit Current), Time and Trigger (software trigger (Trig. SW) or hardware trigger (Trig. HW)), refer to Figure 3-83.

Pressing Exit button voltage ramp would return to Ramp Menu screen; Refer Figure 3-82.

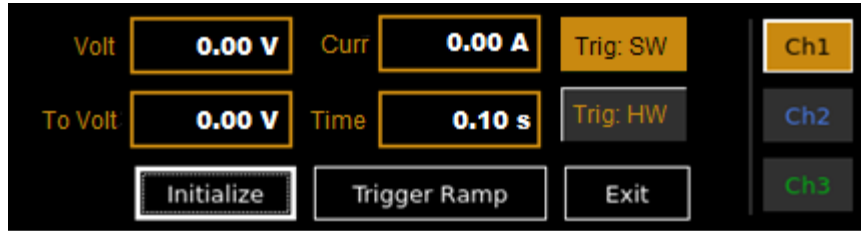

Figure 3-83: Voltage Ramp Screen

The Voltage Ramp menu has the following fields:

Entry	Description
Volt	Sets the start voltage for the ramp.
To Volt	Sets the end voltage for the ramp.
Curr	Sets the Current limit for the ramp.
Time	Sets the time in seconds to reach from start volt to end volt. Time can be programmed from 0.10s to 9999s.
Trigger	Sets the trigger mode for the ramp. In SW (Software) trigger mode, the ramp is generated as soon as the Trigger Ramp button is pressed. In HW (Hardware) trigger mode, the ramp will be generated when an active high pulse of 10ms is applied on corresponding channel trigger pins in the DB26 external interface connector; Refer Table 4-1 for PIN details. Pin-1 (TRIG1_IN) and Pin-8 (RTN) to trigger ramp for channel 1, Pin-10 (TRIG2_IN) and Pin-17 (RTN) to trigger ramp for channel 2, And Pin-19 (TRIG3_IN) and pin-26 (RTN) to trigger ramp for channel 3.
Initialize	Initializes the set Ramp parameters. Refer to Figure 3-84. Press OK to return.

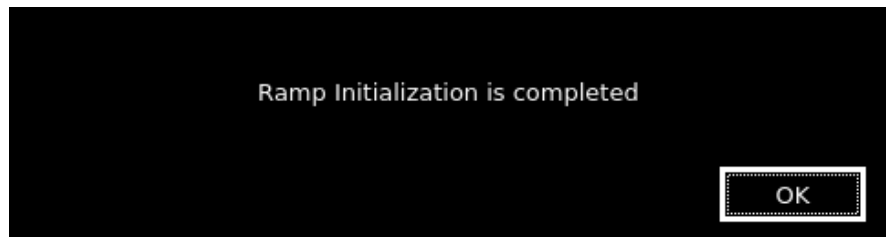

Figure 3-84: Ramp-Screen (Initialization)

Trigger Ramp Generates the ramp in **SW** trigger mode. **Trigger Ramp** button will only be enabled after **Initialize** button is pressed, Refer to Figure 3-85:.

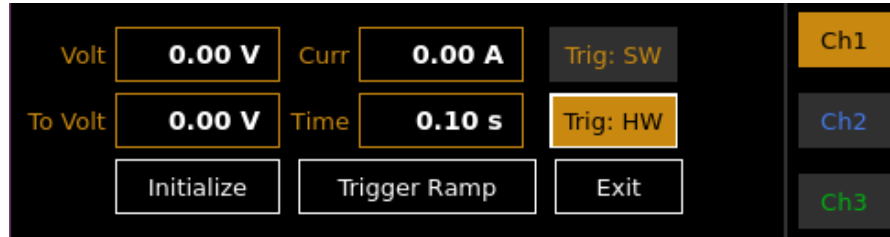

Figure 3-85: Voltage Ramp-Screen (SW Trigger)

Waiting for Trig

This field is displayed after Initialize button is pressed in HW trigger Mode, refer to Figure 3-86:

This shows that the supply is waiting for an active high pulse of 10ms on the DB26 connector to generate the Voltage Ramp; Refer Table 4-1 for PIN details.

Active high pulse on Pin-1 (TRIG1_IN) and Pin-8 (RTN) will trigger ramp for channel 1,

Active high pulse on Pin-10 (TRIG2_IN) and Pin-17 (RTN) will trigger ramp on channel 2,

And active high pulse on Pin-19 (TRIG3_IN) and Pin-26 (RTN) to trigger ramp on channel 3.

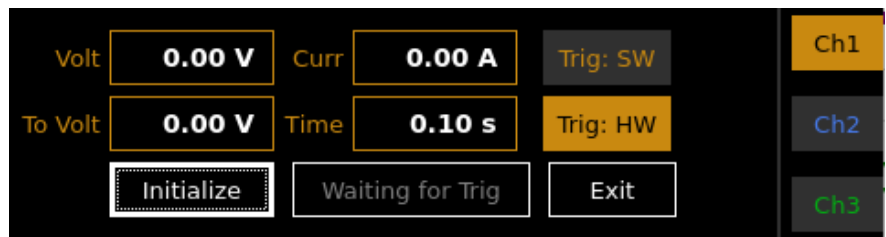

Figure 3-86: Voltage Ramp-Screen (HW Trigger)

Abort

Using **SW** trigger mode, when **Trigger Ramp** button is pressed, **Ramp Screen** Proceed to **Abort** Screen. In **HW** trigger mode, when external trigger is received, **Voltage Ramp screen** will change to **Abort** Screen, refer to Figure 3-87. Pressing the **Abort** button aborts the ramp and returns to **Ramp** screen. Abort Screen will contain following details:

Voltage Ramp displays as Engaged indicating ramp is in progress, Ramp running time, measurement of voltage and current. Running (Timer) format is represented as hh:mm:ss.

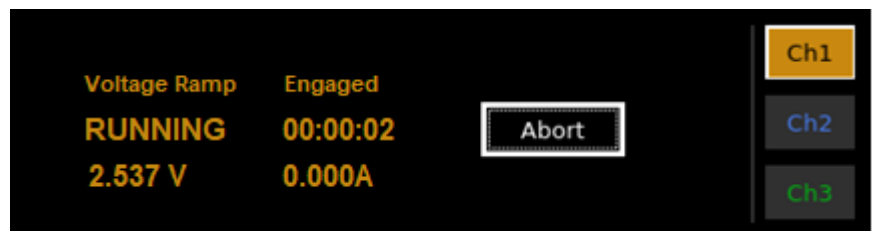

Figure 3-87: Voltage Ramp-Screen (Abort)

Exit Exits the Voltage Ramp sub menu and return to Ramp Menu, refer to Figure 3-82.

Example 1: Creating a Voltage ramp using Software Trigger mode

- Select Channel
- Set the **Volt** to 25V
- Set the **To Volt** to 50V
- Set the **Curr** to 20A
- Set the **Time** to 10s
- Select the Trigger mode as **SW** (software)
- Click on **Initialize**.
- Click on **Trigger Ramp**
- Observe that **Ramp Screen** will change to **Abort** Screen; refer Figure 3-87.
- Observe the voltage ramp signal using oscilloscope.
- Clicking on the **Abort** button will abort the ramp and return to Voltage Ramp screen; refer Figure 3-83.
- Clicking on the **Exit** button will exit the Voltage Ramp screen; and return to Ramp Menu screen refer Figure 3-82.

Example 2: Creating a Voltage ramp using Hardware Trigger mode

- Select Channel
- Set the **Volt** to 25V
- Set the **To Volt** to 50V
- Set the **Curr** to 20A
- Set the **Time** to 10s
- Select the Trigger mode as **HW** (Hardware)
- Click on **Initialize**.
- Observe that **Trigger Ramp** button will change to **Waiting for Trig**; refer Figure 3-86:.
- Give an external trigger i.e., an active high pulse of 10ms on the DB26 connector pin-1 (TRIG1_IN) and pin-8 (RTN) if channel 1 selected, pin-10 (TRIG2_IN) and pin-17 (RTN) if channel 2 is selected, and pin-19 (TRIG3_IN) and pin-26 (RTN) if channel 3 selected to generate the Voltage Ramp for Selected channel.
- Observe that **Ramp** Screen will change to **Abort** Screen; refer Figure 3-87.
- Observe the voltage ramp signal using oscilloscope Clicking on the **Abort** button will abort the ramp and returns to Ramp Screen; refer Figure 3-83.
- Clicking on the **Exit** button will exit the Voltage Ramp screen and return to Ramp Menu screen; refer Figure 3-82.

3.4.7.2 CURRENT RAMP

The front panel Current Ramp screen allows to configure and execute Current ramp only for a selected channel at a time. The Current Ramp menu allows the selection of parameters such as Curr (initial current), To Curr (end current), Volt (voltage limit), Time, and Trigger (software trigger (Trig. SW) or hardware trigger (Trig. HW)), refer to Figure 3-88.

Pressing Exit button would return to Ramp Menu screen 2; Refer Figure 3-82.

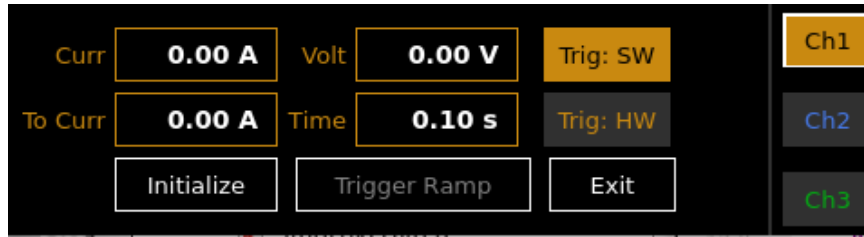

Figure 3-88: Current Ramp Screen

The Current Ramp menu has the following fields:

Entry	Description
Curr	Sets the start current for the ramp.
To Curr	Sets the end current for the ramp.
Volt	Sets the volt limit for the ramp.
Time	Sets the time in seconds to reach from start current to end current.
Trigger	Sets the trigger mode for the ramp. In SW (Software) trigger mode, the ramp is generated as soon as the Trigger Ramp button is pressed. In HW (Hardware) trigger mode, the ramp will be generated when an active high pulse of 10ms is applied on the DB26 connector respected channel TRIG_IN pin; Refer Table 4-1 for PIN details. Pin-1 (TRIG1_IN) and Pin-8 (RTN) to trigger ramp for channel 1, Pin-10 (TRIG2_IN) and Pin-17 (RTN) to trigger ramp for channel 2, And Pin-19 (TRIG3_IN) and pin-26 (RTN) to trigger ramp for channel 3.
Initialize	Initializes the set Ramp parameters. Refer to Figure 3-89. Press OK to return.

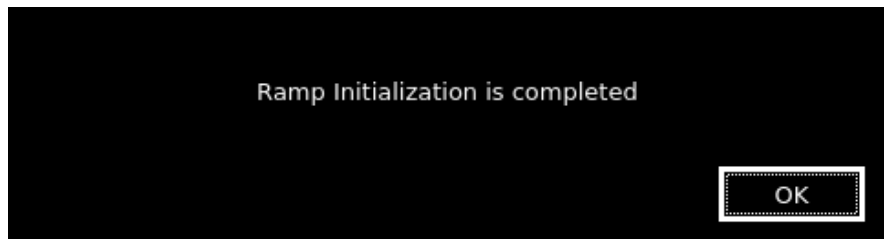

Figure 3-89: Ramp-Screen (Initialization)

Trigger Ramp	Generates the ramp in SW trigger mode. This will only be enabled after Initialize button is pressed, refer to Figure 3-90-:.
---------------------	--

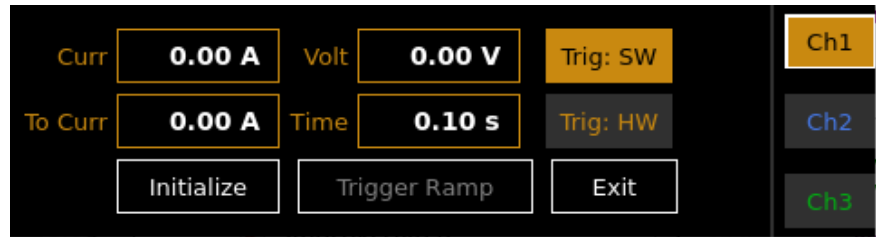

Figure 3-90:- Current Ramp-Screen (SW Trigger)

Waiting for Trig

This field is displayed after **Initialize** button is pressed in **HW** trigger Mode, refer to Figure 3-91:.

This shows that the supply is waiting for an active high pulse of 10ms on the DB26 connector to generate the Current Ramp each channel individually. Refer Table 4-1 for PIN details.

Active high pulse on Pin-1 (TRIG1_IN) and Pin-8 (RTN) will trigger ramp for channel 1,

Active high pulse on Pin-10 (TRIG2_IN) and Pin-17 (RTN) will trigger ramp on channel 2,

And active high pulse on Pin-19 (TRIG3_IN) and Pin-26 (RTN) to trigger ramp on channel 3.

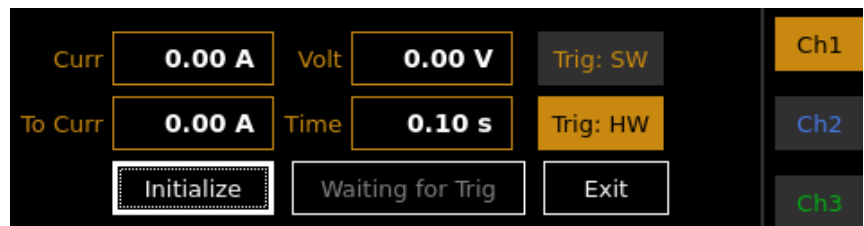

Figure 3-91: Current Ramp-Screen (HW Trigger)

Abort

In **SW** trigger mode, when **Trigger Ramp** button is pressed, **Ramp** Screen proceed to **Abort** Screen.

In **HW** trigger mode, when external trigger is received, **Ramp** Screen will Proceed to **Abort** Screen, refer to Figure 3-92. Pressing the **Abort** button aborts the ramp and returns to Ramp screen. Current Ramp displays as Engaged indicating ramp is in progress, Ramp running time, measurement of voltage and current. Running (Timer) format is represented as hh:mm:ss.

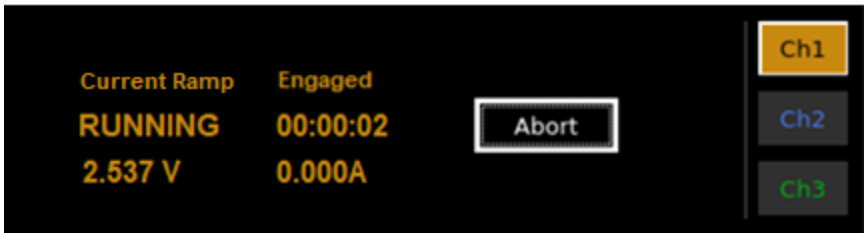

Figure 3-92: Current Ramp-Screen (Abort)

Exit Exits the Current Ramp screen and return to Ramp Menu Screen, refer to Figure 3-82.

Example 1: Creating a Current ramp using Software Trigger mode

- Select channel
- Set the **Curr** to 10A
- Set the **To Curr** to 30A
- Set the **Volt** to 25V
- Set the **Time** to 10s
- Connect an appropriate load to the supply
- Select the Trigger mode as **SW** (software)
- Click on **Initialize**
- Click on **Trigger Ramp**
- Observe that **Ramp** Screen Proceed to **Abort** Screen; refer Figure 3-92.
- Observe the current ramp signal using oscilloscope
- Clicking on the **Abort** button will abort the ramp and returns to Current Ramp screen; refer Figure 3-88.
- Clicking on the **Exit** button will exit the Ramp Menu screen; refer Figure 3-82.

Example 2: Creating a Current ramp using Hardware Trigger mode

- Select **channel**
- Set the **Curr** to 10A
- Set the **To Curr** to 30A
- Set the **Volt** to 25V
- Set the **Time** to 10s
- Connect an appropriate load to the supply
- Select the Trigger mode as **HW** (Hardware)
- Click on **Initialize**
- Observe that **Trigger Ramp** button will change to **Waiting for Trig**; refer Figure 3-91:.
- Give an external trigger i.e., an active high pulse of 10ms on the DB26 connector pin-1 (TRIG1_IN) and pin-8 (RTN) if channel 1 selected, pin-10 (TRIG2_IN) and pin-17 (RTN) if channel 2 is selected, and pin-19 (TRIG3_IN) and pin-26 (RTN) if channel 3 selected to generate the Current Ramp for Selected channel.
- Observe that **Ramp** screen proceed to **Abort** Screen.
- Observe the current ramp signal using oscilloscope.

- Clicking on the **Abort** button will abort the ramp and returns to Current Ramp screen; refer Figure 3-88.
- Clicking on the **Exit** button will exit the Ramp Menu screen; refer Figure 3-82.

3.4.8 Output On/Off Delay

OUTPUT ON/OFF DELAY menu allows to configure the output to turn ON or to turn OFF the output in a sequence with respect to one of the reference channel with a programmable delay time. The minimum programmable delay is 30 ms with an accuracy of +/- 2 ms.

The Output ON Delay has the following sub menu. Refer Figure 3-93

- Settings
- Configure Output Condition
- Configure Reference Channel
- Configure Delay

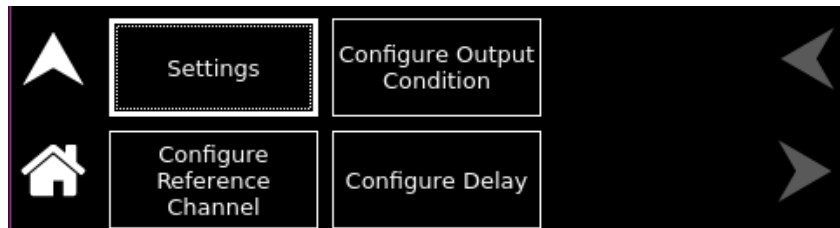

Figure 3-93: Output ON/OFF delay Menu screen

3.4.8.1 SETTINGS

Lists the configuration settings of Output ON/OFF Delay configurations of the power supply. Refer Figure 3-94.

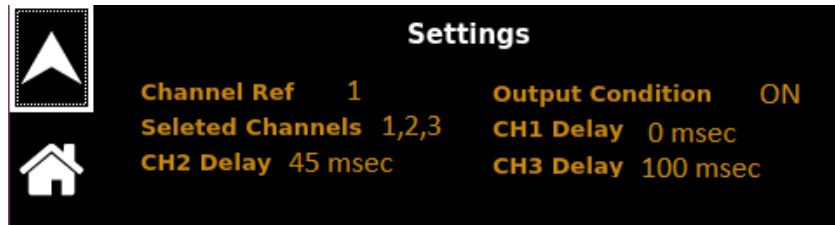

Figure 3-94: Output On/Off Settings screen

3.4.8.2 CONFIGURE OUTPUT CONDITION

Configure Output Condition screen allows the supply to turn ON or to turn OFF the Output of selected channels in a sequence with given delay time and channels could be selected from the Configure Reference Channel Screen (refer Figure 3-96). Button ON in the Figure 3-95 enables the output of selected channels in sequence manner

with configured delay and button OFF disables the output of selected channels as per the delay configured (refer Figure 3-100).

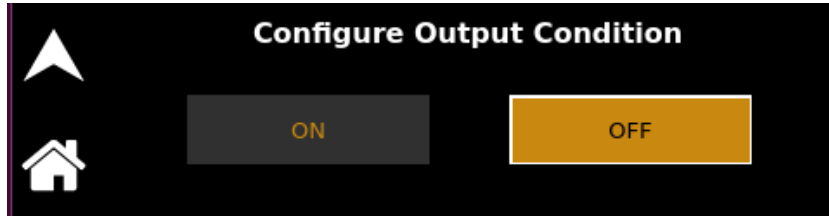

Figure 3-95: Configure Output Condition screen

Entry	Description
ON	Allows the selected channels to turn ON output in a sequence with programable delay.
OFF	Allows the selected channels to turn OFF output in a sequence with programable delay.

3.4.8.3 CONFIGURE REFERENCE CHANNEL

CH Ref (channel reference) sets the supply to turn ON or to turn OFF the output of selected channel as starting sequence; refer to Figure 3-96, as per the CH Ref respective channel delay settings field would be masked; refer to Figure 3-100.

Select Channels sets the supply to turn ON or to turn OFF the output of selected channels in the sequence; refer to Figure 3-96, Minimum of 2 channels required to be selected from the Select Channels field or else a warning screen will be displayed; refer Figure 3-97. Selected reference channel must be selected from the Select Channels field or else a warning screen will be displayed; refer Figure 3-98. Respective unselected channel delay settings field would be masked; refer to Figure 3-100.

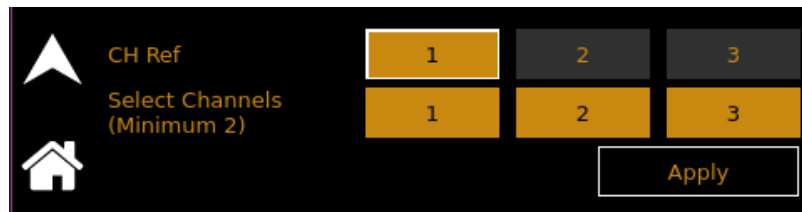

Figure 3-96: Configure Reference Channel screen

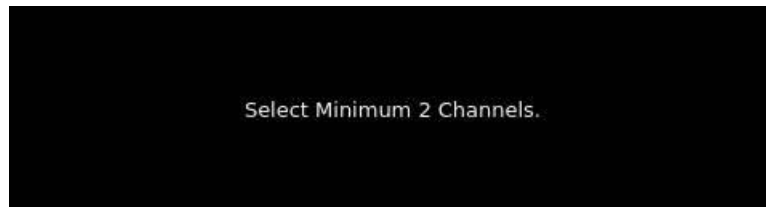

Figure 3-97: Warning screen 1

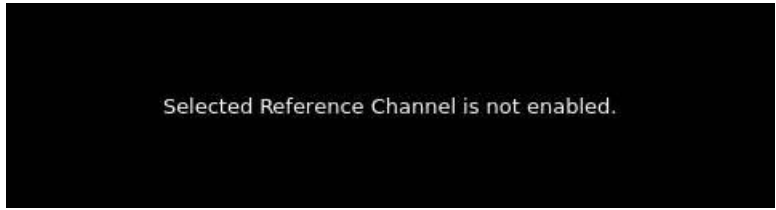

Figure 3-98: Warning screen 2

Entry	Description
CH Ref	Allows to select Reference channel to be turned ON initially. Button 1 selects channel 1 as reference channel, button 2 selects channel 2 as reference channel and button 3 selects channel 3 as reference channel. Any one of the channels could be selected as reference channel.
Select Channel	Allows to select the output channels to be turned ON in a sequence, button 1 will Select Channel 1 output, button 2 will Select Channel 2 output and button 3 will Select Channel 3. Minimum two channel must be selected among the three channels.
Apply	Applies the Configured CH Ref and Select Channels settings to the supply.

3.4.8.4 CONFIGURE DELAY

Configure Delay screen allows the user to configure the delay time required to enable or disable the output of each channel. Refer Figure 3-100.

The minimum programmable delay is 30ms and maximum programmable delay is 999000ms.

Example:

CH Ref is 1, CH2 delay = 40ms and CH3 delay = 100ms

if the Output state is selected ON from the Output Settings screen (refer Figure 3-94),

Channel 1 output will get turned ON initially without any delay,

Channel 2 output will get turned ON with given 40ms delay time,

Channel 3 output will get turned ON with given 100ms delay time; Refer Figure 3-99.

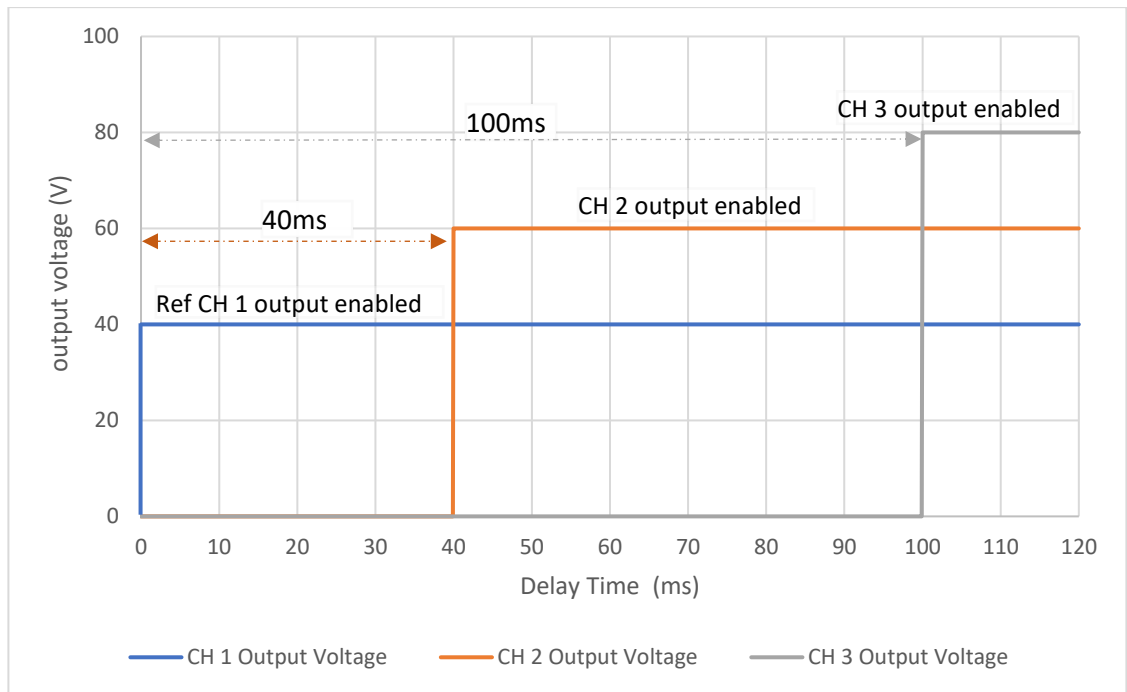

Figure 3-99: Output ON Delay graph

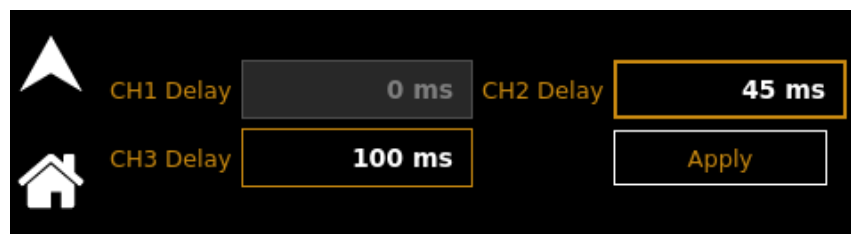

Figure 3-100: Delay settings screen

Entry	Description
CH1 Delay	Sets the channel 1 output delay time.
CH2 Delay	Sets the channel 2 output delay time.
CH3 Delay	Sets the channel 3 output delay time.
Apply Now	Applies configured settings to the power supply.

In order to initiate sequence to turn ON or to turn OFF the output of supply for selected channels. User should Enable the output On/Off delay from the CONFIGURATION menu (refer Figure 3-57) and configure the Output ON or to turn OFF Delay settings such as output condition, reference channel and configure delay. Upon user should select respective reference channel in the dashboard screen and should press Output button from the front panel.

Steps to program Output ON/OFF Delay:

- Navigate to CONFIGURATION Menu and to the Output On/Off Delay sub menu and select Enable; refer Figure 3-57.
- Navigate to OUTPUT ON/OFF DELAY Top Level Menu to Configure Delay, Reference Channel and Output condition.
- Navigate to Configure Output Condition sub menu and select ON or OFF; refer Figure 3-95.
- Navigate to Configure Reference Channel sub menu,
- Set the reference channel and select channels to turned ON or OFF in the sequence; refer Figure 3-96.
- Navigate to Configure Delay sub menu and program the delay settings; refer Figure 3-100.
- Navigate to Dashboard screen and Select respective reference channel; refer Figure 3-20.
- Press Output button from the front panel; refer Figure 3-1.

3.4.9 Control Interface Screen

The power supply provided with digital communication interface such as RS232, LAN, and USB as default. Digital communication interface Analog and GPIB will be provided with the supply only if the user orders for supply with communication interface.

Manufacturer provided communication interface with the power supply would be active and others would be inactive (grayed out) in the front panel screen refer below the Control interface screens. Refer Figure 3-102 and Figure 3-103.

The Control Interface screen provides the ability to configure the power source for remote control through the data communications interfaces. From control Interface screen, user can also configure Analog Programming feature to program the power supply parameters from external sources such as voltage and Resistance. The top-level menu of the Control Interface screen is shown Figure 3-101. Refer to Section 3.4.2.1 for navigating to Control Interface Screen.

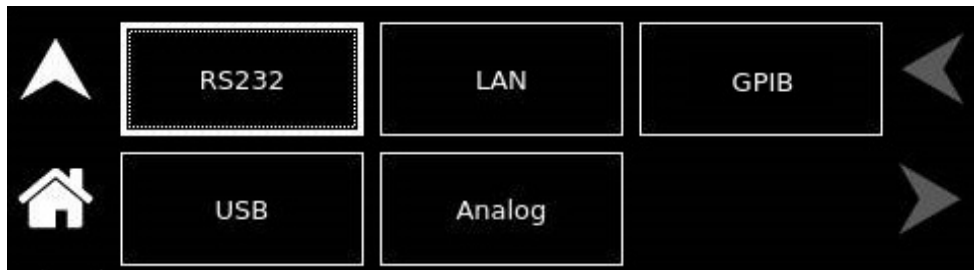

Figure 3-101: Control Interface Menu Screen

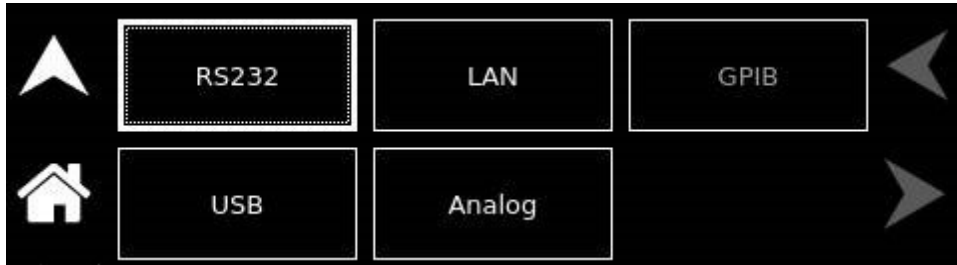

Figure 3-102: Control Interface Menu Screen with GPIB disabled

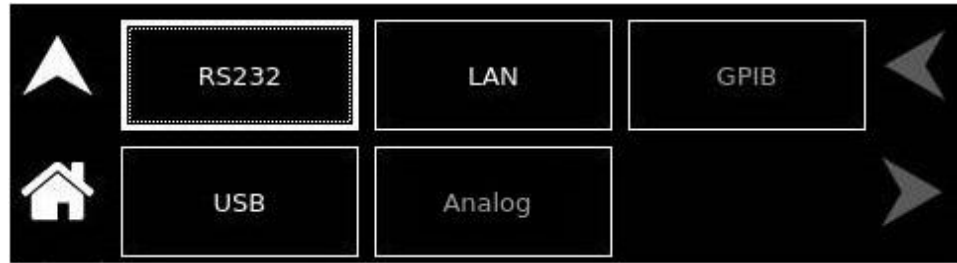

Figure 3-103: Control Interface Menu Screen with Analog disabled

The following menus are available in the Control Interface Screen top-level menu: RS232, LAN, Analog, USB and GPIB.

3.4.9.1 RS232

The following menus are available in the RS232 menu: RS232 Settings and Configure RS232.

Entry	Description
RS232 Settings	Lists the configured Baud Rate, Stop Bits, Bits and Parity for the RS232 digital interface, refer to Figure 3-104 and Figure 3-105.

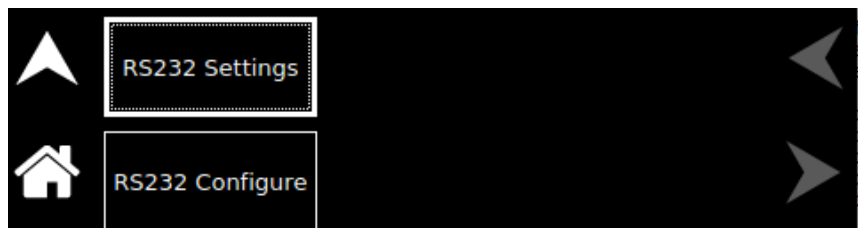

Figure 3-104: RS232 Home Screen



Figure 3-105: RS232 Setting Screen

RS232 Configure Use to configure the USB baud rate for the RS232 digital interface, refer to Figure 3-106.

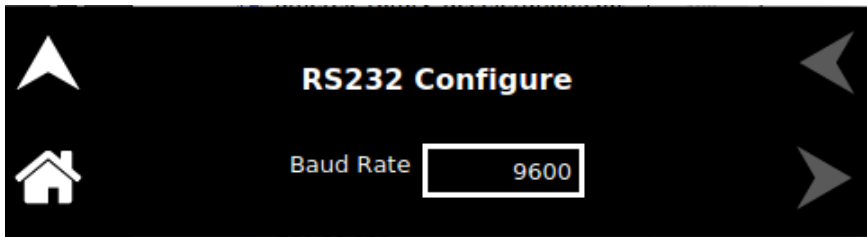

Figure 3-106: RS232 Configure Screen

3.4.9.2 LAN

Configures the LAN (LXI Ethernet) communications interface. The following menus are available in the LAN menu screen, refer to Figure 3-107.

- LAN Settings
- Configure LAN

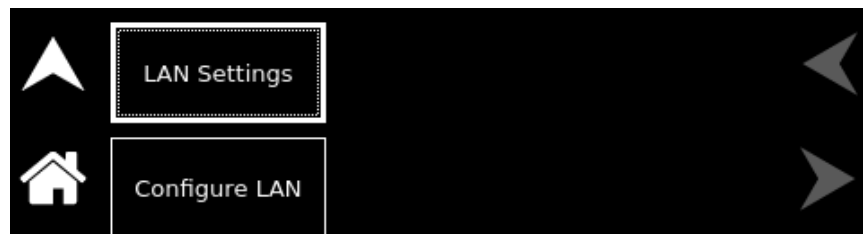

Figure 3-107: LAN Menu Screen

Entry	Description
LAN SETTINGS:	Lists the configuration settings of the LAN interface. Refer to Figure 3-108.

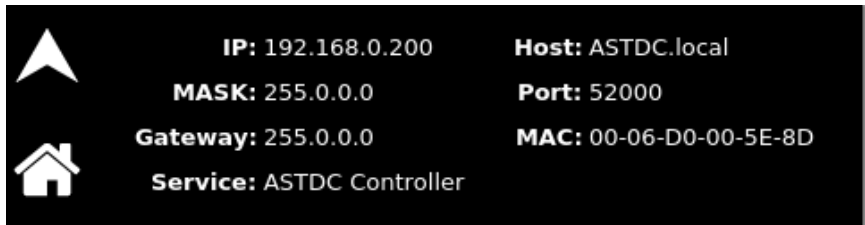

Figure 3-108: LAN Screen (Settings)

LAN CONFIGURE: Sets parameter values and controls operation of the LAN interface; refer to Figure 3-109.

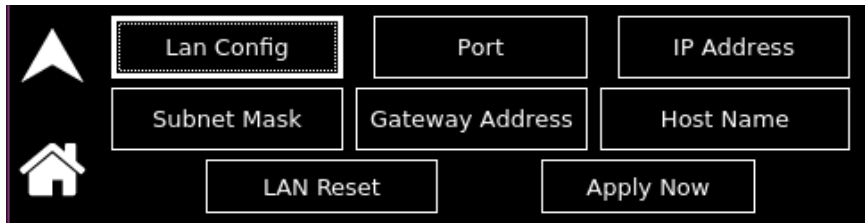

Figure 3-109: LAN Screen DHCP disabled (Configure)

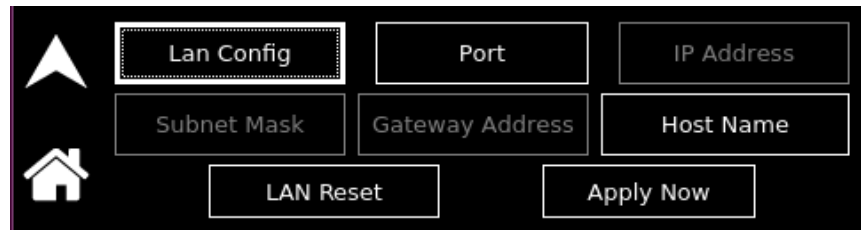

Figure 3-110: LAN Screen DHCP enabled (Configure)

LAN Config (DHCP): Selects whether DHCP is enabled or disabled. Refer to Figure 3-111. If DHCP is enabled (ON) user cannot set the IP Address, Subnet Mask and Gateway address these fields will be inactive refer Figure 3-110.

NOTE: When DHCP is selected, the IP address is assigned by the network DHCP server. If DHCP server fails to assign an IP address and Auto-IP is enabled, the unit gets an IP address in the range of 169.254.X.X.

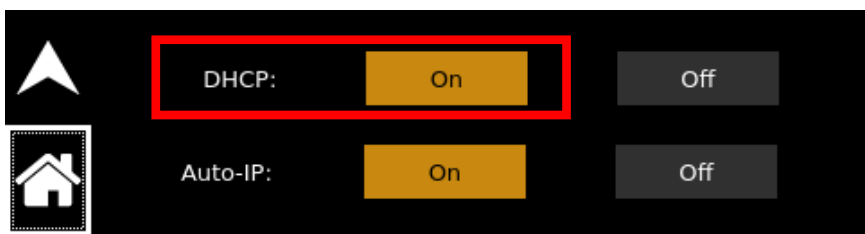

Figure 3-111: LAN Screen (DHCP)

Auto-IP: Enables or disable the Auto-IP configuration, when DHCP is ON. Refer to Figure 3-112.

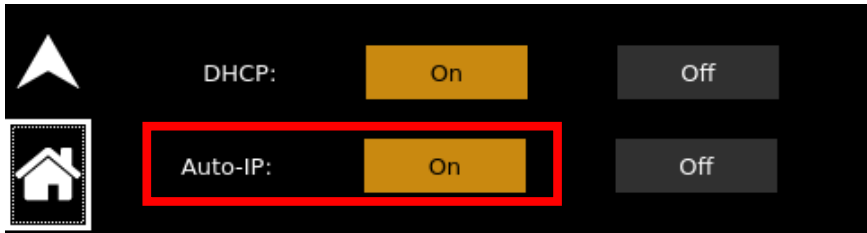

Figure 3-112: LAN Screen (Auto IP)

Host Name: Allows setting a unique alpha-numeric host name. Refer to Figure 3-113.



Figure 3-113: LAN Screen (Host Name)

Port: Sets the port number; the factory-default value is 52000. Refer to Figure 3-114.

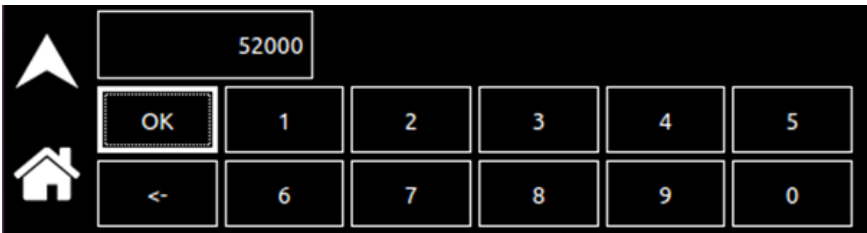

Figure 3-114: LAN Screen (Port)

IP Address: Sets the static IP address for the unit. Refer to Figure 3-115.



Figure 3-115: LAN Screen (IP Address)

Subnet Mask: Sets the subnet mask for use in static IP configuration. Refer to Figure 3-116.

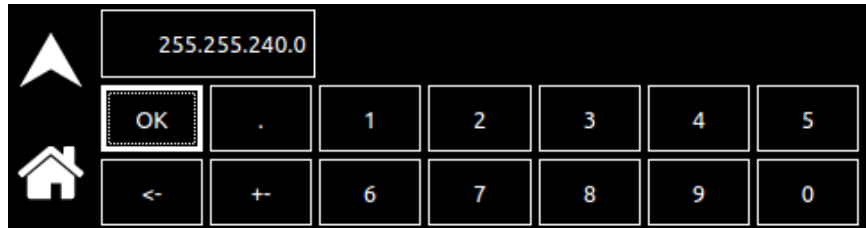

Figure 3-116: LAN Screen (Subnet Mask)

Gateway Address: Sets the gateway address for use in static IP configuration. Refer to Figure 3-117.

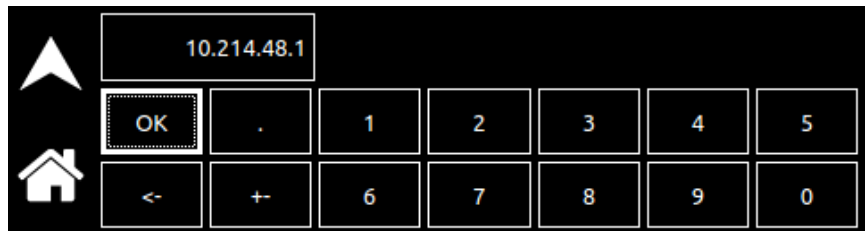

Figure 3-117: LAN Screen (Gateway Address)

NOTE: When DHCP is selected, the gateway address is assigned by the network DHCP server.

Restore Default: When Restore Default is pressed, a confirmation window will pop-up. After user confirmation, LAN settings will be set to factory Default. Refer to Figure 3-118.

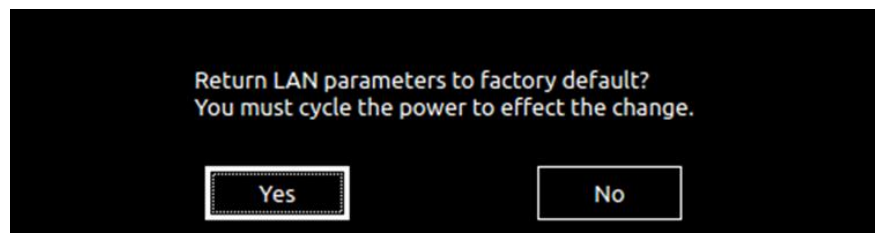

Figure 3-118: LAN Screen (Restore Default)

Apply Now: Applies the LAN settings to the supply. Refer to Figure 3-119.

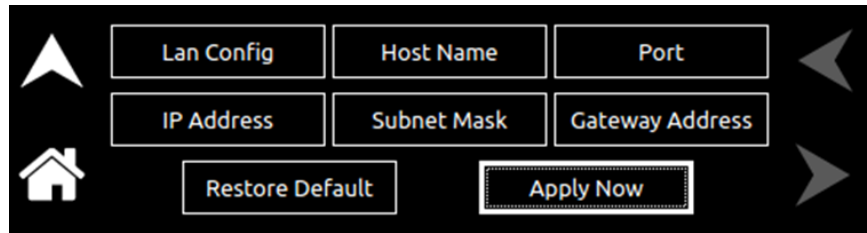

Figure 3-119: LAN Screen (Apply)

3.4.9.3 ANALOG

Sets the Remote Analog programming interface Configurations. Analog menu contains below sub menus; refer to Figure 3-120.

- Reference Source Settings
- Reference Source Configuration
- Configure Full Scale Value

Up-arrow will return to Control Interface menu screen; Refer Figure 3-101. Home button will return to HOME MENU screen 2; Refer Figure 3-18.

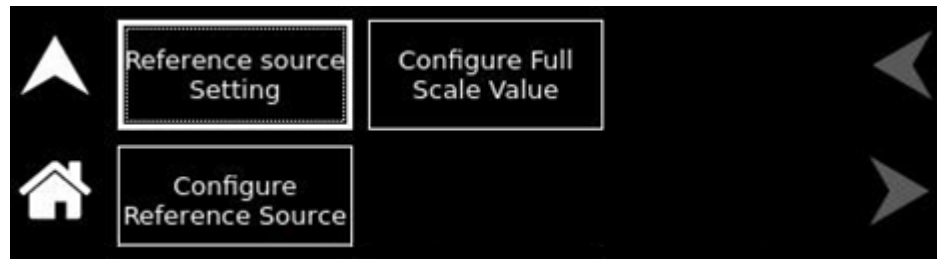

Figure 3-120: Analog Screen

3.4.9.3.1 Reference Source Settings

Lists the configuration settings of Analog Programming Interface configurations for individual channels. Refer Figure 3-121.

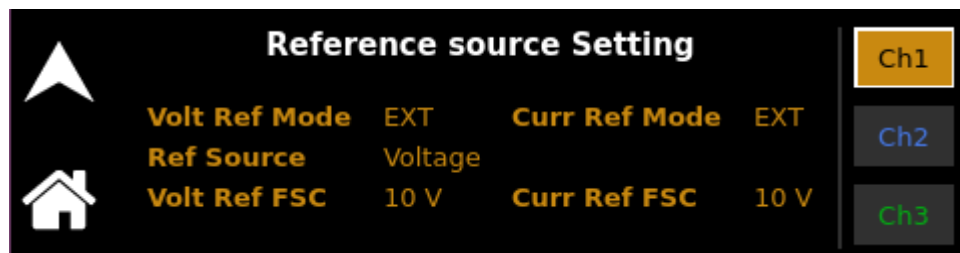

Figure 3-121: Reference Source Settings -Channel 1

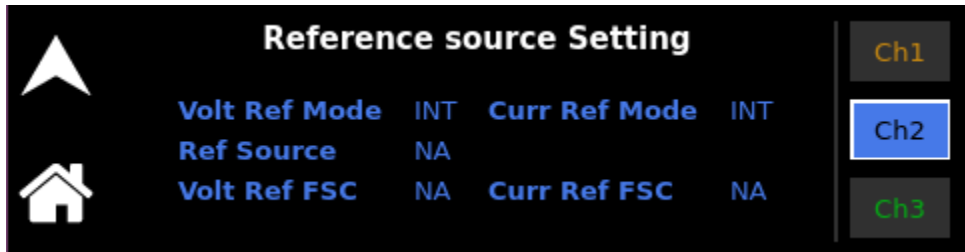

Figure 3-122: Reference Source Settings – Channel 2

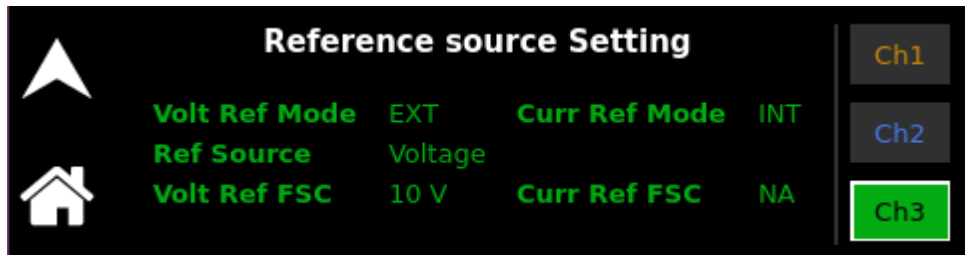

Figure 3-123: Reference Source Settings – Channel 3

3.4.9.3.2 Configure Reference Source

Allows to Configure the Reference Source; refer to Figure 3-124. default Reference source is programmed PONS – Analog Reference Source configurations (refer Figure 3-74). Reference source is common for analog voltage and current programming interface. For a given channel reference source would be same for both output voltage and current analog programming.

Sets the analog reference source either Voltage or Resistive for Selected channels, Refer Figure 3-124.

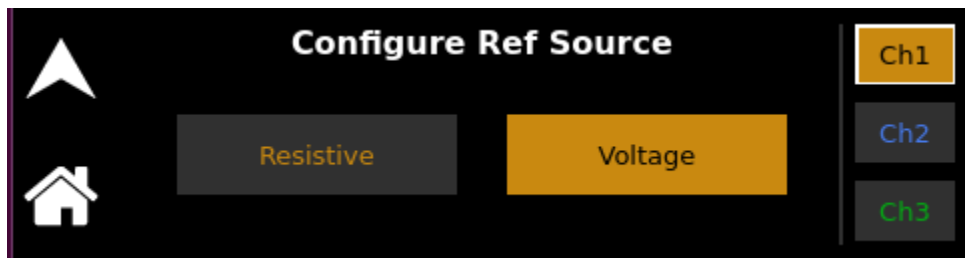

Figure 3-124: Configure Reference Source– Channel 1

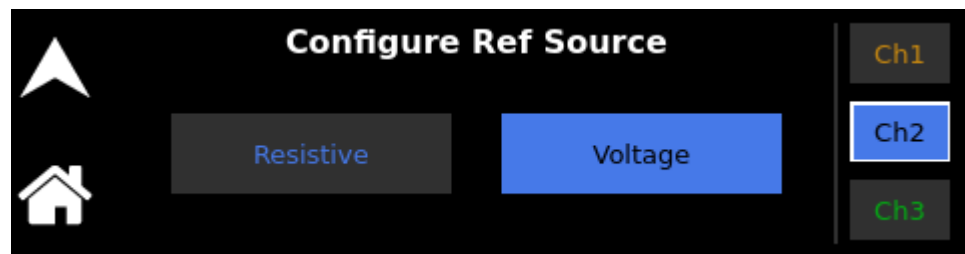

Figure 3-125: Configure Reference Source – Channel 2

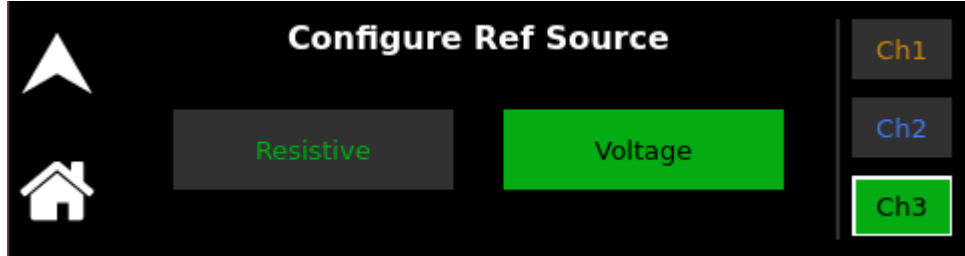

Figure 3-126: Configure Reference Source – Channel 3

Entry	Description
Voltage	Configures analog programming reference source as voltage source for selected channels. Voltage is the factory default reference source.
Resistive	Configures analog programming reference source as resistance for selected channel.

3.4.9.3.3 Configure Full Scale Value

Sets the analog programming Full Scale Value (FSC) of Voltage and Current programming for Selected channels, Refer Figure 3-128. default FSC value for both analog voltage and current programming is PONS – Configure Full Scale Value.

Full Scale for Voltage parameter field box will be inactive (refer Figure 3-127) if analog voltage ref mode is set to INT (internal).

Full Scale for Current parameter field box will be inactive (refer Figure 3-130) if analog current ref mode current is set to INT.

Full Scale for Voltage parameter field box will be active (refer Figure 3-130) if analog voltage ref mode is set to EXT (external) or INT + EXT (internal + external).

Full Scale for Current parameter field box will be active (refer Figure 3-130) if analog current ref mode is set to EXT (external) or INT + EXT (internal + external).

If configure ref source is selected as resistive of selected channel the respective channel unit of FSC value will become to kΩ (Kilo Ohms) and if voltage is selected as configure ref source (refer to Figure 3-125.) of selected channel the respective channel unit of FSC value will become to V (volts) refer to Figure 3-129.

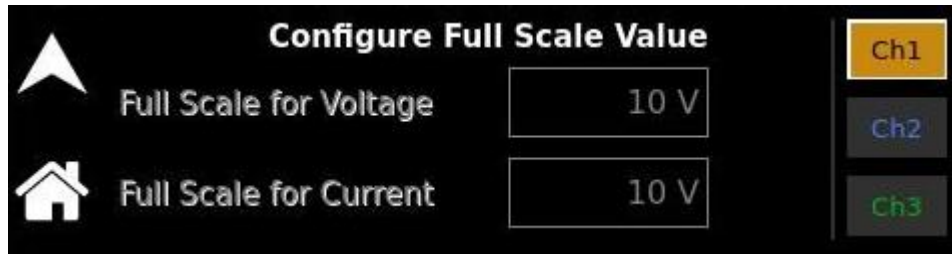

Figure 3-127: Configure Full Scale Value screen channel-1

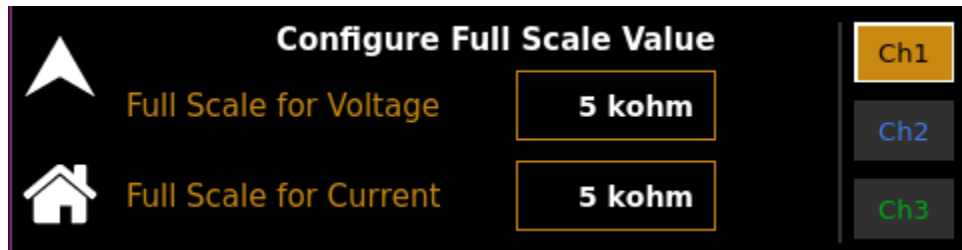

Figure 3-128: Configure Full Scale Value screen channel-1

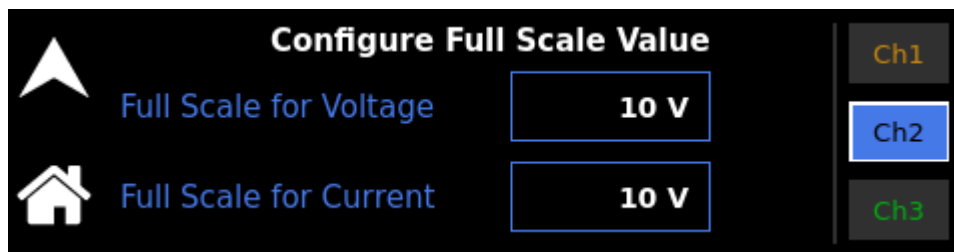

Figure 3-129: Configure Full Scale Value screen channel-2

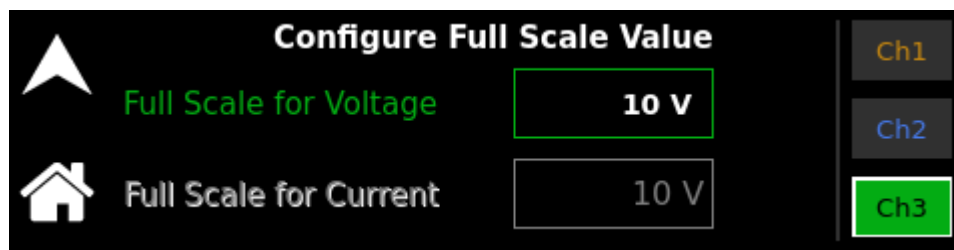

Figure 3-130: Configure Full Scale Value screen channel-3

Entry	Description
FSC Voltage	Sets FSC value for analog voltage programming of the supply, FSC (Full scale) value can be programmed from 5V to 10V for voltage source as reference and 5 kΩ to 10 kΩ for resistive reference source.

FSC Current Sets FSC value for analog current programming of the supply, FSC (Full scale) value can be programmed from 5V to 10V for voltage source as reference and 5 kΩ to 10 kΩ for resistive reference source.

3.4.9.4 USB

Lists the configured Baud Rate. Refer Figure 3-131.



Figure 3-131: USB Screen

3.4.9.5 GPIB

Sets the IEEE-488 Address, refer to Figure 3-132. Also allows to turn On/Off the Power ON Service Request. Power On SRQ set to ON causes a GPIB service request to be sent to the computer when the Power Supply is turned on. Factory Default value for Power On SRQ is Off.

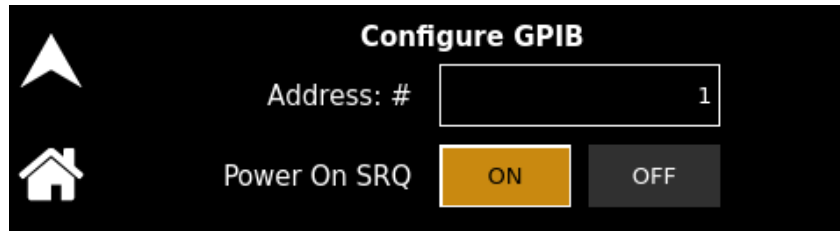

Figure 3-132: GPIB address setting Screen

Entry	Description
Address	Sets the IEEE -488 address. The address could be set from 1 through 30, the default address is 1.
ON	Sets the power On SRQ to ON.
OFF	Sets the power On SRQ to OFF.

3.4.10 System Settings Screen

The System Settings screen provides information on System Status, Firmware Version, Hardware Limits, LCD Brightness, Default Screen Timeout and allows to Reset the power supply to Factory Default settings.

The top-level menu of the System Settings menu is shown in Figure 3-133. Refer to Section 3.4.2.1 for navigating to System Settings Screen.

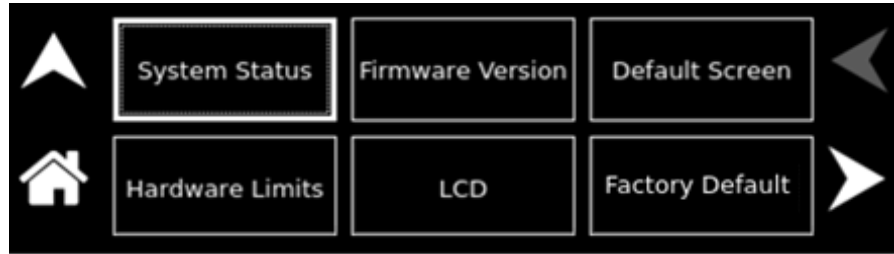

Figure 3-133: System Settings Menu Screen

The following menus are available in the System Settings Screen top-level menu: System Status, Firmware Version, Hardware Limits, Language, LCD Brightness, Default Screen and Factory Default.

<u>Entry</u>	<u>Description</u>
System Status	Displays the present status of the power supply, status of Regulation Mode, Output State, Input Phase, Input Line and Output Voltage sense. Refer to Figure 3-134.

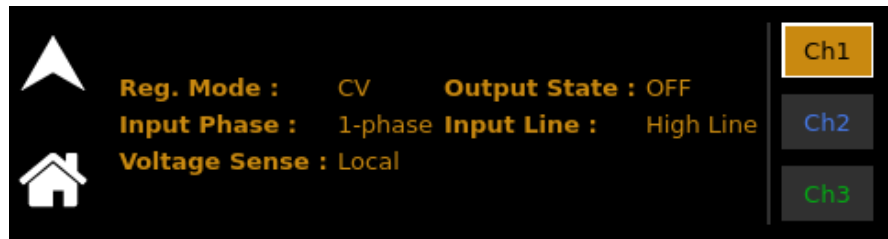

Figure 3-134: System Settings Screen (channel 1 Status)

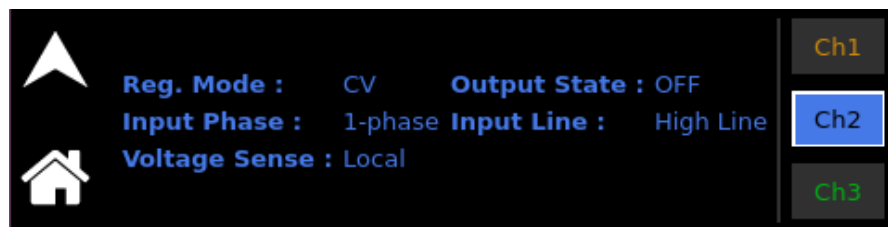

Figure 3-135: System Settings Screen (channel 2 Status)

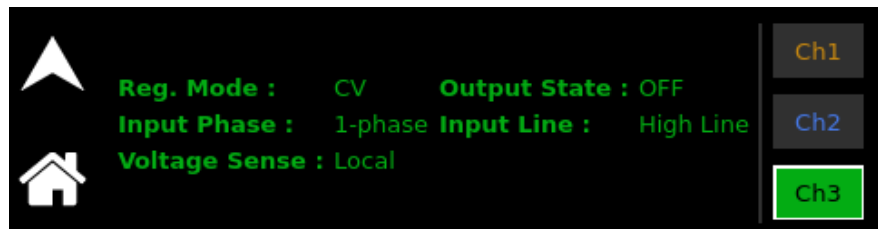

Figure 3-136: System Settings Screen (channel 3 Status)

Firmware Version

Displays information about the configuration of the power source. It has information such as manufacturer, model number, serial number, firmware version and Last Calibration Date. This information helps identify the unit. Refer to Figure 3-137.

Firmware Version screen displays following three types of firmware versions refer Figure 3-137. In the screen 3.116 represents firmware version of System Controller, 4.13 represents firmware version of DC Analog Interface (AIB) and 1.091 represents firmware version of Front Panel.

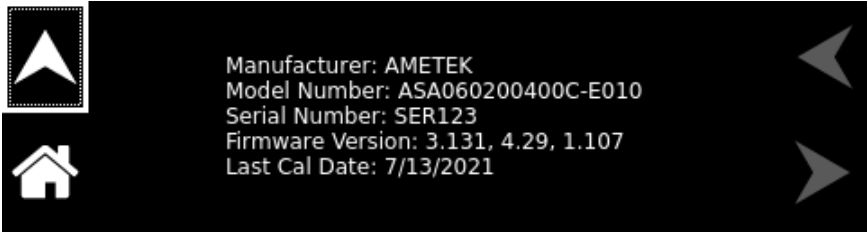

Figure 3-137: System Settings Screen (Version)

Hardware Limits

Displays the hardware parameter limit values. Refer to Figure 3-138:.

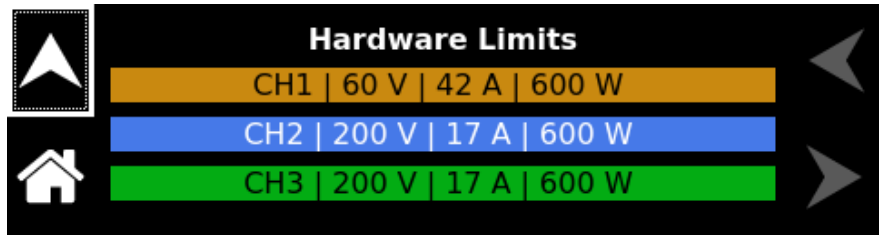

Figure 3-138: System Settings Screen (Hardware Limits)

LCD Brightness

Sets the brightness of the LCD backlight, as a percentage of the maximum that is available; the default setting is 70%. Tapping on the Right or Left arrow buttons or selecting them with the encoder and clicking the encoder switch, will increment/decrement the brightness by 10%, respectively. Refer to Figure 3-139 and Figure 3-140.

LCD Calibration

User Can calibrate the touchscreen with this utility for better accuracy of the Touch. Refer to Figure 3-139 and Figure 3-141. Follow the on screen guide to complete the calibration.

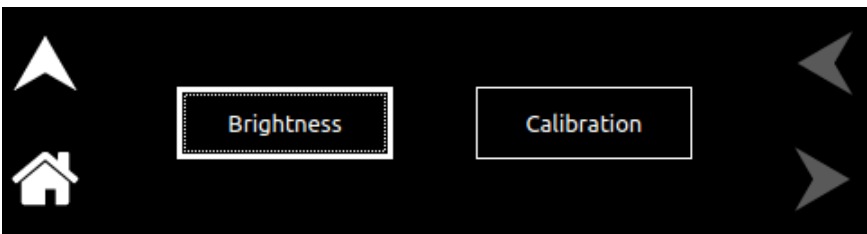

Figure 3-139: System Settings Screen (LCD Settings)

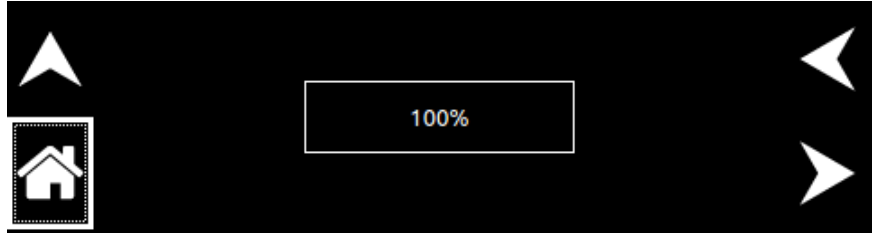

Figure 3-140: System Settings Screen (LCD Settings) Brightness

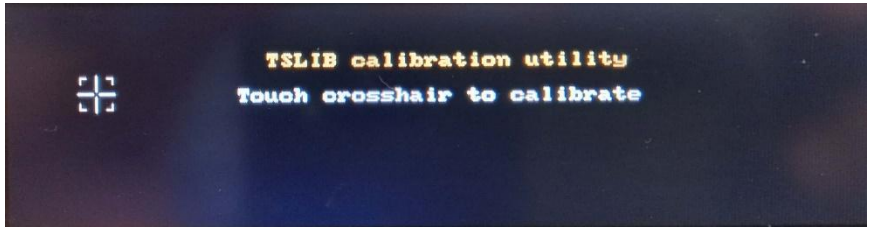

Figure 3-141: System Settings Screen (LCD Settings) Calibration

Default Screen

Selects whether the Default screen (showing measured voltage, current and power) is enabled or disabled, refer to Figure 3-142. It allows to set the time out if the default screen is enabled.

Timeout Interval: Selects the time, in seconds, for how long Dashboard screen must be inactive before the Default screen is displayed.

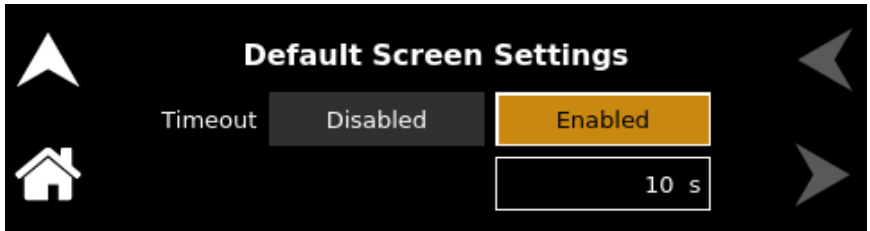

Figure 3-142: System Settings Screen (Default Screen Enabled)

Factory Default

Sets the Power supply settings and values to its Default. This also resets the Remote Analog Programming settings to its default status. A confirmation window will pop-up when Factory Default is pressed. The power supply will reset to its default after user confirmation. Refer to Figure 3-143.

NOTE: This will not reset LAN configuration

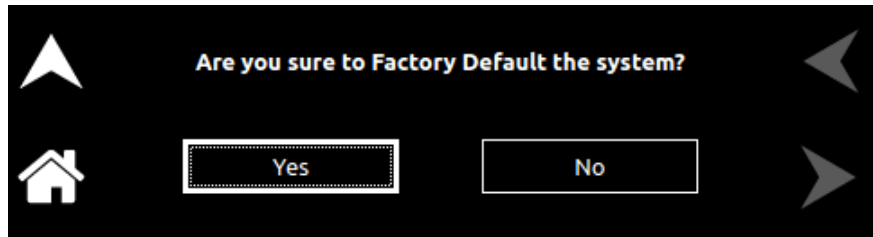

Figure 3-143: System Settings Screen (Factory Default)

3.4.11 Warning/Fault Screen

The following warning/Fault screen may appear during supply fault condition, refer to Figure 3-144. Pressing on View Faults will display all the Fault/Warning description with an option to clear the Fault. User should press Clear Fault button from the clear fault screen (refer Figure 3-145) to continue the operations of the power supply and clear the fault.

These warnings indicate description of Faults which has occurred in a power module, refer Table 3-3. These conditions might clear themselves, however, if they continue to occur after pressing the clear Fault; refer Figure 3-145. contact the factory for service assistance.

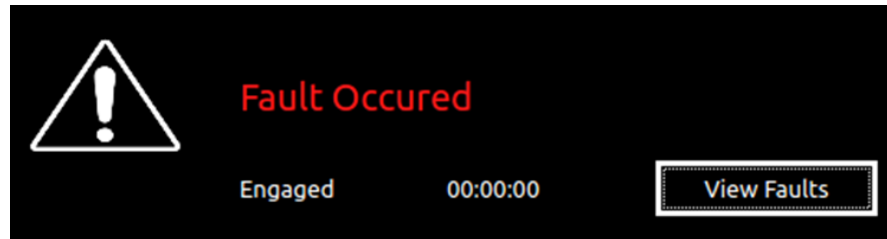

Figure 3-144: Fault Screen

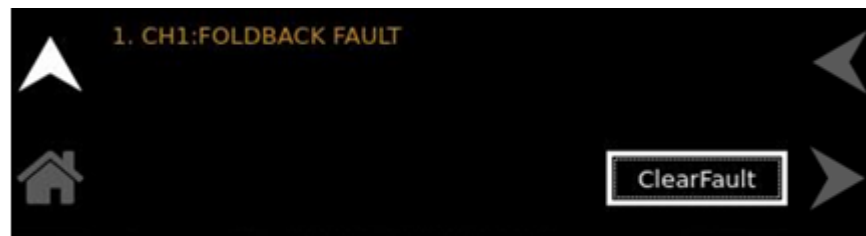

Figure 3-145: Clear Fault Screen

Mentioned below are the power supply's fault conditions:

Fault	Description	Action
OVP FAULT	Output voltage exceeded Over Voltage trip limit.	Check sufficient margin between set voltage and Over Voltage Protection limit.

DC MODULE OTP FAULT	Power supply internal hardware temperature exceeded limit	Check and make sure there are no Air blockage in the front and rear of the power supply. Make sure Ambient temperature and the Operating Power limit with input line condition is as per the Specifications. If fault persists, Contact factory.
EXTERNAL SHUTDOWN	External Shutdown activated from DB 26 External User Interface Connector	Make sure Pin 7 and Pin 8 are connected for disabling External Shutdown of channel 1, Pin 16 and Pin 17 are connected for disabling External Shutdown of channel 2, Pin 25 and Pin 26 are connected for disabling External Shutdown of channel 3.
FOLDBACK FAULT	Trip activated due to foldback operation setting	Power supply is not regulating as per the regulation mode settings. Check the regulation mode settings as required for the load type. Check the programming parameters of output voltage, current to meet the load requirement and the regulation mode setting selected.
FAN FAULT	Fault from cooling Fan	This condition is caused by Fan's not running properly. Reset the fault or try restarting the power supply and If fault persists, Contact factory.
LINE DROP FAULT	Input voltage to the power supply is not in operating range	Check if input voltage to the supply is within specified range in datasheet.
DC FAULT	Internal DC module hardware fault	Try restarting the power supply if fault persists Contact factory.
PFC FAULT	Internal PFC module hardware fault	Try restarting the power supply if fault persists Contact factory.
OCP FAULT	Output current exceeds Over Current trip limit	Check sufficient margin between set current and Over Current trip limit.
AUX SUPPLY FAULT	Auxiliary Supply to internal hardware fault	Try restarting the power supply if fault persists Contact factory.
LINE STATE CHANGE	Input voltage changed from Low range to High range or vice versa	Make sure input voltage is stable at one voltage range. If there is change over in input voltage range power supply's output power limits will be reset based on the limits specified in datasheet.
REMOTE SNS ERROR	Remote voltage sensing is out of range from power supply capacity or cable connected to Output and Remote Sense connector fault	Check if the Remote Sense cable connected to Output and Remote Sense Connector at rear side power supply, Cables are intact, and polarity is correct. Check the output cable voltage drop and make sure voltage drop across cable is not exceeding limit specified in datasheet.
CALIBRATION FAULT	Calibration command is incorrect or entered parameter with command is incorrect.	Verify the SCPI command sent from remote communication interface is as per programming manual. Verify command sent are not violating any user limits or hardware parameter range specified in datasheet of power supply
PFC MODULE OTP FAULT	Power supply internal hardware temperature exceeded limit	Check and make sure there are no Air blockage in the front and rear of the power supply. Make sure Ambient temperature and the Operating Power limit with input line condition is as per the Specifications. If fault persists, Contact factory

Table 3-3: Fault Conditions

3.4.12 Local/Remote Screen

This screen is displayed when the power supply operations are only controlled by digital communication interfaces with lock symbol. Pressing Lock symbol (Refer to Figure 3-146) from Local/Remote Screen returns the power supply front panel to Local mode and Home Screen menu. This permits the user to control the operations of power supply from the front panel.

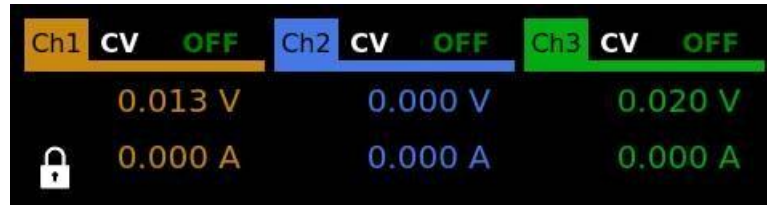

Figure 3-146: Local/Remote Screen

3.5 Output Verification

3.5.1 Constant-Voltage Mode Operation

Constant-Voltage Mode (CV) operation is individual for each channel, the output voltage is regulated at the programmed value while the output current varies with the load requirements. The voltage could be programmed separately for each channel either through the front panel or by the remote analog voltage programming input. To verify operation in Constant-Voltage mode, follow these steps:

1. Ensure that there is no load connected to the output.
2. Ensure that the remote sense is connected to the output terminals.
3. Connect a digital voltmeter (DVM) across the rear panel positive and negative output terminals, observing the correct polarity. Make sure the DVM is in the DC voltage mode and the range is adequate to handle the full-scale voltage of the power supply.
4. Apply power to the AC mains input and turn on the power supply.
5. If the Power ON Settings (PONS) had previously been configured to be OFF, when the supply reaches the Dashboard Screen, enable the output by pressing the "Output On/Off".
6. Use the Dashboard Screen to program the Voltage and Current.
7. Program the Current to 10% of rated output by entering the value in the "Setting" section on the Dashboard Screen. Program the current above zero to enable supplying output current while in the constant-voltage mode.

8. On the Dashboard screen, rotate the rotary knob to select the “Voltage” text box in the “Setting” section. Press the rotary knob to highlight the voltage value. Rotate the rotary knob clockwise and observe both the voltage display in the “Measure” section on the Dashboard screen and output of the DVM begin to accelerate up. The output voltage should increase from 0 V to the maximum rated voltage of the supply. The voltage display in the “Measure” section on the Dashboard screen and DVM readings should track within the accuracies of the meter and the Dashboard.
9. Verify the Constant Voltage (CV) Mode appears on Dashboard screen.
10. Program the Voltage and Current back to zero.
11. Turn the power supply off.

If Constant-Voltage mode operation did not function as indicated above, verify the setup, and perform the check again. If the function continues to fail, contact the factory for assistance.

3.5.2 Constant-Current Mode Operation

Constant-Current Mode (CC) operation is individual for each channel, In CC mode the output current is regulated at the selected value while the output voltage varies with the load requirements. The current could be programmed each channel individually either through the front panel or by the remote analog current programming input. To verify operation in Constant-Current mode, follow these steps:

1. If the output had been previously energized, allow 5 minutes for the output capacitors to discharge. Connect a high current DC ammeter across the rear panel positive and negative output terminals any one of the channels, observing the correct polarity. Select wire leads of sufficient current carrying capacity and an ammeter range compatible with the units maximum rated output current.
Note: Verification that the supply could source rated output current, without measuring the current with an ammeter, but using only the front panel meter, could be performed by shorting the output terminals together.
2. Turn on the power supply.
3. If the Power ON Settings (PONS) had previously been configured to be OFF, when the supply reaches the Dashboard Screen, enable the output by pressing the “Output On/Off” for selected channel.
4. Use the Dashboard Screen to program the Voltage and Current.
5. Program the Voltage to 10% of rated output by entering the in the “Setting” section on the Dashboard Screen. This programs the Voltage above zero to enable supplying output voltage while in the constant-current mode.

6. On the Dashboard screen, rotate the rotary knob to select the “Current” text box in the “Setting” section. Press the rotary knob to highlight the current value. Rotate the rotary knob clockwise and observe both the current display in the “Measure” section on the Dashboard screen and output of the DC ammeter begin to accelerate up. The output current should increase from 0 A to the maximum rated current of the supply. The current display in the “Measure” section on the Dashboard screen and DC ammeter readings should track within the accuracies of the meter and the Dashboard.
7. Verify the Constant Current Mode (CC) appears on the Dashboard screen.
8. Program the Voltage and Current back to zero.
9. Turn the power supply off.
10. Allow 5 minutes for the output capacitors to discharge and disconnect the ammeter or short from the output terminals.
11. If Constant-Current mode operation did not function as indicated above, verify the setup, and perform the check again. If the function continues to fail, contact the factory for assistance.

3.5.3 Overvoltage Protection

The Overvoltage Protection (OVP) function is individual for each channel and allows the supply to shut down the output respected channel if it were to exceed a preset voltage. This may be used to protect sensitive circuits or loads from damage caused by an excessive voltage on the output of the supply. The Overvoltage Protection (OVP) could be programmed through the front panel individually for each channel. To verify OVP operation, follow these steps:

1. Make sure there is nothing connected across the output terminals.
2. Turn on the power supply.
3. If the Power ON Settings (PONS) had previously been configured to be OFF, when the supply reaches the Dashboard Screen, enable the output by pressing the “Output On/Off”.
4. Use the Output Program Screen to program the Voltage, Current and OVP.
5. Program the Current to 10% of rated output (program the current above zero to enable supplying output current while in the constant-voltage mode).
6. The factory default setting is approximately 110% of the maximum rated output of the supply. On the Output Program screen, rotate the rotary knob to set the “OVP”. Press the rotary knob to highlight the OVP value. Rotate the rotary knob anti-clockwise until the OVP is programmed to about 80-90% of the maximum rated output voltage.

7. On the Dashboard screen, rotate the rotary knob to select the “Voltage” text box in the “Setting” section. Press the rotary knob to highlight the voltage value. Rotate the rotary knob clockwise and observe the voltage display in the “Measure” section on the Dashboard screen begin to accelerate up. When the output voltage exceeds the OVP trip point, the OVP warning screen will be displayed saying that the output tripped due to an OVP fault.
8. The Output State will be programmed to **OFF**, and the Voltage, Current, and OVP settings will retain their previous settings.
9. Press “Clear OVP” on OVP Warning screen and the fault screen will clear. The Dashboard screen will be displayed, and the output will remain disabled.
10. Using the Dashboard screen, program the OVP setting as appropriate for the application. If OVP is not used, then “OVP” programming may be set at maximum, approximately 110% of the rated output voltage of the supply.
11. If OVP mode did not function as indicated above, verify the setup, and perform the check again. If the function continues to fail, contact the factory for assistance.

3.5.4 Constant-Power Mode

The Constant-Power Mode (CP) is individual for each channel. Constant-Power Mode allows the supply to regulate the output to a constant power setting as opposed to the more common constant voltage or constant current modes of operation. (**Note:** Constant Power mode is intended primarily for loads with response times greater than approximately 10ms). While in this mode, the supply will continually adjust the voltage and current levels to attempt to maintain a constant power to the load. To provide additional protection for the load, voltage, and current limits may be set while in the Constant-Power mode. If the unit cannot regulate to the Constant Power setting due to load conditions, it will regulate either at the voltage or current limit depending on the load demand. Refer to Figure 3-147.

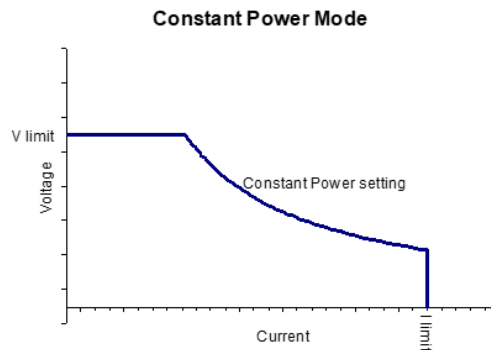

Figure 3-147: Constant-Power Example

REMOTE EXTERNAL USER INTERFACE CONTROL

4.1 Introduction

The Power supply provided with External User Interface Control connector on the rear panel allows the unit to be configured for different operating configurations of each channel. This chapter contains setup and operating configuration of Output ON/OFF, Regulation Mode status, Fault status, Remote inhibit (E-stop) and Trigger Functions. Refer to Figure 4-1 for the connector pin-out diagram and Table for connector pin-out details. The setup and operating requirements of each configuration are provided in Sections 4.2 and 4.3.

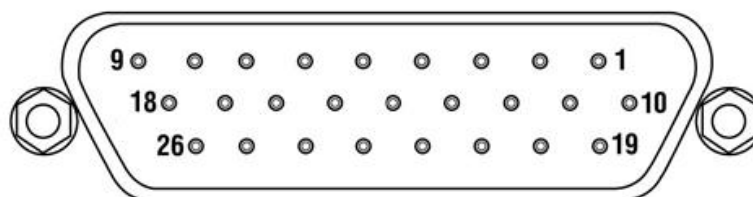

Figure 4-1: External User Interface Connector

Pin	Signal	Type	Description
Channel-1 Signals (Pin number 1 to 9)			
1	TRIG1-IN	DIGITAL INPUT	Input signal, TTL active-high; provides external hardware triggering of voltage and current ramp functions. Signal connects to Open-anode of opto-isolator diode with 1k Ω series resistor internal to power supply. Signal return: Pin 8 Voltage Rating: Maximum 24V, Minimum -5V Low state 0.3V max, High State 2.7V min.



2	TRIG1-OUT	DIGITAL OUTPUT	<p>Output signal, active-high; synchronization pulse of 10 ms when a change in the output occurs.</p> <p>Open collector transistor output, Collector is connected the 26-pin connector. Emitter point of transistor is connected to common return pin of the interface connector.</p> <p>Signal return: Pin 8</p> <p>Voltage Rating: Maximum 30V, Minimum 3V for Active High, Sink Current: 50mA</p>
3	CH1-FAULT-STATUS	DIGITAL OUTPUT	<p>Output Signal, High state indicates fault state of the power supply.</p> <p>Open collector transistor output, Collector is connected the 26-pin connector. Emitter point of transistor is connected to common return pin of the interface connector.</p> <p>Signal return: Pin 8</p> <p>Voltage Rating: Maximum 30V, Minimum 3V for Active High, Sink Current: 50mA</p>
4	CH1-OUTPUT-ON-OFF	DIGITAL INPUT	<p>Remote-control input for output on/off with a logic signal: a logic-high, will enable (turn-on) the output of the supply, and a logic-low signal disables (turns off) the output.</p> <p>Signal connects to Open-anode of opto-isolator diode with 1kΩ series resistor internal to power supply</p> <p>Signal return: Pin 8</p> <p>Voltage Rating: Maximum 24V, Minimum -5V</p> <p>Low state 0.3V max, High State 2.7V min.</p>
5	CH1-CV/CC-STATUS	DIGITAL OUTPUT	<p>User digital output. Output low for Constant Voltage (CV) mode and high for Constant Current (CC) mode.</p> <p>Open collector transistor output, Collector is connected the 26-pin connector. Emitter point of transistor is connected to common return pin of the interface connector.</p> <p>Signal return: Pin 8</p> <p>Voltage Rating: Maximum 30V, Minimum 3V for Active High, Sink Current: 50mA</p>
6	CH1-OUTPUT-ON/OFF-STATUS	DIGITAL OUTPUT	<p>Output Signal, High state indicates output of the power supply is enabled.</p> <p>Open collector transistor output, Collector is connected the 26-pin connector. Emitter point of transistor is connected to common return pin of the interface connector.</p> <p>Signal return: Pin 8</p> <p>Voltage Rating: Maximum 30V, Minimum 3V for Active High, Sink Current: 50mA.</p>
7	CH1-Remote Inhibit	Input Switch/Relay Contact	<p>Switch/Relay contact closure or direct short from this terminal to signal return is required to enable/disable the output of the power supply. Opening the contact would disable the output. Upon contact closure, if remote inhibit is selected as live mode, the fault would be cleared, and output could be enabled from the front panel or by issuing the SCPI command.</p> <p>If remote inhibit is selected as Latch mode, the output will be disabled, Output could not be enabled upon the contact closure. Fault should be cleared by issuing the SCPI command <code>OUTP<n>:PROT:CLE</code> or by clearing the fault from the front panel screen.</p> <p>Remote circuit must sink up to 10mA from 5 VDC to enable.</p> <p>Signal return: Pin 8</p>

8	RTN	RETURN	Return/GND. Pins 8,17 and 26 are shorted internal to the power supply.
9	NC	N/A	No Connection
Channel-2 Signals (Pin number 10 to 18)			
10	TRIG2-IN	DIGITAL INPUT	<p>Input signal, TTL active-high; provides external hardware triggering of voltage and current ramp functions.</p> <p>Signal connects to Open-anode of opto-isolator diode with 1kΩ series resistor internal to power supply.</p> <p>Signal return: Pin 17</p> <p>Voltage Rating: Maximum 24V, Minimum -5V</p> <p>Low state 0.3V max, High State 2.7V min.</p>
11	TRIG2-OUT	DIGITAL OUTPUT	<p>Output signal, active-high; synchronization pulse of 10 ms when a change in the output occurs.</p> <p>Open collector transistor output, Collector is connected the 26-pin connector. Emitter point of transistor is connected to common return pin of the interface connector.</p> <p>Signal return: Pin 17</p> <p>Voltage Rating: Maximum 30V, Minimum 3V for Active High, Sink Current: 50mA</p>
12	CH2-FAULT-STATUS	DIGITAL OUTPUT	<p>Output Signal, High state indicates fault state of the power supply.</p> <p>Open collector transistor output, Collector is connected the 26-pin connector. Emitter point of transistor is connected to common return pin of the interface connector.</p> <p>Signal return: Pin 17</p> <p>Voltage Rating: Maximum 30V, Minimum 3V for Active High, Sink Current: 50mA</p>
13	CH2-OUTPUT-ON-OFF	DIGITAL INPUT	<p>Remote-control input for output on/off with a logic signal: a logic-high, will enable (turn-on) the output of the supply, and a logic-low signal disables (turns off) the output.</p> <p>Signal connects to Open-anode of opto-isolator diode with 1kΩ series resistor internal to power supply</p> <p>Signal return: Pin 17</p> <p>Voltage Rating: Maximum 24V, Minimum -5V</p> <p>Low state 0.3V max, High State 2.7V min.</p>
14	CH2-CV/CC-STATUS	DIGITAL OUTPUT	<p>User digital output. Output low for Constant Voltage (CV) mode and high for Constant Current (CC) mode.</p> <p>Open collector transistor output, Collector is connected the 26-pin connector. Emitter point of transistor is connected to common return pin of the interface connector.</p> <p>Signal return: Pin 17</p> <p>Voltage Rating: Maximum 30V, Minimum 3V for Active High, Sink Current: 50mA</p>
15	CH2-OUTPUT-ON/OFF-STATUS	DIGITAL OUTPUT	<p>Output Signal, High state indicates output of the power supply is enabled.</p> <p>Open collector transistor output, Collector is connected the 26-pin connector. Emitter point of transistor is connected to common return pin of the interface connector.</p> <p>Signal return: Pin 17</p> <p>Voltage Rating: Maximum 30V, Minimum 3V for Active High, Sink Current: 50mA.</p>
16	CH2-Remote Inhibit	Input Switch/	Switch/Relay contact closure or direct short from this terminal to signal return is required to enable/disable the output of the power supply.

		Relay Contact	<p>Opening the contact would disable the output. Upon contact closure, if remote inhibit is selected as live mode, the fault would be cleared, and output could be enabled from the front panel or by issuing the SCPI command.</p> <p>If remote inhibit is selected as Latch mode, the output will be disabled, Output could not be enabled upon the contact closure. Fault should be cleared by issuing the SCPI command <code>OUTP<n>:PROT:CLE</code> or by clearing the fault from the front panel screen.</p> <p>Remote circuit must sink up to 10 mA from 5 VDC to enable.</p> <p>Signal return: Pin 17</p>
17	RTN	RETURN	Return/GND. Pins 8,17 and 26 are shorted internal to the power supply.
18	NC	N/A	N/A
Channel-3 Signals (Pin number 19 to 26)			
19	TRIG3-IN	DIGITAL INPUT	<p>Input signal, TTL active-high; provides external hardware triggering of voltage and current ramp functions.</p> <p>Signal connects to Open-anode of opto-isolator diode with 1kΩ series resistor internal to power supply.</p> <p>Signal return: Pin 26</p> <p>Voltage Rating: Maximum 24V, Minimum -5V</p> <p>Low state 0.3V max, High State 2.7V min.</p>
20	TRIG3-OUT	DIGITAL OUTPUT	<p>Output signal, active-high; synchronization pulse of 10 ms when a change in the output occurs.</p> <p>Open collector transistor output, Collector is connected the 26-pin connector. Emitter point of transistor is connected to common return pin of the interface connector.</p> <p>Signal return: Pin 26</p> <p>Voltage Rating: Maximum 30V, Minimum 3V for Active High, Sink Current: 50mA</p>
21	CH3-FAULT-STATUS	DIGITAL OUTPUT	<p>Output Signal, High state indicates fault state of the power supply.</p> <p>Open collector transistor output, Collector is connected the 26-pin connector. Emitter point of transistor is connected to common return pin of the interface connector.</p> <p>Signal return: Pin 26</p> <p>Voltage Rating: Maximum 30V, Minimum 3V for Active High, Sink Current: 50mA</p>
22	CH3-OUTPUT-ON-OFF	DIGITAL INPUT	<p>Remote-control input for output on/off with a logic signal: a logic-high, will enable (turn-on) the output of the supply, and a logic-low signal disables (turns off) the output.</p> <p>Signal connects to Open-anode of opto-isolator diode with 1kΩ series resistor internal to power supply</p> <p>Signal return: Pin 26</p> <p>Voltage Rating: Maximum 24V, Minimum -5V</p> <p>Low state 0.3V max, High State 2.7V min.</p>
23	CH3-CV/CC-STATUS	DIGITAL OUTPUT	<p>User digital output. Output low for Constant Voltage (CV) mode and high for Constant Current (CC) mode.</p> <p>Open collector transistor output, Collector is connected the 26-pin connector. Emitter point of transistor is connected to common return pin of the interface connector.</p> <p>Signal return: Pin 26</p> <p>Voltage Rating: Maximum 30V, Minimum 3V for Active High, Sink Current: 50mA</p>

24	CH3-OUTPUT-ON/OFF-STATUS	DIGITAL OUTPUT	<p>Output Signal, High state indicates output of the power supply is enabled.</p> <p>Open collector transistor output, Collector is connected the 26-pin connector. Emitter point of transistor is connected to common return pin of the interface connector.</p> <p>Signal return: Pin 26</p> <p>Voltage Rating: Maximum 30V, Minimum 3V for Active High, Sink Current: 50mA.</p>
25	CH3-Remote Inhibit	Input Switch/Relay Contact	<p>Switch/Relay contact closure or direct short from this terminal to signal return is required to enable/disable the output of the power supply. Opening the contact would disable the output. Upon contact closure, if remote inhibit is selected as live mode, the fault would be cleared, and output could be enabled from the front panel or by issuing the SCPI command.</p> <p>If remote inhibit is selected as Latch mode, the output will be disabled, Output could not be enabled upon the contact closure. Fault should be cleared by issuing the SCPI command <code>OUTP<n>:PROT:CLE</code> or by clearing the fault from the front panel screen.</p> <p>Remote circuit must sink up to 10mA from 5 VDC to enable.</p> <p>Signal return: Pin 26</p>
26	RTN	RETURN	Return/GND. Pins 8,17 and 26 are shorted internal to the power supply.

Table 4-1: External user interface control connector pin out details

	<p>CAUTION!</p> <p>All the three channels signal returns (Pin 8, 17 and 26) are shorted internally to the power supply. Applying a voltage potential between them would damage the power supply.</p>
	<p>CAUTION!</p> <p>External User Control interface signals are isolated from negative output terminal; Isolation voltage is rated for ±600 VRMS, maximum; operation of Isolated Analog Interface signals should be at SELV safety voltage conditions to chassis ground.</p>

4.2 Remote Inhibit (Switch/Relay Contact Closure)

Remote External user interface (26 pin connector) provided with remote inhibit inputs for each channel; refer Table 4-1 for pin out details. A contact closure or direct shot between Remote Inhibit terminal and Return pin, will allow the output voltage to be programmed and enable the output.

Alternatively, open circuit between remote inhibit terminal and return will disable the Output.

The external user interface connector (26 pin connector) is supplied with a mating connector. This connector is provided with the remote inhibit connected (direct short) for all the channels.

A contact closure or direct shot between Remote Inhibit terminal and Return pin between Pins 7 and Pin 8 will permits the channel 1 output to Turn ON; refer Figure 4-2 for connection requirements.

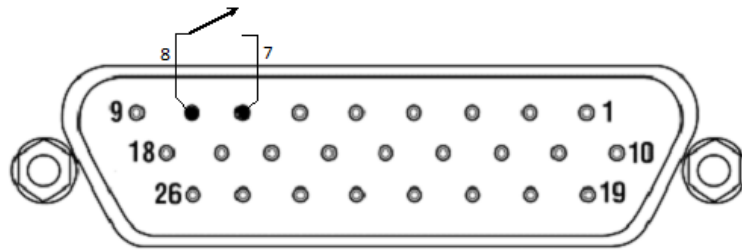

Figure 4-2: Output On/Off Control by Contact Closure channel 1

A contact closure between Pin 16 and 17 will permits the channel 2 output to Turn ON; refer Figure 4-3 for connection requirements.

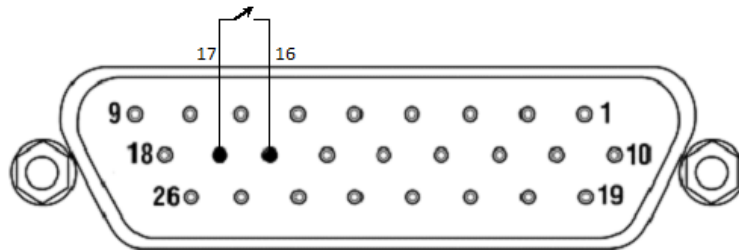

Figure 4-3: Output On/Off Control by Contact Closure channel 2

And contact closure between Pin 25 and 26 will permits the channel 3 output to Turn ON; refer Figure 4-4 for connection requirements.

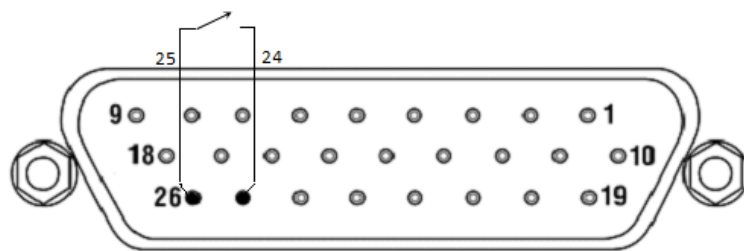

Figure 4-4: Output On/Off Control by Contact Closure channel 3

The Remote Inhibit will work under the following modes. The mode can be changed through available digital interface using SCPI command, `OUTP<n>:REMOTE:INHIBIT <1/0>` or selected from the front panel (refer Figure 4-5Figure 3-45):

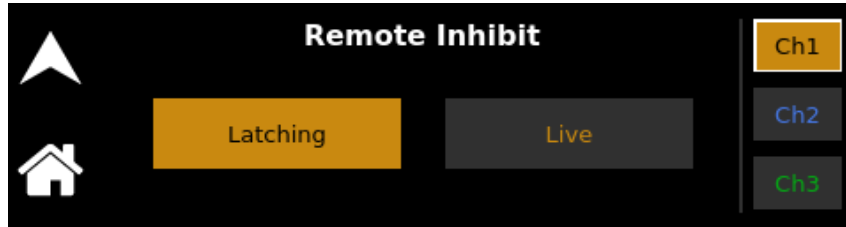

Figure 4-5: Remote Inhibit Mode

Note: The data format <n>represents individual channel number 1, 2 and 3.

LATC(hing) An open contact between remote inhibit terminal and return latches the output in the protection shutdown state; this state can be cleared either through the front panel fault screen (refer Figure 4-7) or by issuing the SCPI command, OUTP<n>:PROT:CLE.

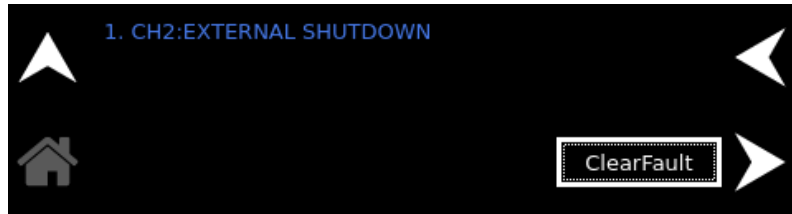

Figure 4-6: Remote Inhibit Clear Fault Screen

LIVE The output state follows the state of the Remote Inhibit input. An open contact between the remote inhibit terminal and return will disable the output; a contact closer will clear the fault.

Factory default mode is LIVE. With this default factory setting (connected remote inhibit 26 pin mating connector installed and the remote inhibit mode being LIVE), the user can turn ON and OFF the power supply with the output switch.

User can remove the hardwired jumpers in the remote inhibit 26 pin female connector and wire to a contact closure as per their requirement. User would need to select the mode of remote inhibit using the front panel screen refer Figure 4-5, according to their requirement of fault clearance.

For additional information on programming the Remote Inhibit function, refer to the Asterion DC Multioutput Programming Manual P/N M330517-01. Refer to AMETEK Programmable Power website, www.powerandtest.com, to download latest version. correlate

4.3 Remote Output ON/OFF Control by External Source

Application of DC voltage (2.7-24V) between Pins 4 and 8, will Enable the Output of Channel 1, DC voltage (2.7-24V) between Pins 13 and 17, will Enable the Output of Channel 2 and DC voltage (2.7-24V) between Pins 22 and 26, will Enable the Output of Channel 3. This interface is opto-isolated from circuit common. See Figure 4-7, Figure 4-8 and Figure 4-9 for connection requirements.

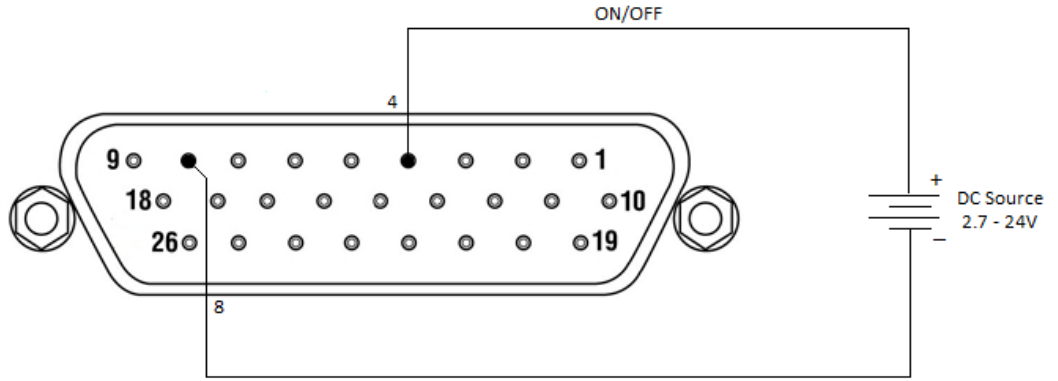

Figure 4-7: Remote Output On/Off Using DC Source Channel 1

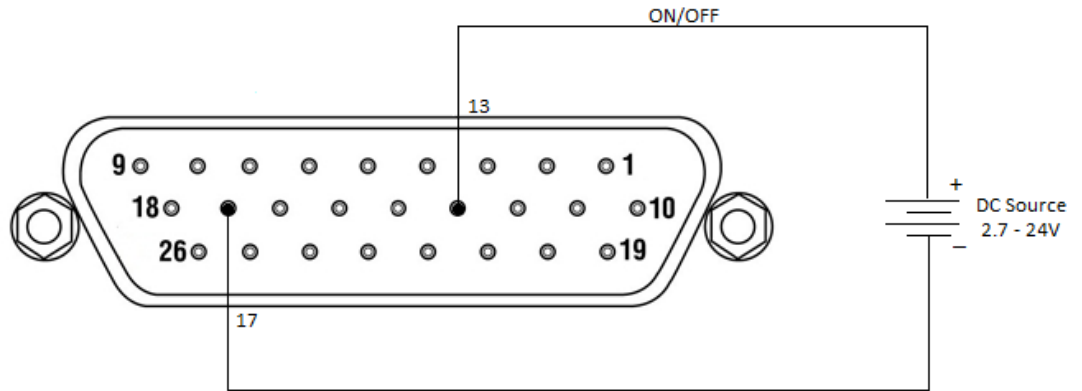

Figure 4-8: Remote Output On/Off Using DC Source Channel 2

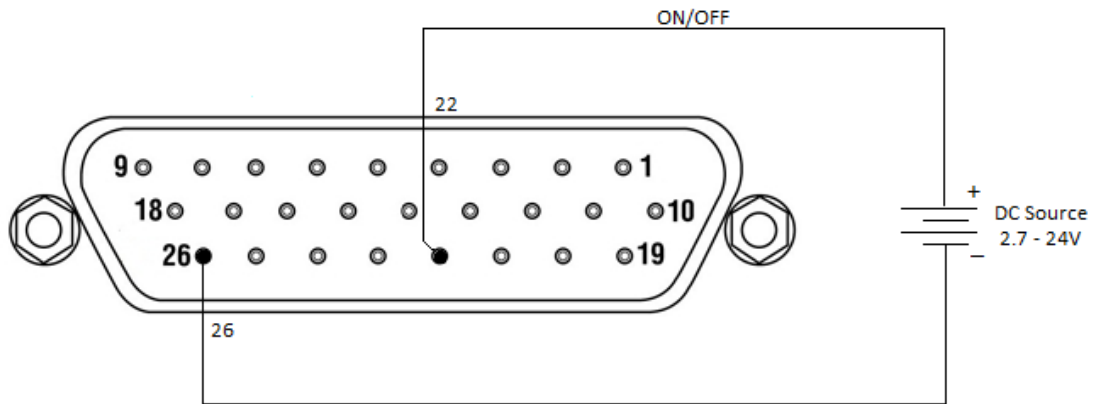

Figure 4-9: Remote Output On/Off Using DC Source Channel 3

4.4 Trigger Functions

The Trigger IN provides functionality of external hardware triggering for sequencing and ramping of voltage and current in each channel individually. Applying input signal of TTL active-high (2.7V to 24V) at between TRIG_IN and RTN terminal. This will trigger the configured function (Sequence or Ramp) in the power supply.

Trigger OUT provides functionality to identify the change in the channel output. Output signal active-low of synchronization pulse for 10 ms would be generated at TRIG_OUT terminal, when a change occurs in the channel output.

The Trigger IN and Trigger OUT functions explained with respect to Ramp function. Power Supply Front Panel Ramp menu allows to configure and execute ramp only for a selected channel at a time. Asterion DC Multioutput ASA Series power supply provides following Ramp functions:

- Voltage Ramp
- Current Ramp

4.4.1 Voltage Ramp

Voltage Ramp could be generated by applying active high signal between TRIGGER IN and Signal return terminal of Remote External User interface connector (refer Figure 4-1 and Table 4-1 for pinout details) with a programmable Dwell, Start and End Voltage set points. Dwell time could be set to 1 ms minimum and 9999 s maximum. Parameters can be programmed through front panel display (refer section 3.4.7.1) or using SCPI commands for programming instruction refer Programming manual of Asterion DC multioutput (M330517-01).

Apply TTL active-high voltage signal on pin 1 (Trig1_IN) and return pin 8 of DB26 external interface control connector. This will trigger the voltage ramp of channel 1; refer Figure 4-10.

Apply TTL active-high voltage signal on pin 10 (Trig2_IN) and return pin 17 of DB26 external interface control connector. This will trigger the voltage ramp of channel 2; refer Figure 4-11.

Apply TTL active-high voltage signal on pin 19 (Trig3_IN) and return pin 26 of DB26 external interface control connector. This will trigger the voltage ramp of channel 3; Refer Figure 4-12.

4.4.2 Current Ramp

Current Ramp could be generated by applying active high signal between TRIGGER IN and Signal return terminal of Remote External User interface connector (refer Figure 4-1 and Table 4-1 for pinout details) with a programmable dwell Time, Start and End Current set points. dwell Time could be set to 1 ms minimum and 9999 s maximum. Parameters can be programmed through front panel display (refer section 3.4.7.1) or using SCPI commands for programming instruction refer Programming manual of Asterion DC multioutput (M330517-01).

Apply TTL active-high voltage signal on pin 1 (Trig1_IN) and return pin 8 of DB26 external interface control connector. This will trigger the current ramp for channel 1; refer Figure 4-10.

Apply TTL active-high voltage signal on pin 10 (Trig2_IN) and return pin 17 of DB26 external interface control connector. This will trigger the current ramp for channel 2; refer Figure 4-11.

Apply TTL active-high voltage signal on pin 19 (Trig3_IN) and return pin 26 of DB26 external interface control connector. This will trigger the current ramp for channel 3; Refer Figure 4-12.

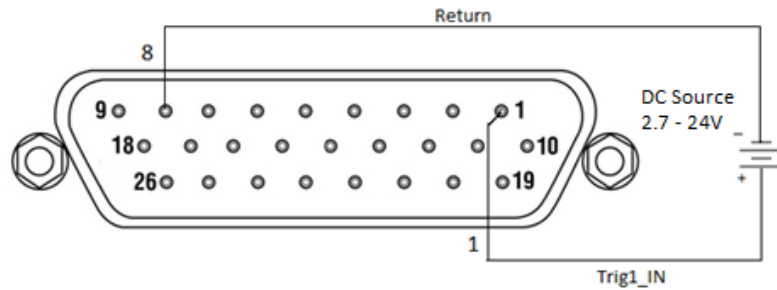

Figure 4-10: Trigger Input for channel 1

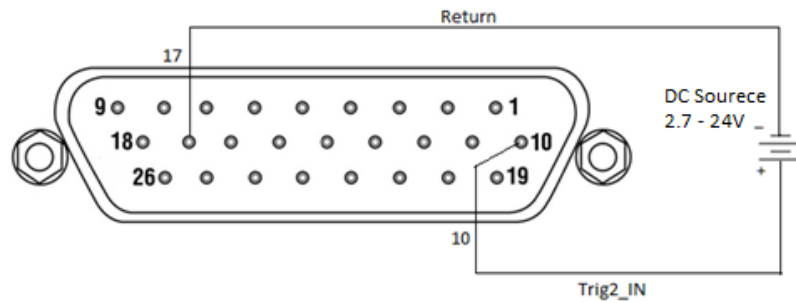

Figure 4-11: Trigger Input for channel 2

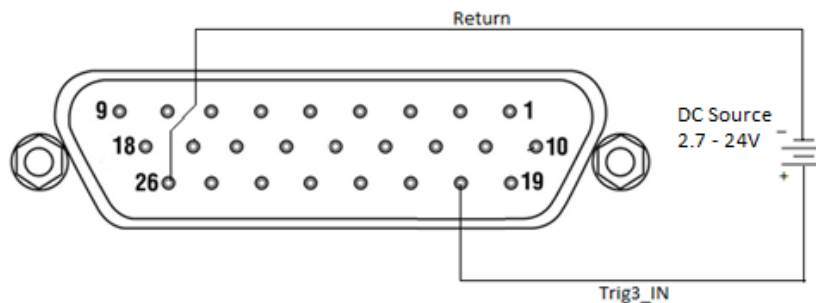

Figure 4-12: Trigger Input for channel 3

4.5 Fault Status

Remote External user interface (26 pin connector) provided with fault Status for each channel of the power supply; refer Table 4-1 for pin out details. an output signal with High state (3 to 30V) indicates that the power supply is in fault condition and Low state indicates it is in no fault condition. Fault status output signal could be monitored on CH-FAULT-STATUS pin out; refer Figure 4-13, Figure 4-14 and Figure 4-15 for the respective channels.

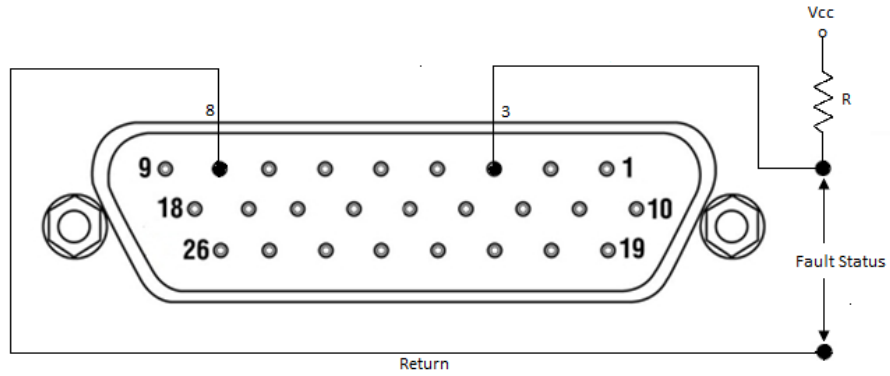

Figure 4-13: Fault Status Channel 1

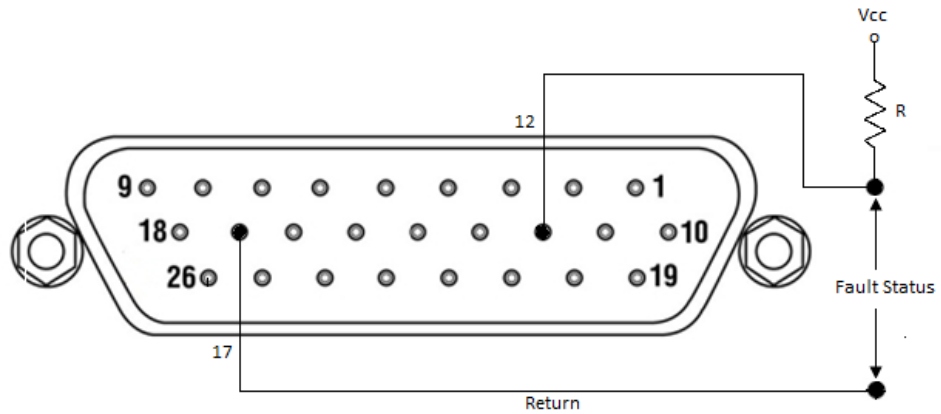

Figure 4-14: Fault Status Channel 2

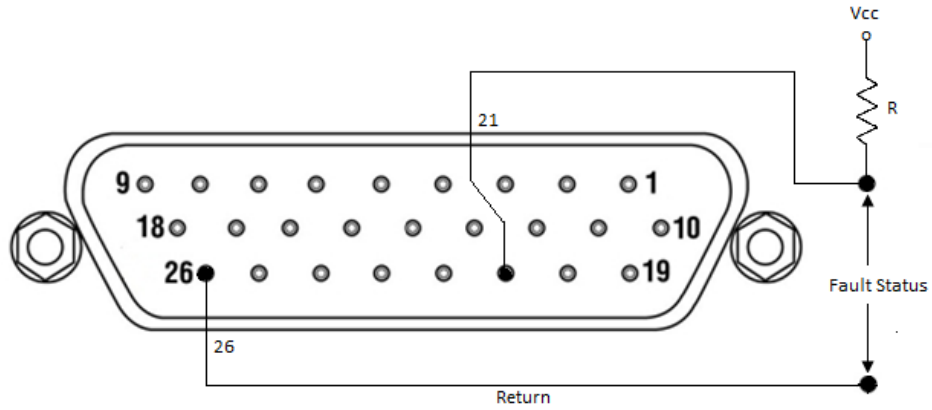

Figure 4-15: Fault status Channel 3

4.6 Regulation Mode Status

Remote External user interface (26 pin connector) provided with regulation mode status outputs for each channel; refer Table 4-1 for pin out details. an output signal with low state indicates that the channel output is in Constant Voltage (CV) mode and high state (minimum 3V to maximum 30V) indicates that the channel output is in Constant Current (CC) mode. Mode can be monitored on respective channel CH-CC/CV-STATUS pin outs; refer Figure 4-16, Figure 4-17 and Figure 4-18 for the pin numbers.

Open collector transistor output, Collector is connected to the CH-CC/CV-STATUS pin of 26-pin connector. Emitter point of transistor is connected to common return pin of the interface connector.

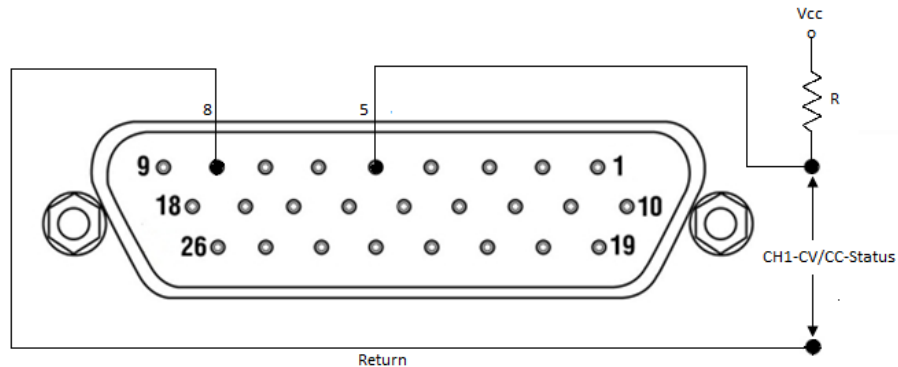

Figure 4-16: Regulation mode status channel 1

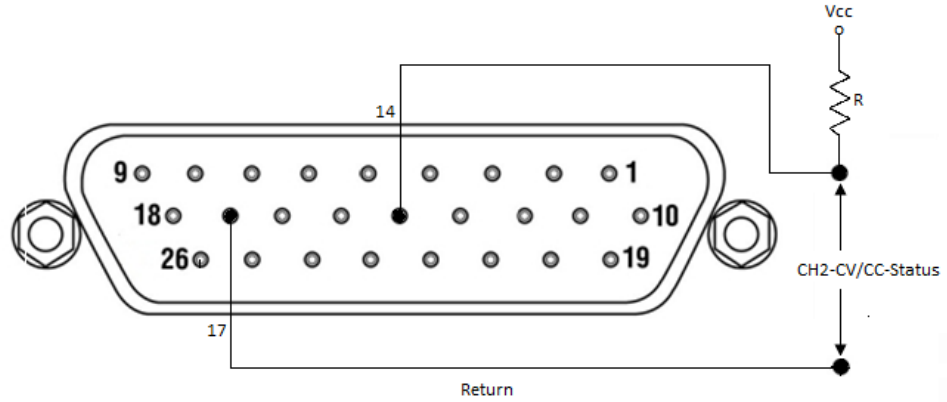

Figure 4-17: Regulation mode status channel 2

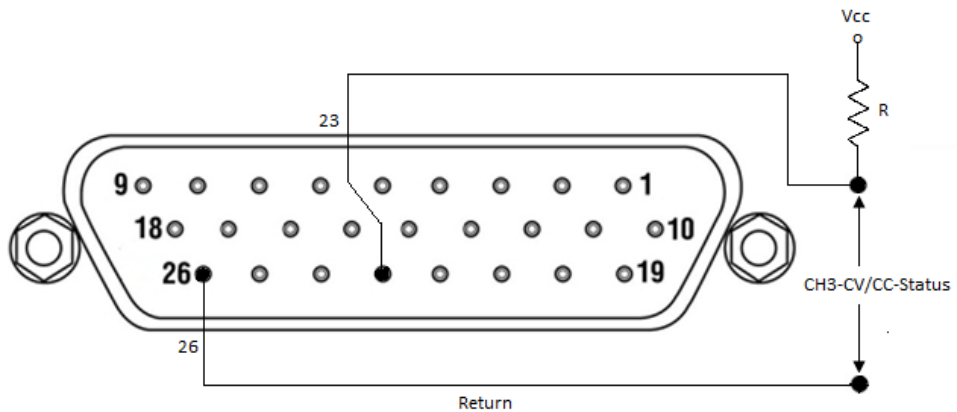

Figure 4-18: Regulation mode status channel 3

4.7 Output ON/OFF Status

Remote External user interface (26 pin connector) provided with Output ON/OFF Status for each channel of the power supply; refer Table 4-1 for pin out details. an output signal with High state (3 to 30V) indicates that the Output of power supply is enabled, and Low state indicates that the output of power supply is disabled. Output status signal can be monitored on CH-OUTPUT- ON/OFF-STATUS pins; refer Figure 4-19, Figure 4-20 and Figure 4-21 for the respective pin out numbers.

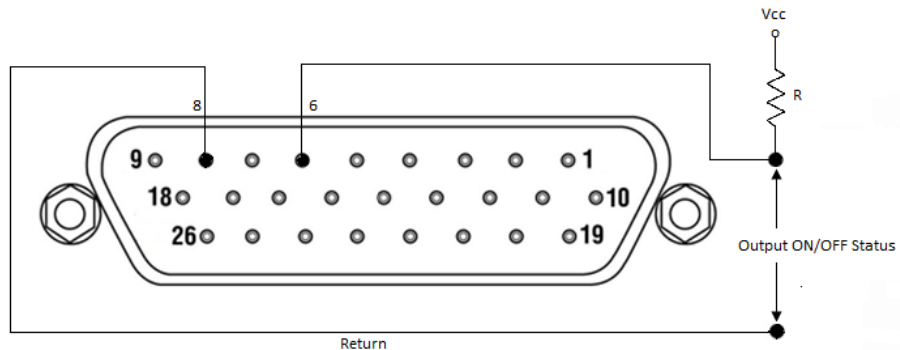

Figure 4-19: Output ON/OFF Status channel 1

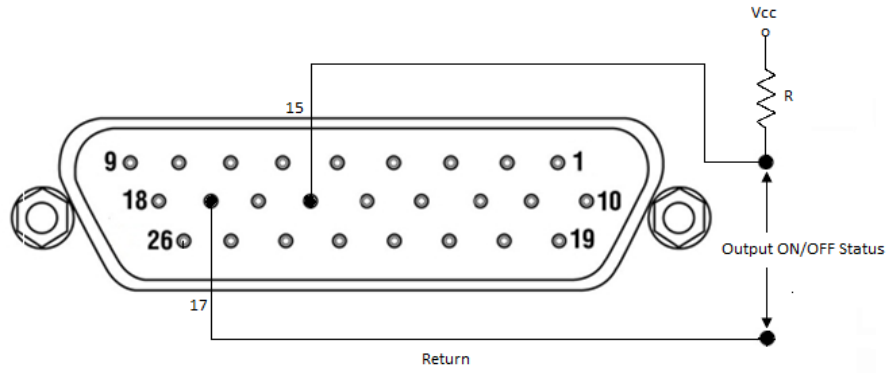

Figure 4-20: Output ON/OFF Status channel 2

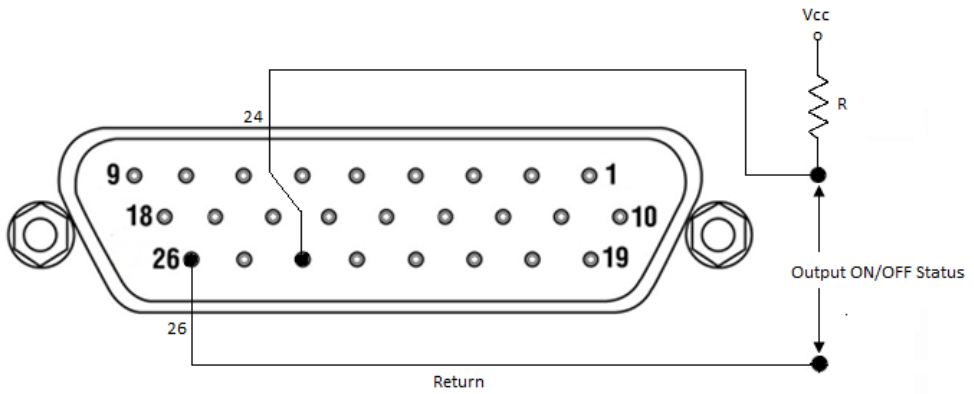

Figure 4-21: Output ON/OFF Status channel 3

5

REMOTE ANALOG PROGRAMMING INTERFACE CONTROL

5.1 Introduction

The Asterion DC Multioutput ASA Series power supply is also provided with optional isolated Analog programming interface. This feature can be supplied based on user demand. Each channel Analog Programming interface Control connector on the rear panel allows the unit to be configured for different operating configurations. Remote analog programming inputs of voltage and current, monitor outputs of voltage and current and they are isolated from channel power outputs. Refer to Figure 5-1 for the connector pin-out diagram and Table 5-1 for connector pin-out details.

The setup and operating requirements of each configuration are provided in Sections 5.3 and 5.4.

The Asterion DC Multioutput ASA Series power supply also has the capability of providing summing of remote analog input with the set values on the front panel (or programmed values via the digital interface) for voltage and current. This capability provides a means to modulate a set value with the signal on the voltage, current analog input. If the user only desires to control the unit with the analog input, all the front panel values (V/I) or digital settings should be set to zero.

5.2 Remote Analog Isolated Interface Control

The Remote Analog Isolated Interface control uses the Analog Control connectors as the standard interface. This option fully isolates remote control signals. These control signals are isolated from common ground. Control ground is isolated from output power (output negative terminal), which protects against potential damage from systems with high electrical noise or large ground loop currents.

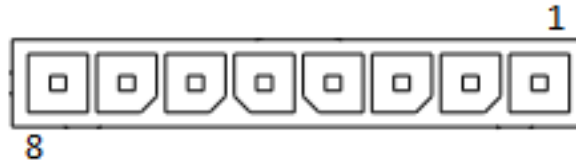



Figure 5-1: Analog Control connector

Pin	Signals	Type	Description
1	VPRG-VSOUR	ANALOG INPUT	<p>Remote control input for voltage programming using a voltage source connected between this pin 1 and 3 signal return.</p> <p>Signal return: Pin 3</p> <p>Range: Full scale Voltage could be set by the user from 5V to 10V.</p> <p>Input impedance: 20 kΩ, typical</p>
2	VPRG-ISOUR	ANALOG INPUT	<p>Remote control input for voltage programming using a resistance connected between this pin and signal return. Current Source of 1 mA is internally connected to this pin to enable resistance programming.</p> <p>Signal return: Pin 3</p> <p>Range: Full scale Voltage could be set by the user from 5kΩ to 10kΩ.</p> <p>Note: Do not exceed resistance of maximum 10kΩ</p>
3	PRG-RTN	PROGRAMMING RETURN	<p>Return for Pin 1 and 2.</p> <p>Pin 3 – PRG-RTN is shorted with Pin 6 – MON-RTN internal to the power supply.</p>
4	IPRG-VSOUR	ANALOG INPUT	<p>Remote control input for current programming using a voltage source connected between this pin and signal return.</p> <p>Signal return: Pin 3</p> <p>Range: Full scale Current could be set by the user from 5V to 10V.</p> <p>Input impedance: 20 kΩ, typical</p>
5	IPRG-ISOUR	ANALOG INPUT	<p>Remote control input for current programming using a resistance connected between this pin and signal return. Current Source of 1 mA is connected to this pin from the power supply to enable resistance programming.</p> <p>Signal return: Pin 3</p> <p>Range: Full scale Current could be set by the user from 5kΩ to 10kΩ.</p> <p>Note: Do not exceed resistance of maximum 10kΩ</p>

6	MON-RTN	MONITOR RETURN	Return for Pin 7 and 8. Pin 3 – PRG-RTN is shorted with Pin 6 – MON-RTN internal to the power supply.
7	VMON	ANALOG OUTPUT	Monitor signal for output voltage Signal return: Pin 6 Range: 0V to 10V corresponds to 0-100% full-scale output. Output impedance: 100 Ω, typical Minimum recommended Load: 100kΩ, typical Maximum Load: 20kΩ
8	IMON	ANALOG OUTPUT	Monitor signal for output current Signal return: Pin 6 Range: 0V to 10V corresponds to 0-100% full-scale output. Output impedance: 100Ω, typical Minimum recommended Load: 100kΩ, typical Maximum Load: 20Ω

Table 5-1: Analog Programming Connector, Designations and Functions

The pinout function mentioned in Table 5-1 is identical for each channel connectors. To program desired channel corresponding analog channel connector to be utilized.

	<p>CAUTION! Return signal of all the three channels are shorted internal to the power supply. Applying a voltage potential between the channel return signal of the individual channels would damage the power supply.</p>
	<p>CAUTION! Analog programming interface signals are isolated from negative output terminal; Isolation voltage is rated for ±600 VRMS maximum; operation of Isolated Analog Interface signals should be at SELV safety voltage conditions to chassis ground.</p>

5.3 Remote Current Programming

Remote current programming can be summed with Full Scale value on the front panel or digital setting for individual channels. Remote current programming is used for applications that require the output current be programmed (controlled) from a remote instrument. An external resistance or external voltage source can be used as a programming device. When using remote current programming, a shielded, twisted-pair cable is recommended to prevent noise interference to programming signals.

Remote current programming configurations given below is with reference to channel 1. The same configuration is to be followed for the other two channels (channel 2 and channel 3). i.e., wherever channel 1 is stated it should be replaced and followed for the selected channel (channel 2 or channel 3).

5.3.1 Remote Current Programming by Resistance

Programs the output current of the supply by external resistive reference source. Refer Section 3.4.9.3 to configure the power supply to program output current by external reference source using front panel screen or refer programming manual P\N: M330517-01.

Power supply configurations to program output current by resistance:

1. Set the Current Reference Mode as external (EXT) from the front panel current ref mode screen for selected channel; refer Figure 5-2, this allows the power supply output current to be programmed from external source for selected channel.

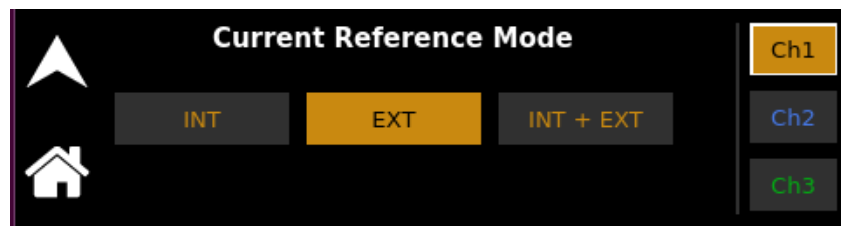

Figure 5-2: Current Reference Mode

2. Set the Current Reference Source as resistive from the front Panel (refer to Figure 5-3) for channel 1. With the settings made, power supply's output current could be programmed using only by external resistance.

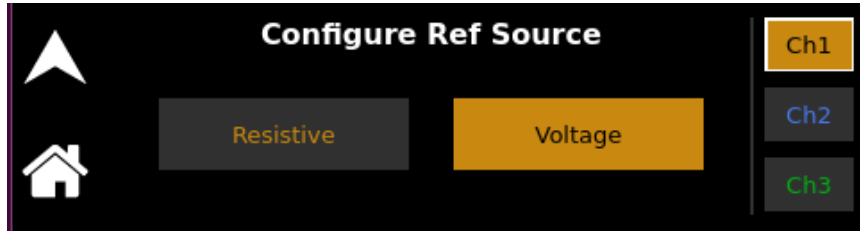

Figure 5-3: Configure Ref Source

3. Set the Full-Scale value from the front panel. (Refer Figure 5-4) for channel 1.

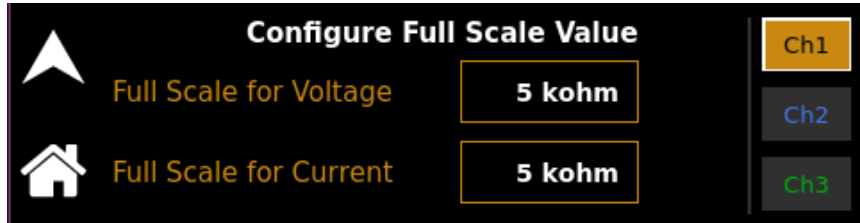

Figure 5-4: Configure Full Scale Value

4. Connect a resistance across the IPRG_ISOUR pin and PRG_RTN pin of channel 1 analog programming interface connector (refer Figure 5-6). This will program the output current for selected channel of the power supply. measurements of the output current would be displayed in measurements screen; refer Figure 5-5.



Figure 5-5: Output Measurement screen

The resistance-programming default coefficient for output current is (100% rated output current) / 10 kΩ, with input at Pin 5 (IPRG_ISOUR) and return to Pin 3 (PRG_RTN). An internal current source, factory-set at 1 mA, from Pin 5 is utilized to drive the resistance. This produces a transfer function for output current, as follows:

$$I_{out} = R * ((100\% \text{ rated output current}) / 10 \text{ k}\Omega), \text{ with } R \text{ in kilo ohms.}$$

Full Scale current programming resistance can be modified from default 5kOhms to any other value, from 5 kΩ to 10 kΩ. Refer to Section 3.4.9.3. Then the transfer function for output current, as follows:

$$I_{out} = R * ((100\% \text{ rated output current}) / \text{FSC k}\Omega), \text{ with } R \text{ in kilo ohms.}$$

Where FSC k Ω is Full Scale current programming resistance from the front panel reference source configuration screen or from the SCPI Command,
 SOUR1:VOLT:PROG:FSC <value>

If multiple switches or relays are used to select resistors to program different current levels, make-before-break contacts are recommended.

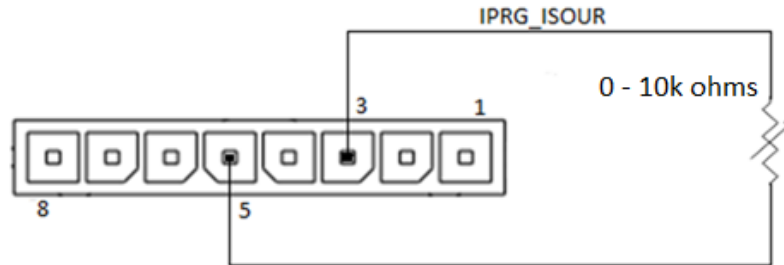

Figure 5-6: Remote Current Programming Using Resistance

Example: program the output current to 80% of rated output current value using 8 k Ω resistance.

- Navigate to Current Ref Mode menu,
- Select Channel and set EXT; refer Figure 5-2.
- Navigate to Configure Reference Source menu,
- Select Channel and set reference source as Resistive; refer Figure 5-3.
- Navigate to Configure Full Scale Value menu,
- Select Channel and Set Full scale value for Current into 10 k Ω (100% of FSC); refer Figure 5-4.
- Connect an 8 k Ω (80% of FSC) resistance across the respective channel analog programming connector between IPRG_ISOURL and PRG_RTIN terminal; refer Figure 5-6.
- Verify the output current from the measurement screen for respective channel; refer Figure 5-5.

5.3.2 Remote Current Programming by Voltage Source

Programs the output current of the supply by external voltage reference source. Refer Section 3.4.9.3 to configure the power supply to program output current by external reference source using front panel screen or refer programming manual P\N: M330517-01.

Power supply configurations to program output current by voltage source:

1. Set the Current Reference Mode as external (EXT) from the front panel current ref mode screen for selected channel; refer Figure 5-2, this allows the supply output current to be programmed from external source for selected channel.

2. Set the Current Reference Source as voltage from the front Panel (refer to refer to Figure 5-3) for selected channel. With the settings made, power supply output current could be programed using only by external voltage source.
3. Set the Full-Scale value from the front panel Screen (Refer Figure 5-7) for selected channel.
4. Connect a DC voltage source cross the IPRG_VSOUR pin and PRG_RTN pin of the channel 1 analog programming interface connector (refer Figure 5-7). This will program output current for selected channel of the supply.

The Full-Scale voltage value can be modified to any voltage between 5V to 10V from front panel screen or by the digital interface SCPI Command, refer to Section 3.4.9.3. Default FSC voltage value is 10V, where 10V corresponds to 100% output current. The corresponding voltage-programming coefficients for output current are (100% rated output current) / FSC VDC. This produces transfer functions for output current, as follows:

$I_{out} = V_{dc} * (100\% \text{ rated output current}) / 10 \text{ VDC}$, with V_{dc} in volts, or

$I_{out} = V_{dc} * (100\% \text{ rated output current}) / \text{FSC VDC}$, with V_{dc} in volts.

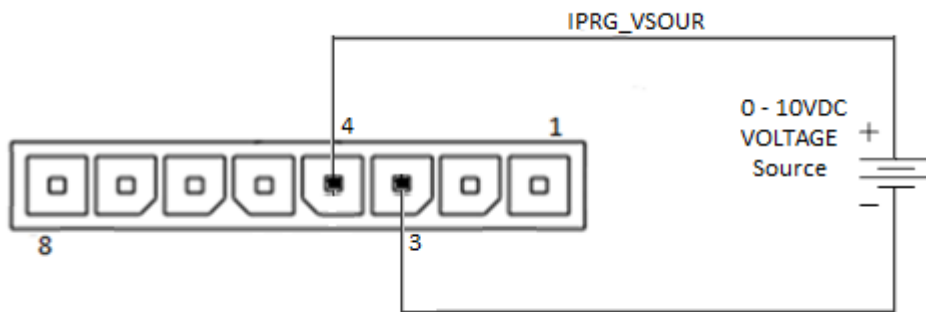

Figure 5-7: Remote Current Programming Using Voltage Source

Example: program the output current to 85% of rated output current using voltage source.

- Navigate to Current Ref Mode menu,
- Select Channel and set EXT Mode; refer Figure 5-2
- Navigate to Configure Reference Source menu,
- Select Channel and set reference source as Voltage; refer Figure 5-3.
- Navigate to Configure Full Scale Value menu,
- Select Channel and Set Full scale value for Voltage into 10V (100% of FSC); refer Figure 5-4.

- Connect an DC voltage source across the respective channel analog programming connector between IPRG_VSOUR and PRG_RTN terminal and apply 8.5V (85% of FSC); refer .
- Verify the output current from the measurement screen for respective channel; refer Figure 5-5.

5.4 Remote Voltage Programming

Remote voltage programming is summed with Full Scale value on the front panel or digital setting for individual channels. Remote voltage programming configuration is used for applications that require the output voltage be programmed (controlled) from a remote instrument. An external resistance or external voltage source can be used as a programming device. When using remote voltage programming, a shielded, twisted-pair cable is recommended to prevent noise interference to programming signals.

Remote Voltage Programming configurations given below is with reference to channel 1. The same configuration is to be followed for the other two channels (channel 2 and channel 3). i.e. wherever channel 1 is stated it should be replaced and followed for the selected channel (channel 2 or channel 3).

5.4.1 Remote Voltage Programming by Resistance

Programs the output voltage of the supply by external resistive reference source. Refer Section 3.4.9.3 to configure the power supply to program output voltage by external reference source using front panel screen or refer programming manual P\N: M330517-01.

Power supply configurations to program output voltage by resistance:

1. Set the Voltage Reference Mode as external (EXT) from the front panel voltage ref mode screen for selected channel; refer Figure 5-8, this allows the supply output voltage to be programed form external source for selected channel.

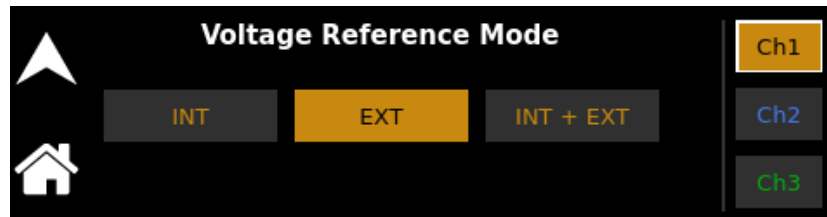

Figure 5-8: Voltage Reference Mode

2. Set the Voltage Reference Source as resistive from the front Panel (refer to Figure 5-3) for selected channel. With the settings made, power supply output voltage could be programed using only by external resistance.

3. Set the Full-Scale value from the front panel screen (Refer Figure 5-4) for selected channel.
4. Connect a resistance across the VPRG_ISOURL pin and PRG_RTIN pin of the selected channel analog programming interface connector (refer Figure 5-9). This will program output voltage for selected channel of the supply.

The resistance-programming default coefficient for output voltage is (100% rated output voltage) / 10kΩ, with input at Pin 2 (VPRG_ISOURL) and return to Pin 3 (PRG_RTIN). An internal current source, factory-set at 1 mA. This produces a transfer function for output voltage, as follows:

$$V_{out} = R * (100\% \text{ rated output voltage}) / 10k\Omega, \text{ with } R \text{ in kilo ohms.}$$

Full Scale voltage programming resistance can be modified from default 5kOhms to any other value, from 5kΩ to 10kΩ, refer to Section 3.4.9.3. Then the transfer function for output voltage, as follows:

$$V_{out} = R * (100\% \text{ rated output voltage}) / FSC \text{ k}\Omega, \text{ with } R \text{ in kilo ohms.}$$

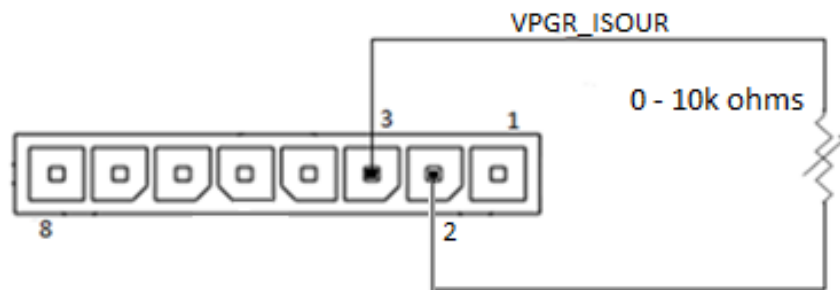

Figure 5-9: Remote Voltage Programming Using Resistance

5.4.2 Remote Voltage Programming by Voltage Source

Programs the output voltage of the supply by external voltage reference source. Refer Section 3.4.9.3 to configure the power supply to program output voltage by external reference source using front panel screen or refer programming manual P\N: M330517-01.

Power supply configurations to program output voltage by voltage source:

1. Set the Voltage Reference Mode as external (EXT) from the front panel Voltage ref mode screen for selected channel; refer Figure 5-8, this allows the supply output voltage to be programmed from external source for selected channel.
2. Set the Voltage Reference Source as voltage from the front Panel (refer to Figure 5-3) for selected channel. With the settings made, power supply output voltage could be programmed using only by external voltage source.

3. Set the Full Scale value from the front panel screen (Refer Figure 5-4) for selected channel.
4. Connect a DC voltage source across the VPRG_VSOUR pin and PRG_RTN pin of the channel 1 analog programming interface connector (refer Figure 5-10). This will program output voltage for selected channel of the supply.

The DC voltage source is connected between Pin 1 (VPRG_VSOUR) and the return Pin 3 (PRG_RTN) and Analog Reference source is selected as Voltage from the front Panel. Refer to Figure 5-10.

The Full-Scale voltage value can be modified to any voltage between 5V to 10V from front panel screen, refer to Section 3.4.9.3. Default FSC voltage value is 10V, where 10V corresponds to 100% output voltage. The corresponding voltage-programming coefficients for output voltage are (100% rated output voltage) / FSC VDC. This produces transfer functions for output voltage, as follows:

$V_{out} = V_{dc} * (100\% \text{ rated output voltage}) / 10 \text{ VDC}$, with V_{dc} in volts, or

$V_{out} = V_{dc} * (100\% \text{ rated output voltage}) / \text{FSC VDC}$, with V_{dc} in volts.

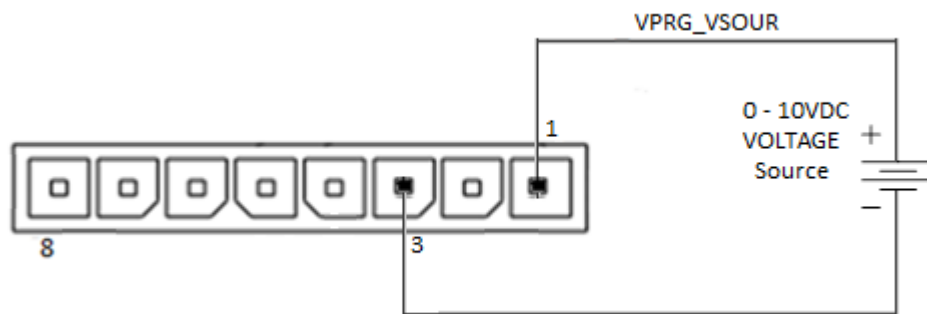

Figure 5-10: Remote Voltage Programming Using 0-10 VDC Source

Example: Program Full Scale Value of Voltage to 8V and program output voltage into 60% of rated output voltage using voltage source:

- Navigate to Voltage Ref Mode menu,
- Select Channel and set EXT Mode; refer Figure 5-8.
- Navigate to Configure Reference Source menu,
- Select Channel and set reference source as Resistive; refer Figure 5-3.
- Navigate to Configure Full Scale Value menu,
- Select Channel and set Full Scale Value for Voltage into 8V (100% of FSC); refer Figure 5-4.
- Connect a DC voltage source across the respective channel analog programming connector between VPRG_VSOUR and PRG_RTN terminal and apply 4.8V; refer Figure 5-10.
- Verify the output Voltage from the measurement screen for respective channel; refer Figure 5-5.

5.5 Voltage Monitor (VMON)

Voltage Monitor provides functionality to monitor the scaled down output voltage of the power supply of each channel; refer Figure 5-1 and Table 5-1 for pin out details. Scaled down Output voltage could be monitored at VMON terminal of analog programming connector. Measurement of output voltage from 0 to 100% of full scale rated output corresponds to 0 to 10V.

Default Full Scale Voltage Monitor Output is 10V. Same can be changed from 5V to 10 V by issuing following SCPI command. For example, to set to 5V as full scale for voltage monitoring send below command:

SOUR<n>:VOLT:MON:FSC 5

NOTE: The data format <n> represents channel number (1,2 and 3).

5.6 Current Monitor (IMON)

Current Monitor provides functionality to monitor the scaled down output current of the power supply of each channel; refer Figure 5-1 and Table 5-1 for pin out details. Scaled down Output current could be monitored at IMON terminal of analog programming connector. Measurement of output current 0 to 100% of full-scale rated output corresponds to 0 to 10V.

Default Full Scale Current Monitor Output is 10V. Same can be changed from 5V to 10 V by issuing following SCPI command. For example, to set to 5V as full scale for current monitoring send below command:

SOUR<n>:CURR:MON:FSC 5

NOTE: The data format <n> represents channel number (1,2 and 3).

CALIBRATION AND VERIFICATION

6.1 Introduction

This section provides calibration and verification procedures for the Asterion DC Multioutput ASA Series power supplies.

6.1.1 Calibration and Verification Cycle

Annual calibration and verification are recommended. Calibrate only as needed.

6.1.2 Digital programming and readback calibration

Refer to the Asterion DC Multioutput Series programming manual for calibration of display readback and remote digital programming.

6.1.3 Analog control interface calibration (Standard and Isolated analog interface)

Refer to the Asterion DC Multioutput Series programming manual for calibration of remote analog programming.

7 MAINTENANCE

7.1 Introduction

This chapter contains preventive maintenance information for the Asterion DC Multioutput ASA Series power supplies.



WARNING!

All maintenance that requires removal of the cover of the unit should only be done by properly trained and qualified personnel. Hazardous voltages exist inside the unit. Disconnect the supply from the AC mains input before performing any maintenance. Service, fuse verification, and connecting of wiring to the chassis must be accomplished at least 5 *minutes* after AC input power has been removed with an external disconnect switch. Do not touch any circuits and/or terminals that are energized.

7.2 Preventive Maintenance



WARNING!

The OFF position of the front panel power switch does not remove AC input from internal circuits or input terminal blocks. Disconnect external AC input before servicing unit.



CAUTION!

For safe and continued operation of the Asterion DC Multioutput ASA Series, always operate the unit in a temperature and humidity controlled, indoor area. Exposure to conductive contaminants or corrosive compounds/gases that could be ingested into the chassis could result in internal damage. Keep the rear and sides of the unit free of obstructions to ensure proper ventilation.

No routine maintenance on the Asterion DC Multioutput ASA Series is required, aside from periodic cleaning of the unit and inspection, as required by the environmental operating conditions:

- Once a unit is removed from service, vacuum all air vents, including the front panel grill.

- Clean the exterior with a mild solution of detergent and water. Apply the solution onto a soft cloth, not directly to the surface of the unit. To prevent damage to materials, do not use aromatic hydrocarbons or chlorinated solvents for cleaning.
- Check external connections for integrity of insulation, loose contacts, and proper torque.
- If there is any evidence of short-circuits or arcing, overheating, or corrosion, contact the factory for recommended service.