



P/N M330000-02

Revision G

Mar 2026

Copyright © 2019

AMETEK Programmable Power

All rights reserved

California Instruments

Asterion Series

AC/DC Power Source

2U Models

User Manual

About AMETEK

AMETEK Programmable Power, Inc., a Business Unit of AMETEK, Inc., is a global leader in the design and manufacture of precision, programmable power supplies for R&D, test and measurement, process control, power bus simulation and power conditioning applications across diverse industrial segments. From bench top supplies to rack mounted industrial power subsystems, AMETEK Programmable Power is the proud manufacturer of Elgar, Sorensen, California Instruments, Amrel brand power supplies.

AMETEK, Inc. is a leading global manufacturer of electronic instruments and electromechanical devices with annualized sales of \$5 billion. The Company has over 18,000 colleagues working at nearly 180 manufacturing facilities and nearly 150 sales and service centers in the United States and 30 other countries around the world.

Trademarks

AMETEK is a registered trademark of AMETEK, Inc. California Instruments is a trademark owned by AMETEK, Inc. Other trademarks, registered trademarks, and product names are the property of their respective owners and are used herein for identification purposes only.

Notice of Copyright

Asterion Series User Manual © 2019 AMETEK Programmable Power, Inc. All rights reserved.

Exclusion for Documentation

UNLESS SPECIFICALLY AGREED IN WRITING, AMETEK PROGRAMMABLE POWER, INC. (AMETEK):

- (a) MAKES NO WARRANTY AS TO THE ACCURACY, SUFFICIENCY OR SUITABILITY OF ANY TECHNICAL OR OTHER INFORMATION PROVIDED IN ITS MANUALS OR OTHER DOCUMENTATION.
- (b) ASSUMES NO RESPONSIBILITY OR LIABILITY FOR LOSSES, DAMAGES, COSTS OR EXPENSES, WHETHER SPECIAL, DIRECT, INDIRECT, CONSEQUENTIAL OR INCIDENTAL, WHICH MIGHT ARISE OUT OF THE USE OF SUCH INFORMATION. THE USE OF SUCH INFORMATION WILL BE ENTIRELY AT THE USER'S RISK, AND
- (c) GIVES NOTIFICATION THAT, IF THIS MANUAL IS IN ANY LANGUAGE OTHER THAN ENGLISH, ALTHOUGH STEPS HAVE BEEN TAKEN TO MAINTAIN THE ACCURACY OF THE TRANSLATION, THE ACCURACY CANNOT BE GUARANTEED. APPROVED AMETEK CONTENT IS WITHIN THE ENGLISH LANGUAGE VERSION, WHICH IS POSTED AT WWW.PROGRAMMABLEPOWER.COM.

Part Number

M330000-02

Revision and Date

Revision G, Mar 2026

Contact Information

Telephone: 800 733 5427 (toll free in North America)

858 450 0085 (direct)

Fax : 858 458 0267



Email : sales.ppd@ametek.com

repair.ppd@ametek.com

Web: www.programmablepower.com

Important Safety Instructions

Before applying power to the system, verify that your product is configured properly for your particular application.

 WARNING	<p>Hazardous voltages may be present when covers are removed. Qualified personnel must use extreme caution when servicing this equipment. Circuit boards, test points, and output voltages also may be floating at a high voltage relative to chassis ground.</p>
 WARNING	<p>The equipment used contains ESD sensitive parts. When installing equipment, follow ESD Safety Procedures. Electrostatic discharges might cause damage to the equipment.</p>

Only *qualified personnel*, who deal with attendant hazards in power supplies, are allowed to perform installation and servicing.

Ensure that the AC input power line ground is connected properly to the unit safety ground chassis. Similarly, other AC power ground lines, including those to application and maintenance equipment, *must* be grounded properly for both personnel safety and equipment protection.













Always ensure that facility AC input power is de-energized prior to connecting or disconnecting any cable.

In normal operation, the operator does not have access to hazardous voltages within the chassis. However, depending on the user’s application configuration, **HIGH VOLTAGES HAZARDOUS TO HUMAN SAFETY** may be normally generated on the output terminals. The customer/user must ensure that the output power lines are labeled properly as to the safety hazards and that any inadvertent contact with hazardous voltages is prevented.

Guard against risks of electrical shock during open cover checks by not touching any portion of the electrical circuits. Even when power is off, capacitors may retain an electrical charge. Use safety glasses and protective clothing during open cover checks to avoid personal injury by any sudden component failure.

AMETEK Programmable Power Inc., San Diego, California, USA, or any of the subsidiary sales organizations, cannot accept any responsibility for personnel, material or inconsequential injury, loss or damage that results from improper use of the equipment and accessories.

Safety Symbols

 WARNING Risk of Electrical Shock	 CAUTION Refer to Accompanying Documents
 Off (Supply)	 Direct Current (DC)
 Standby (Supply)	 Alternating Current (AC)
 On (Supply)	 Three-Phase Alternating Current
 Protective Conductor Terminal	 Earth (Ground) Terminal
 Fuse	 Chassis Ground

Product: Asterion Series Power Source

Warranty Period: 1 Year

Warranty Terms

AMETEK Programmable Power, Inc. (AMETEK), provides this written warranty covering the Product stated above, and if the Buyer discovers and notifies AMETEK in writing of any defect in material or workmanship within the applicable warranty period stated above, then AMETEK may, at its option: repair or replace the Product; or issue a credit note for the defective Product; or provide the Buyer with replacement parts for the Product.

The Buyer will, at its expense, return the defective Product or parts thereof to AMETEK in accordance with the return procedure specified below. AMETEK will, at its expense, deliver the repaired or replaced Product or parts to the Buyer. Any warranty of AMETEK will not apply if the Buyer is in default under the Purchase Order Agreement or where the Product, or any part thereof, is as follows:

- damaged by misuse, accident, negligence or failure to maintain the same as specified or required by AMETEK.
- damaged by modifications, alterations or attachments thereto which are not authorized by AMETEK.
- installed or operated contrary to the instructions of AMETEK.
- opened, modified, or disassembled in any way without consent from AMETEK.
- used in combination with items, articles or materials not authorized by AMETEK.

The Buyer may not assert any claim that the Products are not in conformity with any warranty until the Buyer has made all payments to AMETEK provided for in the Purchase Order Agreement.

Product Return Procedure

Request a Return Material Authorization (RMA) number from the repair facility (**must be done in the country in which it was purchased**):

- **In the USA**, contact the AMETEK Customer Service Department prior to the return of the product to AMETEK for repair:
Telephone: 800-733-5427, ext. 2295 or ext. 2463 (toll free North America)
858-450-0085, ext. 2295 or ext. 2463 (direct)
- **Outside the United States**, contact the nearest Authorized Service Centre (ASC). A full listing can be found either through your local distributor, or on our website, www.programmablepower.com, by tapping Support button or going to the Service Centres tab.

When requesting an RMA, have the following information ready:

- Model number
- Serial number
- Description of the problem

NOTE: Unauthorized returns will not be accepted and will be returned at the shipper's expense.

NOTE: A returned product found upon inspection by AMETEK to be in specification is subject to an evaluation fee and applicable freight charges.

Table of Contents

1. Introduction	13
1.1 General Description	13
1.2 Asterion Series Models	14
2. Specifications	15
2.1 Electrical Characteristics	15
2.1.1 AC/DC Output Specifications	15
2.1.2 iX2™ Constant-Power Mode Output Characteristic	18
2.1.3 AC Input Specifications	19
2.1.4 AC Output Measurements	20
2.1.5 DC Output Measurements	21
2.1.6 Harmonics Measurements	22
2.1.7 Protection Function Characteristics	22
2.2 Regulatory Agency Compliance	23
2.3 Environmental Specifications	23
2.4 Mechanical Specifications	24
2.5 Remote Control Digital Interface Characteristics	24
2.6 Remote Control Analog/Digital Signal Characteristics	25
2.7 Operational Characteristics	26
2.8 Front Panel Controls/Indicators	27
2.9 Rear Panel Connectors	28
2.10 Firmware/Software Options	29
3. Installation	31
3.1 Unpacking	31
3.1.1 Contents of Shipment	31
3.2 Mechanical Installation	32
3.2.1 Brackets and Handles	33
3.2.2 Rack mounting	34
3.3 Outline Drawings	36
3.4 Rear Panel Protective Covers	36
3.5 Input/Output Connections	39
3.6 AC Input Connection	40
3.6.1 AC Input Overcurrent Protection	40
3.6.2 AC Input Safety Disconnect Device	40
3.6.3 AC Input Connector	40
3.6.4 1-Phase AC Input Operation	41
3.6.5 3-Phase AC Input Operation	41
3.7 AC/DC Output Connection	42
3.8 Remote Sense Connection	43
3.9 Remote Sense	44
3.10 Noise and Impedance Effects	44
3.11 Wire Gauge Selection	45
3.11.1 Wire Size	45
3.12 Rear Panel User Interface Connectors	47
3.12.1 External Input/Output Control Signal Connector	47
3.12.2 Summary Fault Signal (DFI)	49
3.12.3 Remote Inhibit Signal	50
3.12.4 External Interface Signal Connector	50
3.12.5 Command Monitor and Trigger Output Connectors	51
3.12.6 Clock and Lock Connectors (Option)	51
3.12.7 Master/Auxiliary System Interface Connectors	52
3.12.8 RS-232C Serial Interface Connector	53
3.12.9 USB Interface	54
3.12.10 LAN Interface (Ethernet)	55
3.13 Multiple Chassis System Configurations	56
3.13.1 Multi-Phase System	56
3.13.2 Parallel System	56

4. Operation	57
4.1 Front Panel Operation	57
4.1.1 Front Panel Controls and Indicators, Enhanced 2U Models	59
4.1.2 Front Panel Controls and Indicators, ATE 2U Models	60
4.2 Basic Output Programming.....	61
4.2.1 Front Panel Display Navigation.....	61
4.2.2 Selecting Output Characteristics and Adjusting Parameters.....	61
4.3 Basic Functional Test	62
4.4 Output Power Characteristic.....	64
4.4.1 Front Panel Touch-Screen Display	64
4.4.2 Touch-Screen Numeric Keypad.....	66
4.4.3 Rotary Encoder.....	66
4.5 Front Panel Display Menus.....	68
4.5.1 DASHBOARD Screen Top-Level Menu.....	70
4.5.2 OUTPUT PROGRAM Screen Top Level Menus.....	72
4.5.3 MEASUREMENTS Screen Top-Level Menus.....	77
4.5.4 TRANSIENTS Screen Top-Level Menu.....	83
4.5.5 CONFIGURATION Screen	99
4.5.6 CONTROL INTERFACE Screen.....	108
4.5.7 PROTECTION Screen.....	113
4.5.8 APPLICATIONS Screen	114
4.5.9 SYSTEM SETTINGS Screen.....	115
5. Waveform Management.....	118
5.1 Standard Waveforms.....	118
5.2 Creating Custom Waveforms.....	118
5.2.1 Viewing Custom Waveforms on the Display	119
5.3 RMS Amplitude Restrictions	119
5.4 Frequency Response Restrictions	120
5.5 Transient List Waveforms	120
6. Standard Measurements	122
6.1 Parameter Measurements	122
6.1.1 Accuracy Considerations	123
6.2 Advanced Measurements	123
6.2.1 Harmonic Analysis	123
6.2.2 Acquiring FFT data	123
6.2.3 Analyzing FFT Data.....	124
6.3 Triggering Measurements.....	126
6.3.1 Trigger Mode	126
6.3.2 Trigger source.....	126
6.3.3 Trigger delay.....	127
7. Transient Programming	130
7.1 Using Transient Modes.....	130
7.1.1 Step Transients.....	131
7.1.2 Pulse Transients.....	131
7.1.3 List Transients	132
7.2 Programming Slew Rates	133
7.3 Switching Waveforms in Transient Lists	134
7.4 Saving Transient List Programs.....	135
8. Calibration	136
8.1 Calibration Equipment	136
8.2 Calibration Procedures	136
8.2.1 Preparation for Calibration.....	136
8.2.2 Output Voltage AC Zero Alignment, AC-Mode.....	137
8.2.3 Output Voltage DC Zero Alignment, DC-Mode	137
8.2.4 Output Voltage Gain Initial Alignment, AC-Mode and DC-Mode.....	138
8.2.5 Output Voltage Measurement AC Gain Alignment, AC-Mode.....	139

8.2.6	Output Voltage Measurement DC-Positive Gain Alignment, DC-Mode	139
8.2.7	Output Voltage Measurement DC-Negative Gain Alignment, DC-Mode.....	140
8.2.8	Output Current Measurement AC Low-Range Gain Alignment, AC-Mode	140
8.2.9	Output Current Measurement AC High-Range Gain Alignment, AC-Mode	141
8.2.10	Output Current Measurement AC Low-Range Offset Alignment, AC-Mode	142
8.2.11	Output Current Measurement AC High-Range Offset Alignment, AC-Mode.....	142
8.2.12	Output Current Measurement DC-Positive Low-Range Gain Alignment, DC-Mode	143
8.2.13	Output Current Measurement DC-Positive High-Range Gain Alignment, DC-Mode	143
8.2.14	Output Current Measurement DC-Negative Low-Range Gain Alignment, DC-Mode.....	144
8.2.15	Output Current Measurement DC-Negative High-Range Gain Alignment, DC-Mode	144
8.2.16	Output Current Measurement Low-Range Offset Alignment, DC-Mode	145
8.2.17	Output Current Measurement High-Range Offset Alignment, DC-Mode	146
8.2.18	Output Phase-A Alignment, Output Relative to External SYNC.....	147
8.2.19	Output Phase-A Alignment, Auxiliary Unit Relative to Master Unit (LKS Option Only)	147
8.2.20	Output Phase-B and Phase-C Alignment Relative to Phase-A.....	148
8.2.21	Alignment of External Programming Signal for Output Voltage Waveform/Amplitude	149
8.2.22	Alignment of External Programming Signal for Output Voltage Amplitude, DC Output	150
8.2.23	Alignment of External Programming Signal for Output Voltage Amplitude, AC output	151
8.2.24	Alignment of Inter-harmonics Output (413 Option Only).....	152
9.	Service.....	154
9.1	Cleaning	154
9.2	Basic Troubleshooting.....	154
9.2.1	Excessive Output Voltage	154
9.2.2	Poor Output Voltage Regulation	154
9.2.3	FAULT LED is On.....	154
9.2.4	Distorted Output	155
9.2.5	Unit Shuts Down after Short Interval	155
9.2.6	No Output and Front Panel Display/LEDs are Off.	155
9.2.7	No Output and Front Panel Display/LEDs are On	155
9.2.8	Setting of AC/DC Mode or Voltage Range is Not Accepted	155
9.2.9	Parallel Group Faults When Master Output Switch is Turned On.....	155
10.	Error and Status Messages.....	156
	Index	162

List of Figures

Figure 1-1. Asterion Series Front View, 2U Models.....	13
Figure 2-1. iX2™ Constant-Power: Output Current Versus Voltage,.....	18
Figure 2-2. iX2™ Constant-Power: Output Current Versus Voltage,.....	18
Figure 3-1. Brackets and Handles mounting, 2U Models.....	33
Figure 3-2. Rack mounting Installation.....	35
Figure 3-3. Rear Panel Protective Cover Installation.....	36
Figure 3-4. Installation Drawing, Enhanced 2U Models.....	37
Figure 3-5. Installation Drawing, ATE 2U Models.....	38
Figure 3-6. Rear Panel View, 2U Models, (with GPIB and LKM/LKS options).....	39
Figure 3-7. AC Input Connector and Safety-Ground Stud.....	40
Figure 3-8. AC/DC Output Connector and Functional-Ground.....	42
Figure 3-9. Remote Sense Connector and Functional-Ground.....	43
Figure 3-10. External Input/Output Control Connector.....	47
Figure 3-11. External Interface Signal Connector.....	50
Figure 3-12. External Command Monitor and Trigger Output Connectors.....	51
Figure 3-13. External Clock/Lock Interface Connectors (Option).....	51
Figure 3-14. External Master/Auxiliary System Interface Connectors.....	52
Figure 3-15. RS-232C Interface Connector.....	53
Figure 3-16. USB Interface Connector.....	54
Figure 3-17. LAN Interface 8P8C Modular Connector.....	55
Figure 4-1. Front Panel, Enhanced 2U Models.....	57
Figure 4-2. Front Panel, ATE 2U Models.....	58
Figure 4-3. iX2™ Constant-Power Output Characteristic.....	64
Figure 4-4. HOME Screen.....	65
Figure 4-5. DASHBOARD Screen Menu with Voltage Selection-Field Active.....	65
Figure 4-6. Menu with Only Phase-A Selected.....	65
Figure 4-7. Touch-Screen Numeric Keypad.....	66
Figure 4-8. Rotary Encoder.....	66
Figure 4-9. Output Program Menu Selection-Fields with Phase Number Highlighted.....	67
Figure 4-10. Highlighted Voltage Selection-Field with Value Window.....	67
Figure 4-11. Power-On Screens.....	68
Figure 4-12. HOME Screen.....	69
Figure 4-13. DASHBOARD Screen Top-Level Menu.....	70
Figure 4-14. Real-Time, Immediate Output Parameter Adjustment.....	71
Figure 4-15. Default Screen.....	72
Figure 4-16. OUTPUT PROGRAM Screen Top-Level Menu.....	72
Figure 4-17. MEASUREMENTS Screen Top-Level Menu.....	77
Figure 4-18. HARMONICS Menu.....	80
Figure 4-19. HARMONICS Menu, Table View.....	82
Figure 4-20. HARMONICS Menu, Bar Graph View.....	82
Figure 4-21. TRANSIENTS Screen Top-Level Menu.....	83
Figure 4-22. SETTINGS Menu.....	83
Figure 4-23. SETTINGS Screen, TRIGGER Sub-Menu.....	85
Figure 4-24. VIEW Menu, With Empty Buffer.....	86
Figure 4-25. VIEW Menu, With Transient List Entry.....	86
Figure 4-26. VIEW Menu, ADD Sub-Menu.....	87
Figure 4-27. VIEW Menu, VOLTAGE DROP Sub-Menu.....	90
Figure 4-28. VIEW Menu, VOLTAGE SWEEP/STEP Sub-Menu.....	91
Figure 4-29. VIEW Menu, VOLTAGE SURGE/SAG Sub-Menu.....	92
Figure 4-30. VIEW Menu, FREQUENCY SWEEP/STEP Sub-Menu.....	93
Figure 4-31. VIEW Menu, FREQUENCY SURGE/SAG Sub-Menu.....	94
Figure 4-32. VIEW Menu, VOLT/FREQ SWEEP/STEP Sub-Menu.....	95
Figure 4-33. VIEW Menu, VOLT/FREQ SURGE/SAG Sub-Menu.....	96
Figure 4-34. VIEW Menu, DELAY Sub-Menu.....	97
Figure 4-35. RUN Menu.....	98
Figure 4-36. CONFIGURATION Screen Top-Level Menu.....	99
Figure 4-37. CONFIGURATION Menu, PROFILES Sub-Menu.....	100
Figure 4-38. PROFILES Menu, NAME Sub-Menu.....	100
Figure 4-39. CONFIGURATION Menu, PONS Menu-1/2.....	102
Figure 4-40. CONTROL INTERFACE Screen.....	108

Figure 4-41. CONTROL INTERFACE Menu, ANALOG Sub-Menu	109
Figure 4-42. CONTROL INTERFACE Menu, RS232 Sub-Menu	109
Figure 4-43. CONTROL INTERFACE Menu, GPIB Sub-Menu	110
Figure 4-44. CONTROL INTERFACE, LAN Menu	110
Figure 4-45. CONTROL INTERFACE, LAN CONFIGURE Sub-Menu	111
Figure 4-46. CONTROL INTERFACE REMOTE INHIBIT Menu	113
Figure 4-47. PROTECTION Screen	113
Figure 4-48. APPLICATIONS Screen, Output Impedance Example	114
Figure 4-49. SYSTEM SETTINGS Screen	115
Figure 4-50. SYSTEM SETTINGS Menu, LCD Menu	116
Figure 5-1. HARMONICS Screen, Waveform Information.....	119
Figure 6-1. HARMONICS Menu	123
Figure 6-2. FFT data in Tabular Format	124
Figure 6-3. FFT data in Bar Graph Format.....	125
Figure 6-4. HARMONICS Menu, Triggering	126
Figure 6-5. Post-Trigger (Positive Delay)	127
Figure 6-6. Pre-Trigger (Negative Delay)	128
Figure 7-1. Output Transient Modes.....	131
Figure 7-2. Pulse Transients	132
Figure 7-3. List Transients.....	132
Figure 7-4. Switching Waveforms in a Transient List Transient Execution.....	134
Figure 7-5. RUN Menu: Start and Abort Fields.....	134
Figure 7-6. CONFIGURATION Menu, PROFILES Selection.....	135
Figure 8-1. AUX Generator PWA Potentiometer, R9.....	153

List of Tables

Table 3-1. AC Input Connector Pinout and Safety-Ground.....	41
Table 3-2. AC Input Connector Type	41
Table 3-3. AC/DC Output Connector Pinout and Functional-Ground	42
Table 3-4. AC/DC Output Connector Type and Functional-Ground.....	43
Table 3-5. Remote Sense Connector Pinout	43
Table 3-6. Remote Sense Connector Type	43
Table 3-7. Minimum Wire Size.....	45
Table 3-8. Wire Resistance and Voltage Drop, 20°C.....	46
Table 3-9. External Input/Output Control Connector Type.....	47
Table 3-10. External Input/Output Control Functions.....	48
Table 3-11. External Input/Output Control Connector Pinout	49
Table 3-12. External Interface Signal Connector Type	50
Table 3-13. External Command Monitors and Trigger Output Characteristics	51
Table 3-14. External Clock/Lock Interface Characteristics (Option)	52
Table 3-15. External Master/Auxiliary System Interface Connector Type.....	52
Table 3-16. External Master/Auxiliary System Interface Characteristics	53
Table 3-17. RS-232C Interface Connector Type	53
Table 3-18. RS-232C Interface Connector Pinout	53
Table 3-19. USB Interface Connector Pinout	54
Table 3-20. LAN Interface 8P8C Modular Connector Pinout	55
Table 4-1. Front Panel Controls and Indicators, Enhanced 2U Models	59
Table 4-2. Front Panel Controls and Indicators, ATE 2U Models	60
Table 4-3. HOME Screen Menu Content.....	69
Table 6-1. MEASUREMENTS Screen Parameters	122
Table 6-2. MEASUREMENTS Parameter Value Derivation	123
Table 8-1. Calibration Equipment	136
Table 8-2. Load Values for Output AC Current Alignment.....	146
Table 8-3. Load Values for Output DC Current Alignment.....	146
Table 11-1. Error and Status Messages	160

1. Introduction

This instruction manual contains information on the installation, operation, and calibration of the Asterion Series power source models with 1-phase/3-phase output in 2U chassis. The Asterion Series is the latest generation of switched-mode power sources that provide precise output having high accuracy, low distortion, and fast dynamic response. With extensive programmability and user interface, it offers a rich feature set and functionality: AC and DC output capability, wide output frequency range, arbitrary and harmonic waveform generation, sequencing transient lists, digital power analyzer measurements, real-time waveform display, and the capability to be configured in systems comprised of multi-phase and parallel groups.



Figure 1-1. Asterion Series Front View, 2U Models

1.1 General Description

The Asterion Series power sources are available in 2U chassis at power levels of 1500 VA, 2250 VA, and 3000 VA. Two AC output voltage ranges are provided, 0-200 VAC/0-400 VAC, with a frequency range of 16 Hz-1200 Hz (with up to 5000 Hz as an option), two DC output ranges, 0-250 VDC/0-500 VDC, and a combined AC+DC mode. A wide range of AC and DC loads could be powered, including reactive loads (inductive and capacitive) running at full rated apparent power, and non-linear loads drawing current with high crest factor, up to 7:1.

The output has an $iX2^{\text{TM}}$ constant-power characteristic that provides greater output current at reduced output voltage: up to 2X at 50% of full-scale voltage. Wide-range AC input is accepted, including 100/115/230/240 VAC, 1-phase/3-phase, and 50/60/400 Hz input frequency. Power factor correction of the AC input with low input current harmonics, producing PF of 0.98 in 1-phase input. Up to six 2U units could be connected in parallel or in multi-phase groups, with outputs of up to 18 kVA.

Multiple remote digital communications interfaces are available: standard LAN (Ethernet), USB, and RS-232C, or the optional IEEE-488 (GPIB) interface. The Asterion Virtual Panels program provides a convenient graphical user interface, and the SCPI command set allows access to the full programmability and functionality. Extensive remote analog and discrete digital control interfaces are also provided for specialized control applications. The front panel display has capability for control, programming, and measurements of the power source, and features a menu-based interface with touch-screen data/command entry.

Waveform generation includes standard sine wave and square wave, and extensive programmability to produce complex waveforms based on harmonics or arbitrary parameter value/time relationships. A transient generator could combine sequences of voltage, frequency, and wave shape to simulate real-world AC or DC disturbances and automate a complex profile of power stimulus to the unit under test.

The power analyzer utilizes DSP-based digitization of output parameters to implement measurement functions spanning single parameter values (voltage/current/frequency), power characteristics (true/apparent power, crest factor, power factor), and advanced computation using fast Fourier transform (FFT) derivation of the harmonics and distortion contained in the voltage and current waveforms. Real-time display of output waveforms is possible through the front panel display or the Asterion Virtual Panels.

1.2 Asterion Series Models

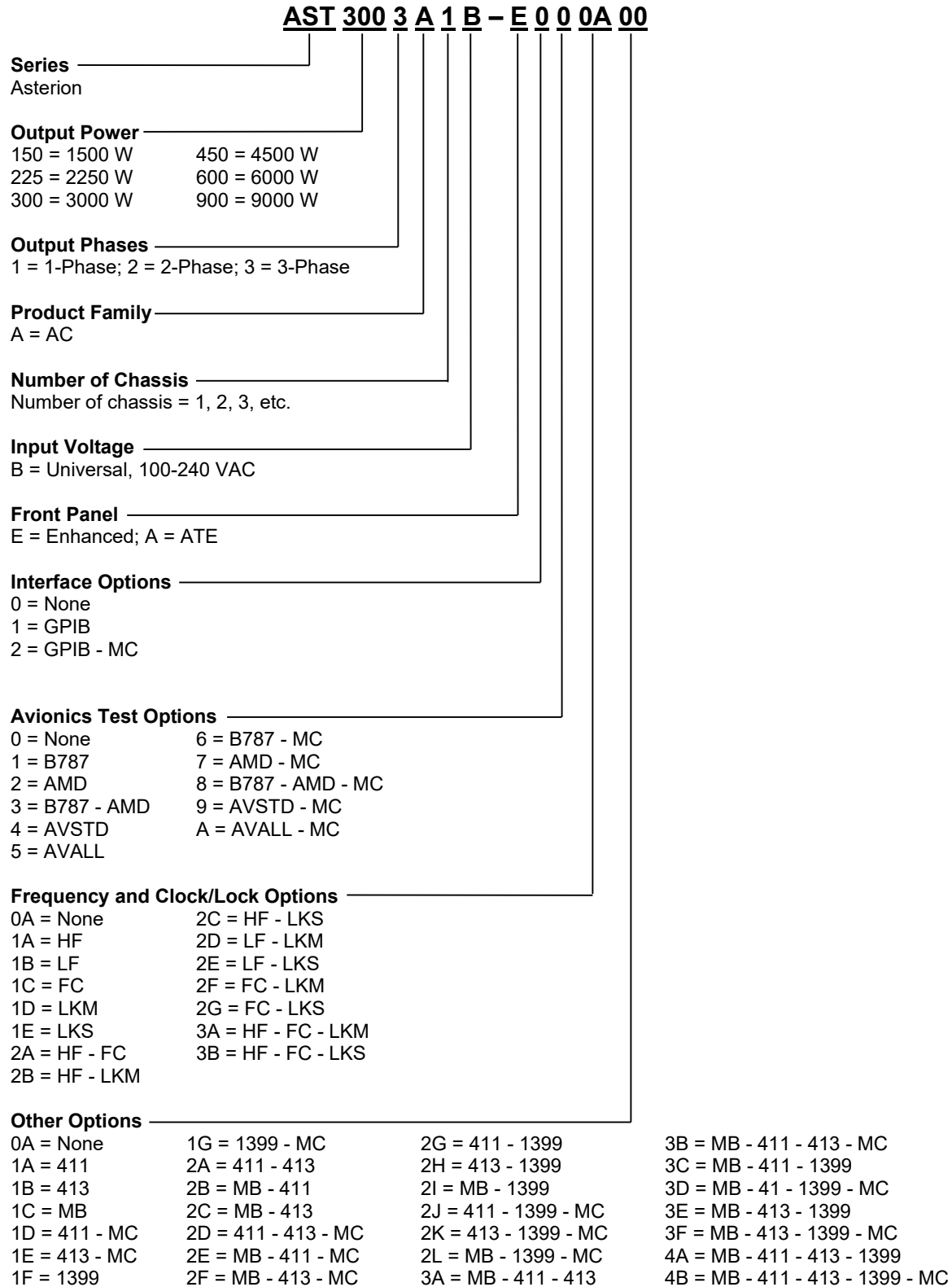

2. Specifications

Unless otherwise noted, the specifications are valid under the following conditions:

1. Ambient temperature of $25 \pm 5^\circ\text{C}$, after a 30-minute warm-up, and at fixed AC input line and load;
2. Individual unit and individual output phase, with sine wave output, and into a resistive load;
3. For system configurations, specifications are for phase output, line-to-neutral; phase angle specifications are valid under balanced resistive load conditions.

2.1 Electrical Characteristics

2.1.1 AC/DC Output Specifications

Model	AST 1503	AST 2253	AST 3001 / AST 3003
Enclosure	2U	2U	2U
Output Phase	1-Phase/3-Phase	1-Phase/3-Phase	AST 3001: 1-Phase; AST 3003: 1-Phase/3-Phase.
Output Power	1,500 VA/1,500 W; 500 W, maximum per phase; derate output power with AC input line-to-line voltage: 1-Phase input, from 1,500 W at 103.5 VAC to 1,300W at 90 VAC.	2,250 VA/2,250 W; 750W, maximum per phase; derate output power with AC input line-to-line voltage: 1-Phase input, from 1,900 W at 132 VAC to 1,300W at 90 VAC; 3-Phase input, from 2,250 W at 132 VAC to 1,500W at 90 VAC.	3,000 VA/ 3,000 W; 1,000 W, maximum per phase; derate output power with AC input line-to-line voltage: 1-Phase input, from 3,000 W at 207 VAC to 2,600 W at 180 VAC, and from 1,900 W at 132 VAC to 1,300W at 90 VAC. 3-Phase input, 2,250 W at 132 VAC to 1,500W at 90 VAC.
AC and AC+DC Output Current, Full-Scale, per phase	Low Range: 2.5 A(RMS) at 200 VAC; iX2™, 5.0 A(RMS) maximum at 100 VAC. High Range: 1.25 A(RMS) at 400 VAC; iX2™, 2.5 A(RMS) maximum at 200 VAC. 1-Phase output mode: rating times 3.	Low Range: 3.75 A(RMS) at 200 VAC; iX2™, 7.5 A(RMS) maximum at 100 VAC. High Range: 1.875 A(RMS) at 400 VAC; iX2™, 3.75 A(RMS) maximum at 200 VAC. 1-Phase output mode: rating times 3.	Low Range: 5 A (RMS) at 200 VAC; iX2™, 10 A(RMS) maximum at 100 VAC. High Range: 2.5A (RMS) at 400 VAC; iX2™, 5.0 A(RMS) maximum at 200 VAC. 1-Phase output mode and model AST 3001: rating times 3.
DC Output Current, Full-Scale, per phase	Low Range: 2.0 ADC at 250 VDC; iX2™, 4.0 ADC maximum at 125 VDC. High Range: 1.0 ADC at 500 VDC; iX2™, 2.0 ADC maximum at 250 VDC. 1-Phase output mode: rating times 3.	Low Range: 3.0 ADC at 250 VDC; iX2™, 6.0 ADC maximum at 125 VDC. High Range: 1.5 ADC at 500 VDC; iX2™, 3.0 ADC maximum at 250 VDC. 1-Phase output mode: rating times 3.	Low Range: 4.0 ADC at 250 VDC; iX2™, 8.0 ADC maximum at 125 VDC. High Range: 2.0 ADC at 500 VDC; iX2™, 4.0 ADC maximum at 250 VDC. 1-Phase output mode and model AST 3001: rating times 3.
Output Current, Maximum RMS	iX2™, 200% of the full-scale RMS current at $\leq 50\%$ of full-scale voltage. Refer to Figure 2-1 and Figure 2-2 for graphs of current rating as a function of output voltage and frequency.		

ix2™ Constant-Power Mode	Constant-Power output capability in each output voltage range with full rated output power from 50% of full-scale output voltage to 100% of full-scale; the output current increases to 200% rated current at 50% full-scale output voltage from 100% rated current at 100% full-scale voltage. Refer to Figure 2-1 and Figure 2-2 for graphs of current rating as a function of output frequency.		
AC and AC+DC Output Voltage, Full-Scale	Low-Range: 0 to 200 V(RMS); High-Range: 0 to 400 V(RMS) HF Option: derate full-scale output voltage from 4 kHz to 5 kHz, as follows, Low Range, $V_{out} \leq 800 \text{ V-kHz} / F_{out} \text{ (kHz)}$; High Range, $V_{out} \leq 1600 \text{ V-kHz} / F_{out} \text{ (kHz)}$.		
Model	AST 1503	AST 2253	AST 3001 / AST 3003
DC Output Voltage, Full-Scale	Low-Range: 0 to 250 VDC; High-Range: 0 to 500 VDC		
DC Offset Voltage, Typical	$\pm 20 \text{ mVDC}$, $\geq 40 \text{ Hz}$		
Output Float Voltage	566 V(PK), maximum from either output terminal to chassis		
Voltage Accuracy	$\pm(0.1\% \text{ of actual} + 0.2\% \text{ of full-scale})$ for DC, and AC 16 Hz to 1.2 kHz; $>1.2 \text{ kHz}$, add $\pm 0.2\% \text{ of full-scale/kHz}$; add $\pm 0.1\% \text{ of full scale}$ for AC+DC mode. Valid from 5% to 100% full-scale; with sense leads connected.		
Voltage Resolution	$\leq 0.02 \text{ V}$, AC, DC, and AC+DC mode		
Voltage Temp. Coefficient, Typical	$\leq 100 \text{ ppm}/^\circ\text{C}$ of full-scale		
Voltage Stability, Typical	$\pm 0.1\% \text{ of full-scale}$ over 8 hours; with constant line, load, and temperature; with sense leads connected		
Voltage Distortion	0.25% maximum, 16 Hz to 100 Hz; 0.5% maximum, $>100\text{Hz}$ to 500 Hz; and 1% maximum, $>500 \text{ Hz}$ to 1.2 kHz, plus 0.5%/kHz to 5 kHz; at full linear load or no load; valid for output voltage $>5\% \text{ of full-scale}$ at full load, and $>15\% \text{ of full-scale}$ at no load.		
Voltage Slew Rate, Typical	$\geq 10 \text{ V}/\mu\text{s}$ with full-scale programmed voltage step		
Current Programming Range	Programmable from zero to 200% of full-scale rating in each output range. Refer to Figure 2-1 and Figure 2-2 for graphs of current rating as a function of output voltage and frequency.		
Current Programming Accuracy	$\pm(0.3\% \text{ of actual} + 0.5\% \text{ of maximum})$ for DC, and AC 16 Hz to 1.2 kHz; add $\pm 0.1\% \text{ of maximum}$ for AC+DC mode. Valid from 5% to 100% of maximum. HF option: for High-Range, add 1.2% of maximum/kHz above 1.2 kHz; for Low-Range, add 0.1% of maximum/kHz above 1.2 kHz. Valid from 20% to 100% of maximum. For multi-chassis configurations, multiply the accuracy by $\sqrt{1.5n}$, where n is number of chassis.		
Line Regulation	$\pm 0.015\% \text{ of full-scale voltage}$, for a $\pm 10\% \text{ input line change}$; DC, or 40 Hz to 5 kHz.		
Load Regulation	$\pm 0.025\% \text{ of full-scale voltage}$, for 100% of rated resistive load change; DC, or 40 Hz to 1.2 kHz, above 1.2 kHz, add $\pm 0.015\% \text{ of full-scale/kHz}$		
V/I Programming Overrange, Typical	1% of full-scale		
Noise Level, Typical	AC output: 450 mV(RMS), low-range; 750 mV(RMS), high-range; at $\geq 40 \text{ Hz}$ output frequency; bandwidth, 20 kHz to 1 MHz; DC output: 400 mV(RMS), low-range; 700 mV(RMS), high-range; bandwidth, 20 Hz to 1 MHz.		
Remote Sense	5 V(RMS), maximum total output lead drop		

Crest Factor	AST 2253, AST 3001: 5:1 of full-scale current per output range (ratio of peak to RMS); AST 1503, AST 3003: 7:1 of full-scale current per output range (ratio of peak to RMS).		
Power Factor	0, lagging to 0, leading		
Frequency Range	Standard models: DC, and 16 Hz to 1.2 kHz; LF option: DC, and 16 Hz to 550 Hz; HF option: DC, and 16 Hz to 5 kHz.		
Model	AST 1503	AST 2253	AST 3001 / AST 3003
Frequency Accuracy	Standard models: $\pm(0.01\%$ of actual + frequency resolution/2) FC option: $\pm 0.25\%$		
Frequency Resolution	0.01 Hz resolution, 16-81.91 Hz; 0.1 Hz resolution, 82-819.1 Hz; 1 Hz resolution, 820-5000 Hz; With LKM/LKS Option: 1 Hz resolution, 16-5000 Hz.		
Frequency Temperature Coefficient, Typical	10 ppm/°C of full-scale in each range		
Phase Programming Range	0.0° to 360.0°, relative to external synchronization signal; in multi-phase group, Auxiliary unit output voltage is relative to the Master unit output voltage, with the Master unit voltage as reference 0°.		
Phase Accuracy	$\pm 1^\circ$, 16 Hz to 100 Hz; $\pm 2^\circ$ >100 Hz to 1.2 kHz, plus $\pm 1^\circ/\text{kHz}$ above 1.2 kHz		
Phase Programming Resolution	$\pm 0.4^\circ$		

2.1.2 iX2™ Constant-Power Mode Output Characteristic

The iX2™ Constant-Power mode has an output characteristic where full rated output power is available from 50% of full-scale output voltage to 100% of full-scale output voltage, as depicted in the graphs of Figure 2-1 and Figure 2-2. The output current versus output voltage follows a constant-power relation where the output current would be 200% of the full-scale value when the output voltage is 50% of full-scale. The current ratings are also a function of output frequency, as shown in Figure 2-1 above 500 Hz for the AST 2253 and AST 3001, and in Figure 2-2 above 1.2 kHz for the AST 1503 and AST 3003.

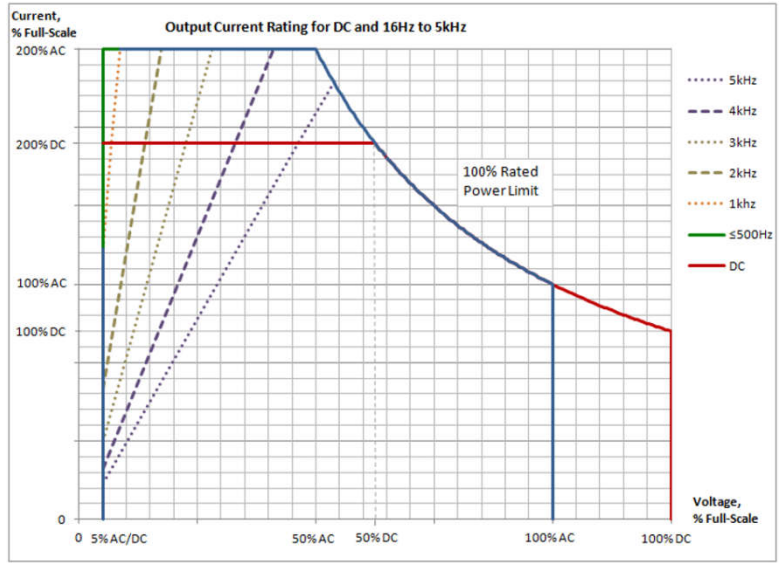

Figure 2-1. iX2™ Constant-Power: Output Current Versus Voltage, AST 2253 / AST 3001

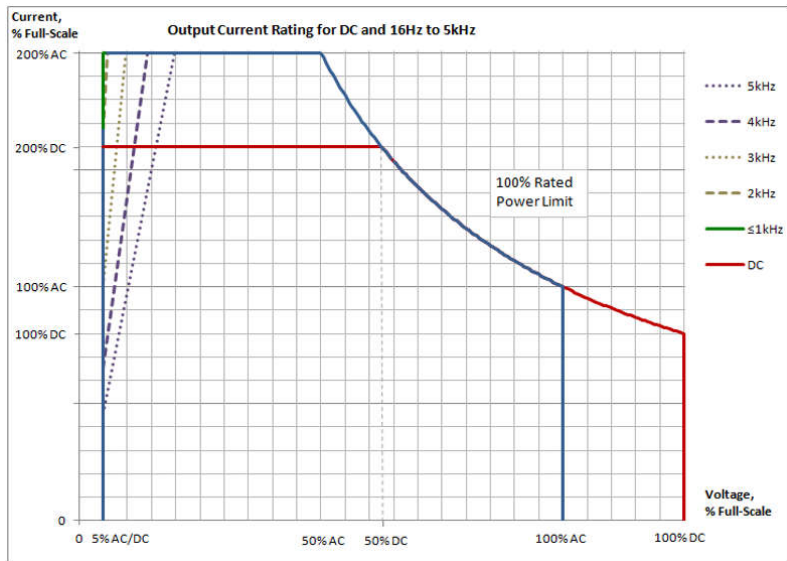

Figure 2-2. iX2™ Constant-Power: Output Current Versus Voltage, AST 1503, AST 3003

2.1.3 AC Input Specifications

Model	AST 1503	AST 2253	AST 3001 / AST 3003
Enclosure	2U	2U	2U
Input Voltage, Nominal Rating	100VAC-120VAC low-input range, and 200-240 VAC high-input range; 1-Phase and 3-Phase, line-neutral or line-line.	100VAC-120VAC low-input range, and 200-240 VAC high-input range; 1-Phase and 3-Phase, line-neutral or line-line.	100VAC-120VAC low-input range, and 200-240 VAC high-input range; 1-Phase and 3-Phase, line-neutral or line-line.
Input Voltage, Operating Range	90-132 VAC low-input range, and 180VAC-264VAC high-input range; refer to output power section for derating as a function of input voltage.	90-132 VAC low-input range, and 180VAC-264VAC high-input range; refer to output power section for derating as a function of input voltage.	90-132 VAC low-input range, and 180VAC-264VAC high-input range; refer to output power section for derating as a function of input voltage.
Input Current, Maximum with 1-Phase Input	20 A(RMS) at 90 VAC to 103.5 VAC; 12 A(RMS) at 180 VAC.	20 A(RMS) at 90 VAC to 132 VAC; 18 A(RMS) at 180 VAC.	20 A(RMS) at 90 VAC to 132 VAC; 20 A(RMS) at 180 VAC to 207 VAC.
Input Current, Maximum with 3-Phase Input	14 A(RMS) at 90 VAC, line-to line; 7 A (RMS) at 180 VAC, line-to line.	14 A(RMS) at 90 VAC, line-to line; 11 A(RMS) at 180 VAC, line-to line.	14 A(RMS) at 90 VAC, line-to line; 14 A(RMS) at 180 VAC, line-to line
Input Frequency, Nominal Rating	50 Hz, 60 Hz, 400 Hz	50 Hz, 60 Hz, 400 Hz	50 Hz, 60 Hz, 400 Hz
Input Frequency Range	47-440 Hz	47-440 Hz	47-440 Hz
Inrush Current, Typical	30 A (PK) at 264 VAC	30 A (PK) at 264 VAC	30 A (PK) at 264 VAC
Efficiency¹, Typical	AST 2253: 75%; AST 3001: 74%; AST 3003: 72%; AST 1503: 69%.	AST 2253: 75%; AST 3001: 74%; AST 3003: 72%; AST 1503: 69%.	AST 2253: 75%; AST 3001: 74%; AST 3003: 72%; AST 1503: 69%.
Power Factor², Typical	0.98; active PFC	0.98; active PFC	0.98; active PFC
Hold-Up Time³, Typical	≥10 ms	≥10 ms	≥10 ms
1-PH Input	2-wire + ground; 264 VAC, maximum		
3-PH Input	3-wire + ground; 264 VAC, maximum line-to-line		
Isolation Voltage	2200 VAC, input to output; 1350 VAC, input to chassis		
¹ At full load and DC or 16 Hz to 1.2 kHz output frequency, with AC input voltage of 115 V(RMS) or 230 V(RMS), and 50/60 Hz input frequency			
² At full load, with 1-phase AC input voltage of 115 V(RMS) or 230 V(RMS), and 50/60 Hz input frequency			
³ At full load and with AC input voltage of 115 V(RMS) or 230 V(RMS)			

2.1.4 AC Output Measurements

Parameter	Specification ¹
Voltage Range, Full-Scale	AC and AC+DC output: 0-500 V(RMS)
Voltage Accuracy	$\pm(0.1\%$ of actual + 0.2% of full-scale) for AC 16 Hz to 1.2 kHz; >1.2 kHz, add $\pm 0.2\%$ of full-scale/kHz; add $\pm 0.1\%$ of full-scale for AC+DC mode. Valid from 5% to 100% full-scale; with sense leads connected.
Voltage Resolution	20 mV
Current Range, Maximum	AST 1503, AST 2253: 7.5 A(RMS) per phase; AST 3003: 15 A(RMS) per phase; AST 3001: 30 A(RMS), 1-phase output model; 1-Phase output mode in 3-Phase models: rating times 3.
Current Accuracy	$\pm(0.3\%$ of actual + 0.5% of maximum) for AC 16 Hz to 1.2 kHz; add $\pm 0.1\%$ of maximum for AC+DC mode. Valid from 5% to 100% of maximum. HF Option: for High-Range, add 1.2% of maximum/kHz; for Low-Range, add 0.1% of maximum/kHz. Valid from 20% to 100% of maximum.
Current Resolution	2 mA; 1-Phase output mode in 3-Phase models and model AST 3001: 6 mA.
Peak Current Range, Maximum	AST 1503, AST 2253: $\pm 0-18.75$ A(PK) per phase; AST 3003: $\pm 0-37.5$ A(PK) per phase; AST 3001: $\pm 0-75$ A(PK), 1-phase output model; 1-Phase output mode in 3-Phase models: rating times 3.
Peak Current Accuracy	$\pm(0.5\%$ of actual + 0.7% of maximum) for AC 16 Hz to 1.2 kHz; add $\pm 0.1\%$ of maximum for AC+DC mode. Valid from 5% to 100% of maximum. HF Option: for High-Range, add 1.2% of maximum/kHz; for Low-Range, add 0.1% of maximum/kHz. Valid from 20% of full-scale to 200% of full-scale.
Peak Current Resolution	5 mA; 1-Phase output mode in 3-Phase models and model AST 3001: 15 mA.
Frequency Range	16 Hz to 5.0 kHz
Frequency Accuracy	$\pm(0.01\%$ of actual + frequency resolution/2)
Frequency Resolution	0.01 Hz: 16-81.91 Hz; 0.1 Hz: 82.0-819.1 Hz; 1 Hz: 820-5.0 kHz
Phase Range	0-360°
Phase Accuracy	$\pm 1^\circ$, 16 Hz to 100 Hz; $\pm 2^\circ$, >100 Hz to 1.2 kHz; $\pm 5^\circ$, >1.2 kHz
Phase Resolution	0.1° , 16-100 Hz; 1° , >100 Hz to 5 kHz
Real Power Range, Full-Scale	Output power rating of model.
Real Power Accuracy	$\pm(0.4\%$ of actual + 0.7% of full-scale) for AC 16 Hz to 1.2 kHz; >1.2 kHz, add $\pm 0.4\%$ of full-scale/kHz; add $\pm 0.2\%$ of full-scale for AC+DC mode.
Real Power Resolution	1 W
Apparent Power	Output power rating of model.
Apparent Power Accuracy	$\pm(0.4\%$ of actual + 0.7% of full-scale) for AC 16 Hz to 1.2 kHz; >1.2 kHz, add $\pm 0.4\%$ of full-scale/kHz; add $\pm 0.2\%$ of full-scale for AC+DC mode.
Apparent Power Resolution	1 VA
Power Factor Range	0-1

Parameter	Specification ¹
Power Factor Accuracy	±2% of full-scale
Power Factor Resolution	0.01
¹ Accuracy specifications apply above 100 counts of resolution; for multi-chassis configurations, multiply the output current and power by the number of chassis, and their accuracy specifications by $\sqrt{1.5n}$, where n is number of chassis; power factor accuracy applies for PF > 0.5 and output apparent power > 50% of maximum rating; frequency measurement specifications valid for output voltage >5% of full-scale.	

2.1.5 DC Output Measurements

Parameter	Specification ¹
Voltage Range, Full-Scale	±500 VDC
Voltage Accuracy	±(0.1% of actual + 0.2% of full-scale); valid from 5% to 100% of full-scale; with sense leads connected.
Voltage Resolution	25 mV
Current Range, Maximum	AST 1503, AST 2253: 6 ADC per phase; AST 3003: 12 ADC per phase; AST 3001: 24 ADC, 1-phase output mode;. 1-Phase output mode in 3-Phase models: rating times 3.
Current Accuracy	±(0.5% of actual + 0.7% of maximum); valid from 5% to 100% of maximum.
Current Resolution	2 mA; 1-Phase output mode in 3-Phase models and model AST 3001: 6 mA.
Peak Current Range, maximum	AST 1503, AST 2253: ± 0-18.75 A(PK) per phase; AST 3003: ± 0-37.5 A(PK) per phase; AST 3001: ± 0-75 A(PK), 1-phase output model; 1-Phase output mode in 3-Phase models: rating times 3.
Peak Current Accuracy	±(0.5% of actual + 0.7% of maximum); valid from 5% to 100% of maximum.
Peak Current Resolution	5 mA; 1-Phase output mode in 3-Phase models and model AST 3001: 15 mA.
Power Range, Full-Scale	Output power rating of model.
Power Accuracy	±(0.4% of actual + 0.7% of full-scale)
Power Resolution	1 W
¹ Accuracy specifications apply 100 counts of resolution; for multi-chassis configurations, multiply the output current and power by the number of chassis, and their accuracy specifications by $\sqrt{1.5n}$, where n is number of chassis.	

2.1.6 Harmonics Measurements

Parameter	Specification ¹
Frequency, Fundamental	16-81.91 Hz, 82.0-819.1 Hz, 820-960 Hz
Fundamental Frequency Resolution	0.01 Hz: 16-81.91 Hz; 0.1 Hz: 82.0-819.1 Hz; 1 Hz: 820-960 Hz
Harmonic Frequency	32 Hz to 48 kHz; 2nd to 50th harmonic
Fundamental Voltage Accuracy	±(0.2% of actual + 0.3% of full-scale) for 16 Hz to 960 Hz.
Fundamental Voltage Resolution	20 mV
Harmonic Voltage Accuracy	±(0.2% of actual + 0.3% of full-scale + 0.3% of full-scale/kHz).
Harmonic Voltage Resolution	20 mV
Fundamental Current Accuracy	±(0.4% of actual + 0.6% of maximum) for 16 Hz to 960 Hz.
Fundamental Current Resolution	2 mA; 1-Phase output mode in 3-Phase models: 6 mA.
Harmonic Current Accuracy	±(0.4% of actual + 0.6% of maximum + 0.4% of maximum/kHz).
Harmonic Current Resolution	2 mA; 1-Phase output mode in 3-Phase models: 6 mA.
¹ Accuracy specifications apply above 100 counts of resolution; for multi-chassis configurations, multiply the current accuracy by $\sqrt{1.5n}$, where n is number of chassis. Voltage and current measurements are valid from 5% to 100% maximum in each range.	

2.1.7 Protection Function Characteristics

Function	Characteristic
Output Overvoltage Protection (OVP)	Programmable to 115% of full-scale output voltage; exceeding OVP threshold results in shutdown of output.
Output Current Limit Protection	User-selectable constant-current mode or current-limit mode, with programmable current setpoint; in constant-current mode, output current is regulated to setpoint; in current-limit mode, exceeding current-limit setpoint results in shutdown of output; current limit delay: programmable from 100 ms to 10s.
Output Short-Circuit Protection	Instantaneous and RMS current-limit
AC Input Overcurrent Protection	Internal fuses in each phase for fault isolation; not user replaceable
AC Input Undervoltage Protection	Automatic shutdown for insufficient AC input voltage
AC Input Transient Protection	Protection to withstand EN61326-1, Class-A surge levels
Overtemperature Protection (OTP)	Internal temperature monitors cause shutdown of output if temperature thresholds are exceeded

2.2 Regulatory Agency Compliance

Parameter	Specification
EMC	CE marked for EMC Directive 2014/30/EU per EN 61326-1:2013 Class A for Emissions and Industrial Immunity levels as required.
Safety	NRTL certified for US and Canada to CAN/CSA-C22.2 No. 61010-1-12, UL 61010-1 Third Edition. CE marked for LVD Directive 2014/35/EU to EN 61010-1 Third Edition as required.
CE Mark LVD Categories	Installation Overvoltage Category II, Pollution Degree 2, Indoor Use Only.
RoHS	CE marked for RoHS Directive 2011/65/EU per EN IEC 63000:2018 as required.

2.3 Environmental Specifications

Parameter	Specification
Operating Temperature	0°C to 40°C (32° F to 104° F)
Storage Temperature	-40°C to 85°C (-40°F to 185° F)
Altitude	2000 m (6,562 ft)
Relative Humidity	5-95 %, non-condensing
Vibration	MIL-PRF-28800F, Class 3; 5-500 Hz per Paragraph 4.5.5.3.1.
Shock	MIL-PRF-28800F, Class 3; 30G half-sine with 11ms duration per Paragraph 4.5.5.4.1.
Transportation Integrity	ISTA Test Procedure 1A

2.4 Mechanical Specifications

Parameter	Specification
Dimensions	H, 3.47" (88.1 mm); W (front panel), 18.9" (480 mm); D, 23.0" (584 mm); H, 3.47" (88.1 mm); W (chassis), 16.9" (429 mm); D, 23.0" (584 mm).
Unit Weight	AST 1503/2253: 39 lb. / 17.7 kg; AST 3001: 42 lb. / 19.1 kg; AST 3003: 48 lb. / 21.8 kg.
Shipping Weight	AST 1503/2253: 45 lb. / 20.4 kg; AST 3001: 48 lb. / 21.8 kg; AST 3003: 54 lb. / 24.5 kg.
Chassis Material	Steel with plastic front panel
Chassis Finish	Galvanized Zinc, G90
Installation	Protective covers are provided for AC input and AC/DC output; bench-top: removable feet for the chassis; rack-mount: per ANSI-EIA-310-D, with front panel mounting flanges and chassis provisions for mounting rack slides; slides option available.
Cooling	Force-air cooling; linear, variable fan speed control; air intake at front/sides and exhaust at rear.
Acoustic Noise	59 dBA, maximum; measured at 1 m with A-weighting.

2.5 Remote Control Digital Interface Characteristics

Interface	Characteristic
LAN	Ethernet 10BASE-T and 100BASE-T over twisted-pair cables compliant with IEEE 802.3; Connector: 8P8C modular jack.
USB	Serial interface compliant to USB 2.0; Connector: Type-B receptacle.
RS-232C	Serial interface compliant to RS-232C; Protocol: data bits, 7 with parity and 8 without parity; stop bits, 2; baud rate, 9600 to 115200; handshake, CTS and RTS; Connector: Subminiature-D, 9-contact receptacle.
IEEE-488 (Option)	Parallel interface complies with IEEE-488.1, IEEE-488.2, and the SCPI command specification; command execution response time, 10 ms, typical; connector: IEEE-488.1 compliant.
Firmware Upgrade	Firmware could be upgraded through the LAN (units built starting September 2018), USB, or RS-232 interfaces. Upgrade through IEEE-488 is not supported.

2.6 Remote Control Analog/Digital Signal Characteristics

Function	Characteristics
External Analog Programming of Output Voltage Waveform	Signal input for output voltage waveform programming by external analog reference; AC or DC input signal: 0V to user-selectable maximum range value within ± 2.5 V(PK) to ± 10 V(PK), corresponding to maximum range of 1.77 V(RMS) to 7.07 V(RMS), for zero to full-scale RMS output voltage; with AC waveform, from 16 Hz to 5 kHz (option dependent); programming accuracy, $\pm 2\%$ of full-scale output; input impedance, 40 k Ω , typical.
External Analog Programming of Output Voltage Amplitude	Signal input for output voltage amplitude programming; waveform is set by internal controller reference; DC input signal: 0V to user-selectable maximum range value within 2.5 VDC to 10 VDC, for zero to full-scale RMS of internally programmed output voltage waveform; programming accuracy, $\pm 2\%$ of full-scale output; input impedance, 40 k Ω , typical.
External Analog Modulation of Output Voltage	Signal input for output voltage modulation; waveform is set by internal controller reference; AC or DC signal with 0V to ± 7.07 V(PK), 0-5 V(RMS) for 0-20% of full-scale output voltage amplitude modulation; programming accuracy, $\pm 2\%$ of full-scale output; input impedance, 40 k Ω , typical.
Trigger Output	Signal output with dual function: user selectable as either function trigger or list trigger; function trigger provides a pulse for any programmable change in output voltage or frequency; list trigger provides a pulse if programmed as part of list transients; logic level, active-low pulse with duration of 550 μ s, typical.
Output Voltage Monitor Outputs	Signal outputs for each output phase for monitoring the waveforms of the command signals of the output amplifiers; 0-5 V(RMS), typical, signal range for zero to full-scale output voltage.
Trigger Input	Signal input for external trigger for execution of programmed values or transient lists; logic level, TTL-compatible.
Synchronization Signal (SYNC) Input	Signal input for external square wave to control the output frequency and phase, with waveform generated by the internal reference; logic level, TTL-compatible.
Remote Inhibit Input	Signal input to turn the output off/on; logic level, TTL-compatible; user-selectable as active-high or active-low.
Summary Fault Switch Output	Switch output indicating that a Summary Fault (DFI) condition is present; normally closed, bidirectional AC/DC solid-state switch; closed-circuit for fault or when unit is turned off (open circuit for no fault present); switch ratings: ± 12 V, maximum peak voltage; 0.1A, maximum current; 2.5 Ω , maximum closed resistance; 6A, maximum open-circuit leakage current at 12V.
LKM (Option)	Signal outputs for Master Clock and Lock signals used in synchronizing two or more power sources; logic level, TTL-compatible.
LKS (Option)	Signal inputs for Auxiliary Clock and Lock signals used in synchronizing two or more power sources; logic level, TTL-compatible.

2.7 Operational Characteristics

Parameter	Characteristic
Parallel Operation	Multi-chassis configurations could be formed with up to six units paralleled in 1-phase or multi-phase groups, using one master unit and up to five units operating as auxiliary units. Setup of the multi-chassis configuration is automatically accomplished when the chassis is interconnected with the interface cables, and require no user setup, except to wire the outputs.
Output Relays	Isolation and range relays are provided internally to automatically configure the outputs, turn the output on/off, and disconnect the load from the output amplifier when in the off state.
Non-Volatile Memory	16 complete instrument setups and transient lists, 100 events per list.
Transient Generator	Output could be controlled to produce transient events with 500 μ s programming resolution: Voltage: drop, step, sag, surge, sweep; Frequency: step, sag, surge, sweep; Voltage and Frequency: step, sweep.
Reliability	MTBF: > 80,000 hr.; calculation method: Telcordia SR-332, Issue 3; method: Method I (Parts Count), Case 2 (Temp 40°C, Stress 50%, Burn-in 4 hr.); ambient temperature: 40°C; temperature variation: 10°C; environment: Ground, Fixed, Controlled; duty cycle: 100%; stress factor: 50%; quality level: 1; upper confidence level: 90%
Calibration	Calibration interval is 1 year; calibration is firmware-based through the digital interface or Virtual Panels.
Fault Identification	On-board diagnostics identify when an assembly has experienced a fault.
XLOAD Output Characteristic	User-selectable XLOAD mode provides revised regulation characteristics for additional stability margins when driving large capacitive loads.
Automatic Level Control (ALC)	User-selectable ALC operation enables a digitally implemented feedback control loop to provide precise regulation of the RMS value of the output voltage.
LF, option	Low frequency option: output frequency range of 16 Hz to 550 Hz.
HF, option	High frequency option: output frequency range of 16 Hz to 5 kHz.
FC, option	Reduced frequency control option: $\pm 0.25\%$ accuracy of output frequency; deletes external waveform programming signal.
LKM, option	Clock and Lock interface option, Master unit.
LKS, option	Clock and Lock interface option, Auxiliary unit.
MB, option	Upgrades all chassis to Enhanced models in a multi-chassis configuration.

2.8 Front Panel Controls/Indicators

Model Type	Controls/Indicators
Enhanced	<p>Touch-Panel, TFT color LCD display with menu-based control; rotary encoder for menu navigation and parameter adjustment and entry, with integrated selection switch.</p> <p>POWER switch: turns unit on/off.</p> <p>OUTPUT switch turns output of the unit on/off.</p> <p>OUTPUT LED: integrated into the OUTPUT switch; indicates that the output of the unit has been turned on.</p> <p>CC LED: indicates that the unit is in constant-current mode and the output current is being regulated.</p> <p>CV LED; indicates that the unit is in constant-voltage mode and the output voltage is being regulated.</p> <p>HI RNG LED: indicates that the high-voltage output range has been selected;</p> <p>FAULT LED: indicates that an internal fault has been detected and the output has been shut down.</p> <p>REM LED: indicates that the unit is under control of the remote digital interface.</p> <p>LXI LED: LXI status annunciation.</p>
ATE	<p>No front-panel display; only status indicators.</p> <p>POWER switch: turns unit on/off.</p> <p>UPDATE switch enables bootloader for firmware upgrade.</p> <p>POWER LED: indicates that the POWER switch has turned the unit on.</p> <p>OUTPUT LED: indicates that the output of the unit has been turned on.</p> <p>CC LED: indicates that the unit is in constant-current mode and the output current is being regulated.</p> <p>CV LED; indicates that the unit is in constant-voltage mode and the output voltage is being regulated.</p> <p>HI RNG LED: indicates that the high-voltage output range has been selected.</p> <p>FAULT LED: indicates that an internal fault has been detected and the output has been shut down.</p> <p>REM/LAN LED: indicates that the unit is under control of the remote digital interface, and LXI status annunciation.</p>

2.9 Rear Panel Connectors

Connector	Description
AC Input	1-Phase AC input: L1 and L2, or L2 and L3; 3-Phase AC input: L1, L2, and L3; connector: compression terminals, Phoenix P/N 1703050.
Safety-Ground	M4-0.7 chassis stud
AC/DC Output	Phase-A/B/C Line and Return (RTN) connections; connector: X4 compression terminals, Phoenix P/N 1720819.
AC/DC Output Remote Sense	Phase-A/B/C Line and Return (RTN) connections; part of AC/DC output connector, X4 compression terminals, Phoenix P/N 1703034.
Functional-Ground	M4-0.7 chassis stud
External Interface	Control signal interface to external chassis; connector: high-density, 15-contact, female Subminiature-D.
External Input/Output Control	Control analog/digital signal interface for user remote control; safety isolation SELV-rated; connector: high-density, 15-contact, female Subminiature-D.
Auxiliary Interface	Control signal interface on Auxiliary unit coming from Master unit (or previous Auxiliary unit) for multi-chassis operation; connector, high-density, 26-contact, female Subminiature-D.
Master Interface	Control signal interface on Master unit (or previous Auxiliary unit) going to Auxiliary unit for multi-chassis operation; connector: high-density, 26-contact, female Subminiature-D.
Clock and lock (LKM and LKS options)	Signal control interfaces for synchronization of multiple units; signal outputs on Master unit, and signal inputs on Auxiliary units; safety isolation SELV-rated; connectors: individual BNC.
Command Monitor Outputs	Signal outputs of each output phase for monitoring waveforms of command signals to internal output amplifiers; safety isolation SELV-rated; connector: individual BNC.
Trigger Output	Signal output with dual function, either function trigger or list trigger; safety isolation SELV-rated; connector: BNC.
LAN Interface	Ethernet 10BASE-T and 100BASE-T; safety isolation SELV-rated, referenced to chassis; connector: 8P8C modular jack.
RS-232C Interface	Serial interface to RS-232C; safety isolation SELV-rated, referenced to chassis; connector: Subminiature-D, 9-contact receptacle.
USB Interface	Serial interface to USB 2.0; safety isolation SELV-rated, referenced to chassis; connector: Type-B.
IEEE-488 Interface (Option)	Parallel interface to IEEE-488.1, IEEE-488.2; safety isolation SELV-rated, referenced to chassis; connector: IEEE-488.1 compliant.

2.10 Firmware/Software Options

Option ¹	Description
B787, (MC)	Avionics Electrical Power Quality Test Software; Boeing 787B3-0147 A/B/C (B787).
AMD, (MC)	Avionics Electrical Power Quality Test Software; Airbus AMD24 C (A400M).
B787 & AMD, (MC)	Includes both B787 and AMD options.
AVSTD, (MC)	Avionics Electrical Power Quality Test Software Package; includes 160 (RTCA/DO160 E/F/G), 704 (MIL-STD 704 A/B/C/D/E/F), ABD (Airbus ADB100.1.8 D/E), A350 (Airbus ADB100.1.8.1 B/C).
AVALL, (MC)	Avionics Electrical Power Quality Test Software Package; includes AVSTD, B787, AMD.
1399, (MC)	MIL-STD-1399-300B shipboard power test software
411, (MC)	IEC 61000-4-11 voltage dips and interrupts EMC test software.
413, (MC)	IEC 61000-4-13 harmonics and Inter-harmonics EMC test hardware and software.
411 & 413, (MC)	Includes both 411 and 413 options.
MC	Options are installed in all chassis of a multi-chassis (MC) configuration.
¹ For Avionics options, reference the Avionics Software Manual (P/N 4994-971) for test details. All options require the use of the Asterion Virtual Panels graphical user interface Windows application software (reference CD ROM CIC496). Refer to the AMETEK Programmable Power website, www.programmablepower.com , to download latest version.	

3. Installation

3.1 Unpacking

Inspect the shipping carton for possible damage before unpacking the unit. Carefully unpack the equipment. Save all packing materials until inspection is complete. Verify that all items listed on the packing lists have been received. Visually inspect all exterior surfaces for dented or damaged exterior surfaces, and broken connectors, display, or controls. External damage might be an indication of internal damage.

If any damage is evident, immediately contact the carrier that delivered the unit and submit a damage report. Failure to do so could invalidate future claims. Direct repair issues to AMETEK Customer Service Department at 858-458-0223 (local) or 1-800-733-5427 (toll free in North America).

3.1.1 Contents of Shipment

Depending on the model, configuration, and options selected for your Asterion Series power source, the ship kit may include additional parts and accessories.

Minimum items included in the ship kit (P/N 5330307-01R):

1. Certificate of Conformance (P/N 0152546);
2. Output mating connector (P/N, 893-177-78);
3. Protective cover for AC input, with fastening nuts (cover P/N 9330182-01; M4 nuts P/N MN-M04K-07, quantity three);
4. Strain relief for AC input cable, with mounting nut (strain relief P/N 109-346-00; nut P/N MN-12PT-NNY);
5. Protective cover for AC/DC output, with fastening nuts (cover P/N 9330207-01; M4 nuts P/N MN-M04K-07, quantity two);
6. Bench-top chassis feet (quantity, four), with fastening screws/washers (bumper P/N 109-075-37; M3 screw P/N 075072, quantity four; washer P/N 075075, quantity four);
7. Rackmount flange bracket kit (P/N 5330308-01R, quantity two; includes four M4 mounting screws P/N FM1001);
8. Brackets and handles kit P/N 5330308-01R (includes brackets P/N 9330403-01R, quantity two; handles P/N 863-812-41, quantity two; 8-32 screw P/N 110EF04-06, quantity four; M4 screw P/N FM1001, quantity four).

Note: If any of these parts are missing, contact AMETEK Customer Service Department at 858-458-0223 (local) or 1-800-733-5427 (toll free).

Optional accessories:

- 890-010-01: Auxiliary cable, 12" long; one cable is required per unit that is placed in parallel; up to five additional units could be paralleled;
- 890-010-26: Auxiliary cable, 60" long; one cable is required per unit that is placed in parallel; up to five additional units could be paralleled;
- 250562: LKM/LKS options (Clock/Lock) interface cables, 36" long; two cables are required for every pair of units in a multi-phase group;
- 250561: LKM/LKS options (Clock/Lock) interface BNC T-adapters; two adapters are required for every pair of units in a multi-phase group;

5330201-01R: Rackmount slide kit; includes two slides with rack adapter brackets and mounting hardware.

3.2 Mechanical Installation

The Asterion Series power source is designed for rackmount and bench-top applications. It could be used free standing on a bench top or rack mounted using optional mounting hardware. For bench-top use, the ship kit contains the four bumper feet for installing to the bottom of the chassis using 8 mm long M3-0.5 Philips pan-head screws and 3 mm washers. Rack mounting requires installing the flange brackets with handles to the side of the chassis: using 6 mm long M4-0.7 Philips flat-head screws to mount the brackets to the chassis, and # 8-32 Philips flat-head screws to mount the handles to the brackets.

The unit is forced air cooled with internal fans drawing air in from the front and sides and exhausting at the rear. The front and rear of the unit must be kept clear of obstruction and clearance must be maintained to allow unimpeded airflow. The same consideration given to the side grilles will minimize internal temperature rise. Special consideration must be made to overall air flow characteristics, and the resultant internal heat rise, when a source is installed inside enclosed cabinets to avoid excessive heating and over-temperature problems. The temperature of the ambient air at the air intake should not exceed 40°C.

**WARNING!**

This unit is intended for installation in a protected environment. Exposure to conductive contaminants or corrosive compounds/gases that could be ingested into the chassis could result in internal damage. Install the power source in a temperature and humidity controlled indoor area.

**CAUTION!**

The power source should be provided with proper ventilation. The front and rear of the unit must be free of obstructions. To ensure proper airflow, a minimum 2" clearance from the rear air outlet is required.

**CAUTION!**

No serviceable user parts are inside; service is only to be performed by qualified personnel.

3.2.1 Brackets and Handles

The bracket and handles kit consist of the following items:

5330308-01R 2U				
Part Number	Description	MFG	Item #	Qty
9330403-01R	BRACKET,2U, CHAS EAR MTG -DYN	CD ALEXANDER	1	2
863-812-41	HANDLE,1/4RND,1-1/2HX2-1/2L,AL	HANDLES UNLIMITED	2	2
110EF04-06	SCREW,8-32 X .375,PFH,82D,CS	ANY	3	4
FM1001	SCREW,M4,18-8,FLAT HD,SS,.7X6	ANY	4	4

Recommended kit installation instructions are as follows:

1. Install the brackets, item **#1**, to the front side panels with M4 screws, item **#4**, (two on each side).
2. Tightening torque is 11 in-lb.
3. Install the handles, item **#2**, to the brackets, item **#1**, with 8-32 screws, item **#3** (two one each side).
4. Tightening torque is 11 in-lb.

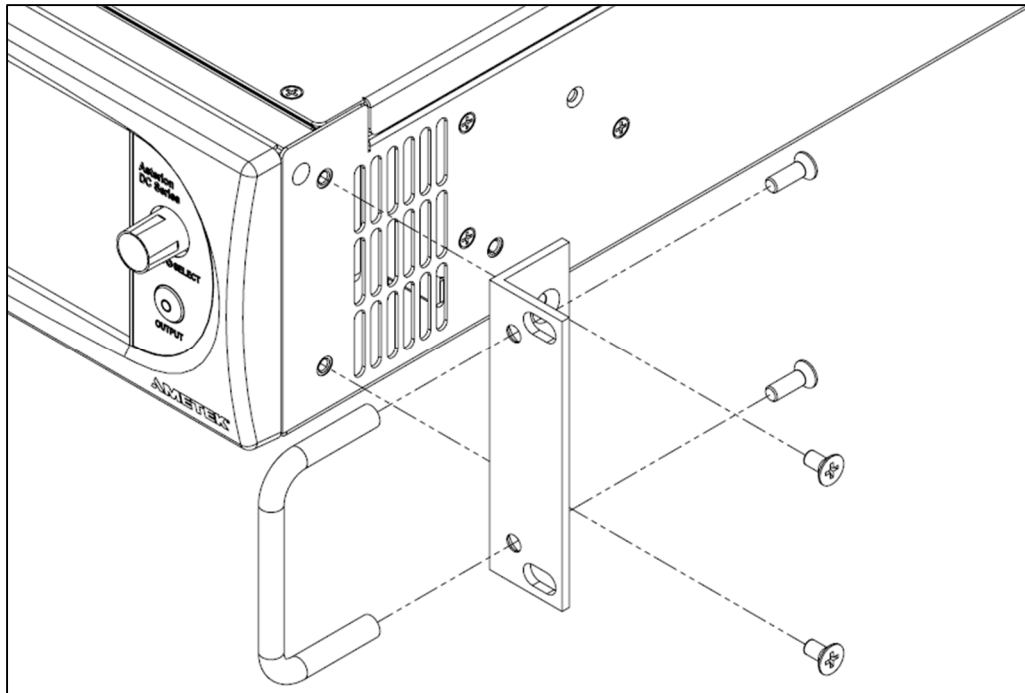

Figure 3-1. Brackets and Handles mounting, 2U Models.

3.2.2 Rack mounting

The Asterion Series power source is designed for mounting in a standard 19-inch equipment rack that is compliant to ANSI/EIA-310-D. If other instrumentation is mounted in the rack adjacent to the unit, there is no need for additional clearance above or below the source. It should be supported in the rack using appropriate L-brackets or rackmount slides. Refer Figure 3-2 to for typical rackmount installation.

Recommended rackmount kits are as follows:

Rackmount Slide Kit (Option): AMETEK part number 5330201-01R

Rackmount Flange Bracket Kit (Option): AMETEK part number 5330241-01R

Install the rackmount kit as follows:

1. Install the slide sections, (1), on both sides of the power supply chassis with screws, (6), (three on each side).
2. Install the brackets, (4), to the stationary slide sections, (3), with screws, (6), and nuts, (5), (four on each side).
3. Adjust the location of the mounting brackets as required for the particular type of rack cabinet vertical rails utilized.
4. Mount the stationary slide sections, (3), (with brackets already installed) into the cabinet using appropriate hardware (e.g. the screws and nuts supplied, (8) and (7), or user-supplied bar-nuts, cage-nuts, clip-nuts), while ensuring that they are level, front to back and left to right, on the cabinet rails.
5. Insert adjustable side sections, (2) stationary slide sections, (3). Insert power supply chassis with installed slide sections, (1), into the adjustable slide sections, (2).

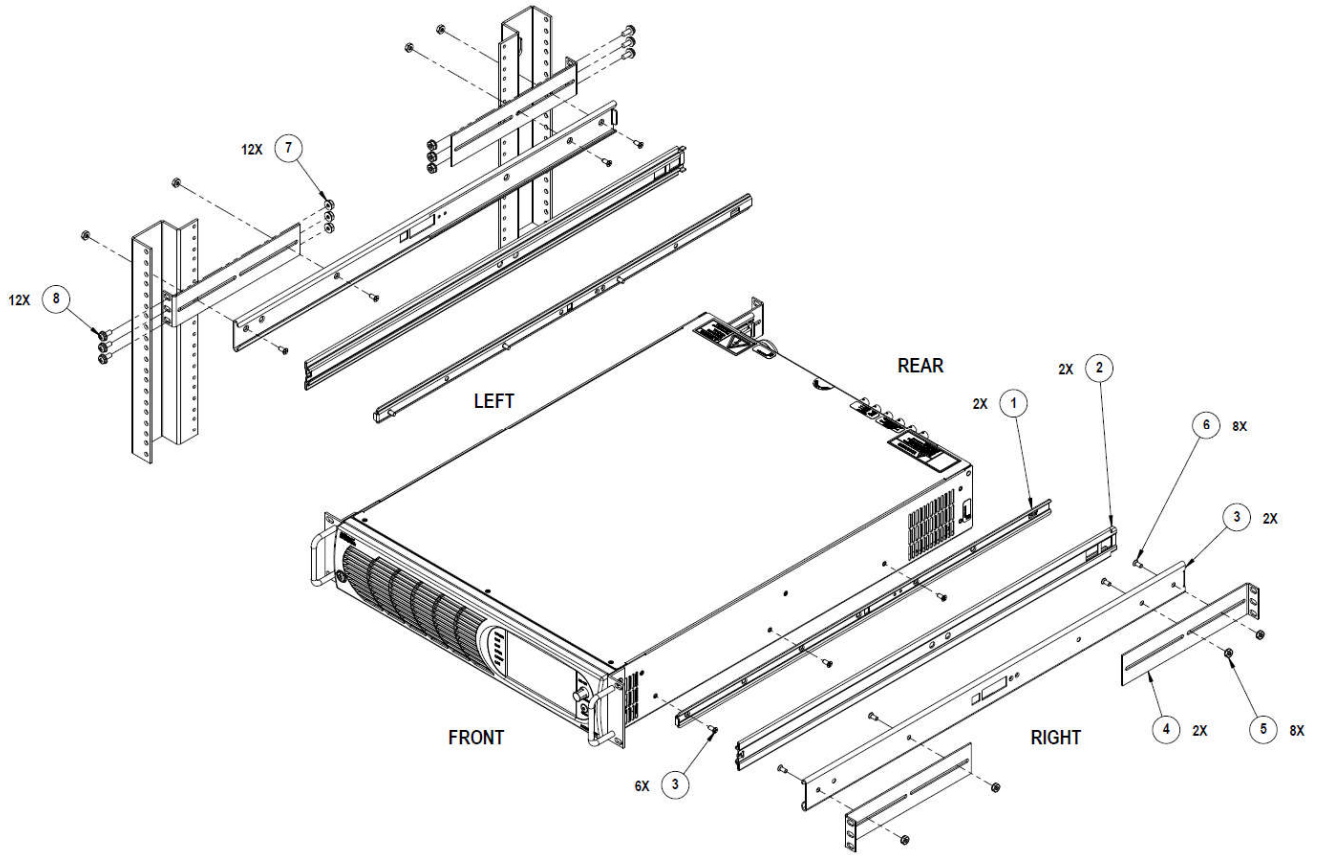

Figure 3-2. Rack mounting Installation

3.3 Outline Drawings

Figure 3-3 and Figure 3-4 show the outlines and overall dimensions for installation of the 2U models, Enhanced and ATE, of the Asterion Series power source. Figure 3-2 shows the protective covers for the AC input and AC/DC output. Figure 3-5 shows locations of rear panel connectors.

3.4 Rear Panel Protective Covers

Protective covers are provided for the rear panel AC input connector and AC/DC output connector. They are installed to studs on the rear panel, as shown in Figure 3-3, using M4-0.7 KEPS-nuts with a maximum tightening torque of 1.1 Nm (10 lb.-in). The components comprising the covers are supplied in the ship kit.

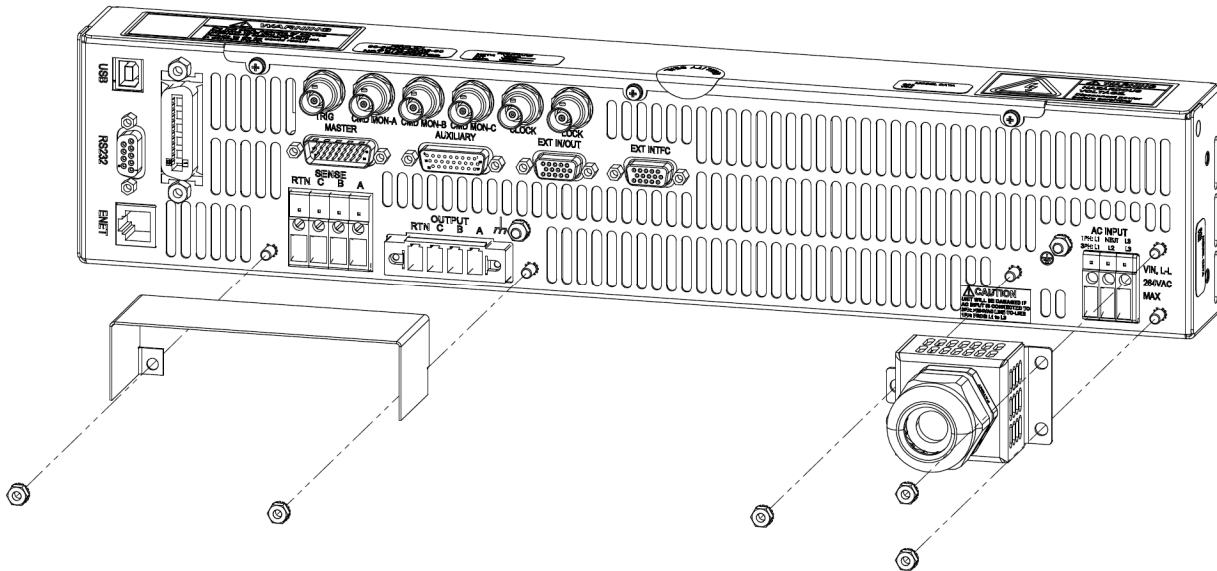

Figure 3-3. Rear Panel Protective Cover Installation

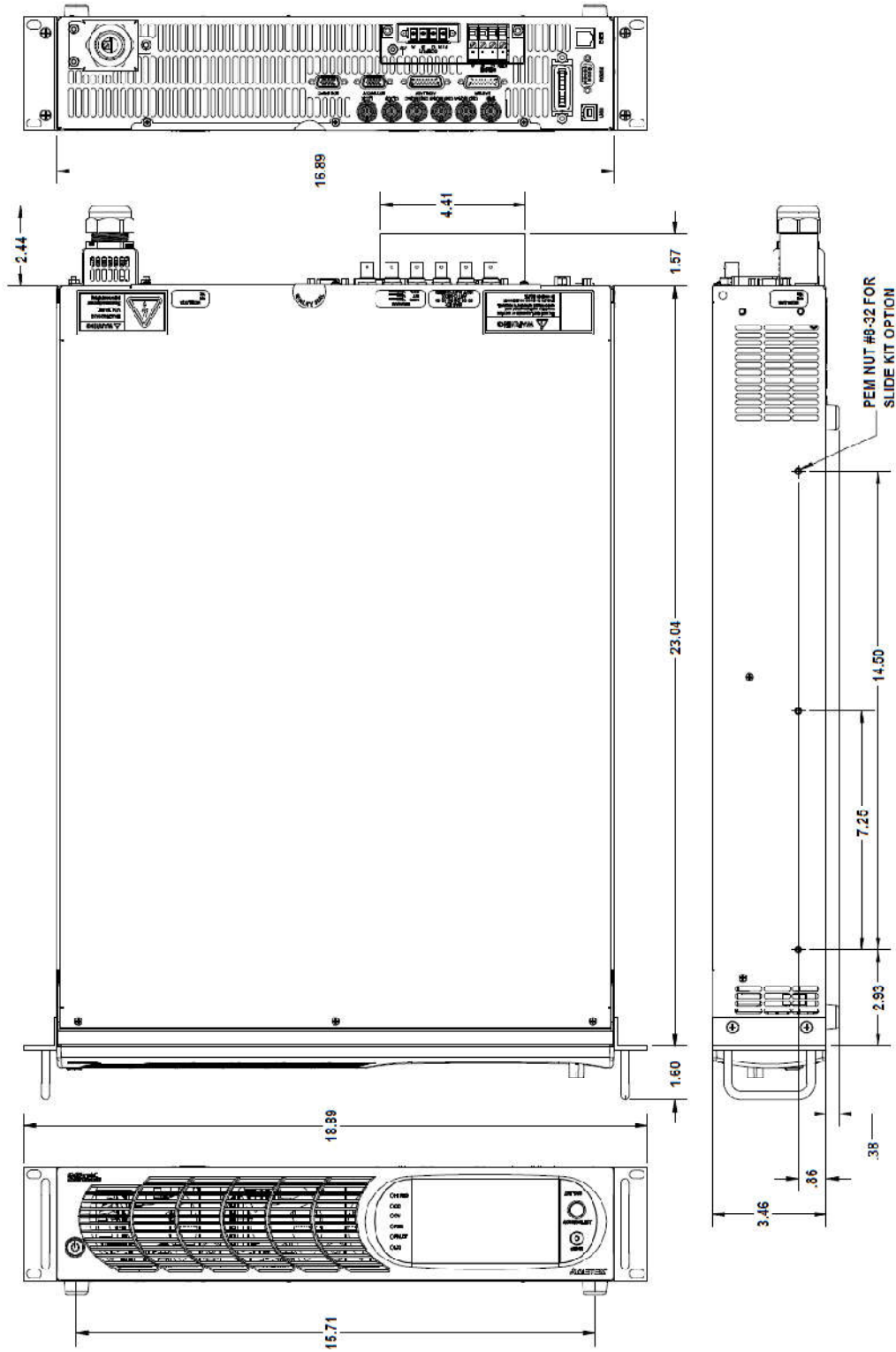

Figure 3-4. Installation Drawing, Enhanced 2U Models

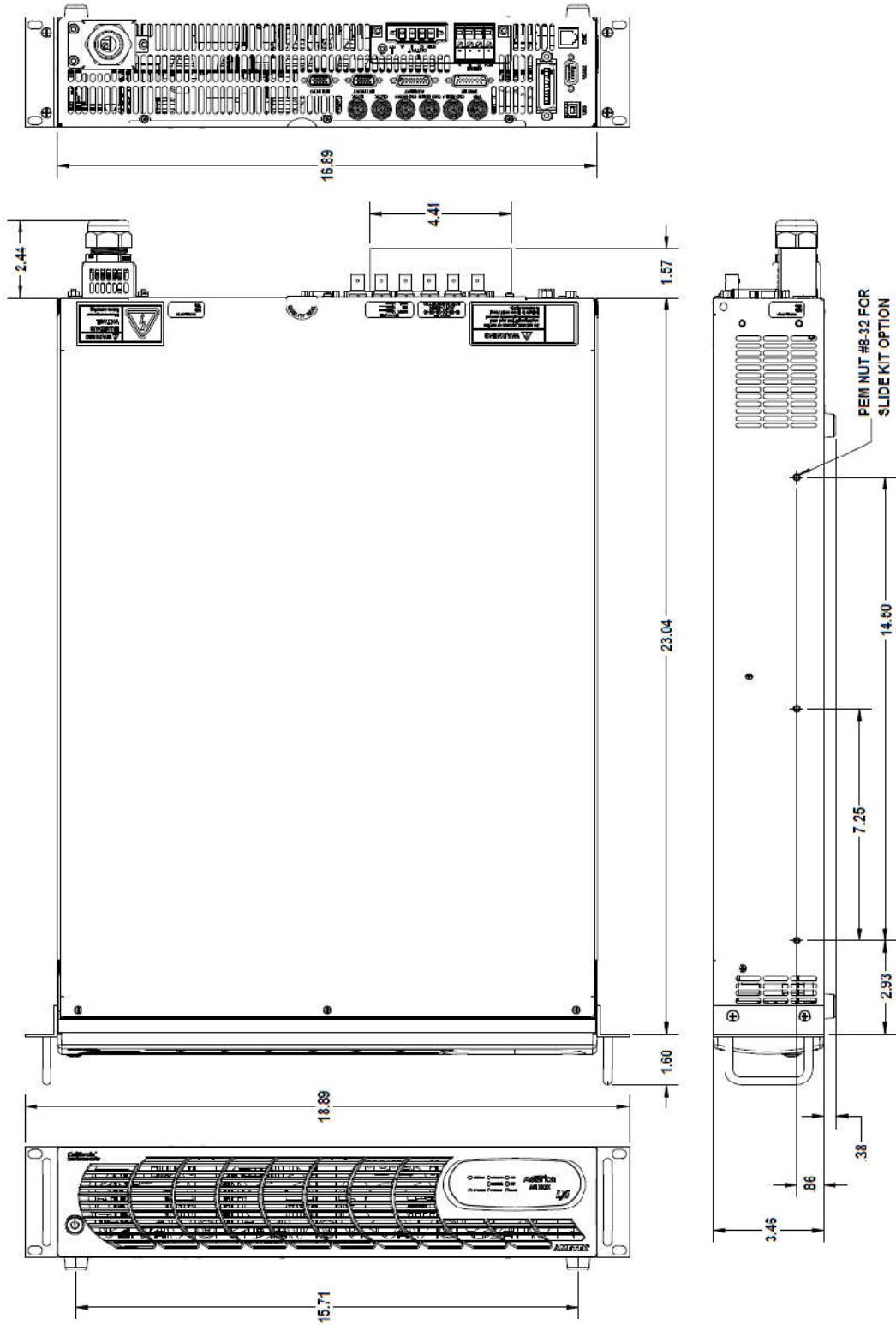

Figure 3-5. Installation Drawing, ATE 2U Models.

3.5 Input/Output Connections

Refer to Figure 3-6 for the rear panel view of the 2U model power source showing the location of the connectors.

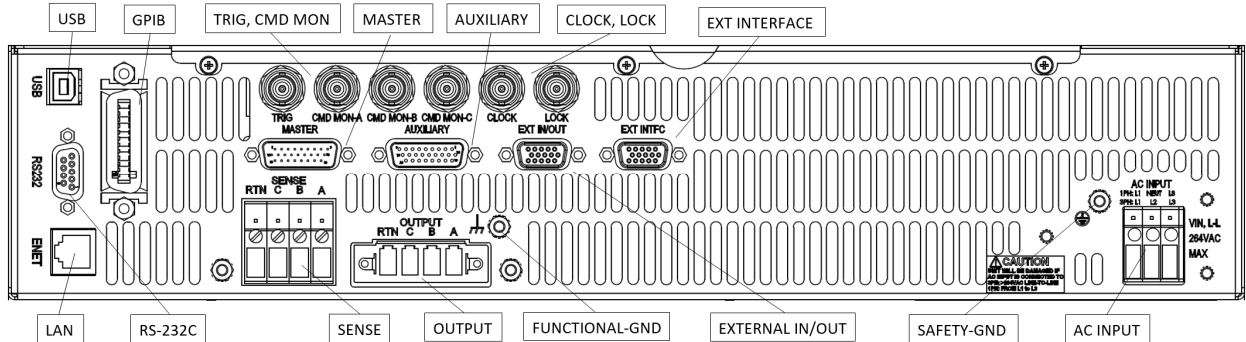

Figure 3-6. Rear Panel View, 2U Models, (with GPIB and LKM/LKS options)

	<p>WARNING!</p>
	<p>High voltage present at rear panel poses risk of electrical shock. The input and output covers must be installed in bench top applications to maintain protection against hazardous voltages. Do not remove protective covers on AC input or AC/DC output. Refer installation and servicing to qualified personnel.</p>
	<p>WARNING!</p>
	<p>The input and output voltages at the rear panel of the unit are HAZARDOUS LIVE. When rack mounting or panel-mounting the unit, suitable safeguards must be taken by the installer to ensure that HAZARDOUS LIVE voltages are not accessible.</p>
	<p>WARNING!</p>
	<p>Capacitors in the power source might hold a hazardous electrical charge even if the power source has been disconnected from the AC mains supply. Allow capacitors to discharge to a safe voltage before touching exposed pins of mains supply connector.</p>
	<p>WARNING!</p>
	<p>A safety disconnect device for the AC mains input must be installed so that it is readily accessible to the operator.</p>
	<p>WARNING!</p>
	<p>A properly sized input overcurrent protection device must be installed at the AC mains input. It could be either a circuit breaker or fuse having a rating of 25% over the maximum AC input line currents listed in the specifications of Section 2.1.3.</p>
	<p>WARNING!</p>
	<p>To prevent an electrical shock hazard, a safety ground wire must be connected from the safety-ground stud on the rear panel to the AC mains earth protection-ground</p>

3.6 AC Input Connection

The Asterion Series power source is designed to operate from 1-phase or 3-phase input power, having 2-wire/3-wire plus ground, with nominal AC input voltage of 100/115/230/240 VAC, and 50/60/400 Hz input frequency. The AC input voltage range is automatically selected by the unit at power-up; no user setup is required. Power factor correction (PFC) provides high power factor, minimizing the required input apparent power and current harmonic distortion. Refer to the specifications of Section 2.1.3 for AC input current requirements, and derating of output power as a function of AC input voltage.

3.6.1 AC Input Overcurrent Protection

The Asterion Series power source has fuses at the AC input for fault protection. These fuses are internal to the chassis and are not user accessible. They provide fault isolation in case a failure occurs of internal components or wiring. A suitable overcurrent protection device must be provided externally, within the system installation, to protect the external wiring and interconnects.

3.6.2 AC Input Safety Disconnect Device

The Asterion Series power source front panel POWER switch does not disconnect the AC input line from the unit. Ensure that an appropriately rated safety disconnect device is incorporated in the installation that will provide isolation from the AC input when the device is opened. The device could be a switch or circuit breaker, and must be located close to the unit, within reach of the operator, and clearly labeled as the disconnection device.

3.6.3 AC Input Connector

The AC input connector, AC INPUT, is located on the rear panel, along with the safety-ground stud. Figure 3-7 shows the rear panel view of the connector and study. Table 3-1 shows the functions and connector pinout, and Table 3-2 the connector type. A 1-Phase input is connected to terminals L1/L2 or L2/L3 (do not connect a 1-Phase input between L1/L3), while a 3-Phase input is connected to L1/L2/L3 (a connection to neutral is not utilized with 3-Phase input). The connector has compression terminals with female contacts. A ground connection must always be made to the utility earth protection-ground using the rear panel safety-ground stud.

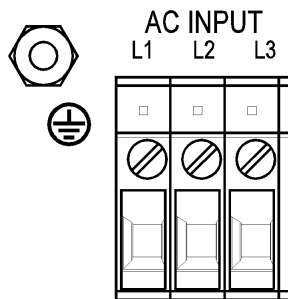



Figure 3-7. AC Input Connector and Safety-Ground Stud



WARNING! Do not connect a 1-Phase input between L1 and L3. This could produce a condition where internal damage might occur.

Name	Type	Range	Function
AC INPUT L1	AC Input	90-264 VAC	Line-1 input from utility AC mains; For 1-Phase input, connect lines to terminals L1 and L2, or L2 and L3; connection from L1 to L3 is not allowed.
AC INPUT L2	AC Input	90-264 VAC	Line-2 input from utility AC mains. For 1-Phase input, connect lines to terminals L1 and L2, or L2 and L3; connection from L1 to L3 is not allowed.
AC INPUT L3	AC Input	90-264 VAC	Line-3 input from utility AC mains; For 1-Phase input, connect lines to terminals L1 and L2, or L2 and L3; connection from L1 to L3 is not allowed.
GND	Safety Ground	N/A	Safety-Ground connection from utility earth protection-ground.

Table 3-1. AC Input Connector Pinout and Safety-Ground

Connector	Type
AC Input	Phoenix P/N 1703050; 3-position, compression terminals; wire stripping length: 14 mm (0.55"); tightening torque: 0.5 Nm, min (4.4 lb.-in) to 0.6 Nm, max (5.3 lb.-in); wire cross section: 0.5 mm ² , min (20 AWG) to 6 mm ² , max (10 AWG).
Safety-Ground	M4-0.7 x 7 stud; nut tightening torque, 1.1 Nm (10 lb.-in), max.

Table 3-2. AC Input Connector Type

3.6.4 1-Phase AC Input Operation

Connect the utility AC mains wires to the rear panel AC input connector terminals, L1/L2 or L2/L3; do not connect to L1/L3. Ensure that the voltage does not exceed 264 VAC. The power source does not require a neutral connection, so the input could be between any two lines that have a voltage that does not exceed 264 VAC. Use wires with ratings equal to or greater than the current rating listed in the specifications of Section 2.1.3. A ground wire must be connected from the rear panel safety-ground terminal to the utility power earth protection-ground.

3.6.5 3-Phase AC Input Operation

Connect the utility AC source wires to the rear panel AC input connector terminals, L1/L2/L3; a neutral connection is not required. Use wires with ratings equal to or greater than the current rating listed in the specifications of Section 2.1.3. A ground wire must be connected from the rear panel safety-ground terminal to the utility power distribution earth protection-ground.



CAUTION!

The maximum input voltage is 264 VAC, line-to-line, for 1-Phase or 3-Phase inputs. Exceeding the maximum AC input voltage could result in damage to the unit.

3.7 AC/DC Output Connection

The AC/DC Output connector provides terminations for the output and remote sense connections to the load. A chassis functional ground connection is provided adjacent to the connector to terminate cable shields, if used. Refer to Figure 3-8 for a view of the connector, Table 3-3 for the pinout and functions, and Table 3-4 for the connector type.

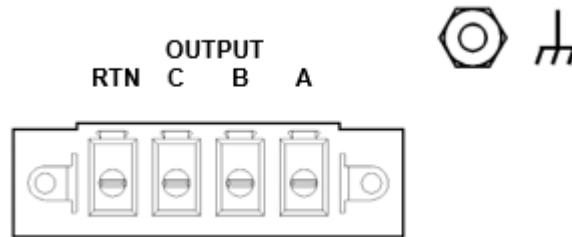

Figure 3-8. AC/DC Output Connector and Functional-Ground

Name	Type	Range	Function
Phase-A LINE	Output	0-200/400 VAC; 0V to $\pm 250/500$ VDC	Connection of AC/DC output Phase-A; total output of unit when 1-Phase operation is selected. (Note: Automatically connected internally to Phase-B and Phase-C when 1-Phase operation is selected, and for model ST 3001).
Phase-B LINE	Output	0-200/400 VAC; 0V to $\pm 250/500$ VDC	Connection of AC/DC output Phase-B (Note: Automatically connected internally to Phase-A and Phase-C when 1-Phase operation is selected, and for model AST 3001).
Phase-C LINE	Output	0-200/400 VAC; 0V to $\pm 250/500$ VDC	Connection of AC/DC output Phase-C (Note: Automatically connected internally to Phase-A and Phase-B when 1-Phase operation is selected, and for model AST 3001).
Output RTN	Output	0-200/400 VAC; 0V to $\pm 250/500$ VDC	Connection of AC/DC output return
GND	Functional Ground	N/A	Connection to chassis for functional-ground, such as termination of cable shields

Table 3-3. AC/DC Output Connector Pinout and Functional-Ground

Connector	Type
AC/DC Output	Connector header: Phoenix P/N 1720819; 4-position, compression terminals; Making connector: Phoenix P/N 1777859; compression terminals; housing retained to header with screws; wire stripping length: 10 mm (0.39"); tightening torque: 0.5 Nm, min (4.4 lb.-in) to 0.8 Nm, max (7 lb.-in); tightening torque for $\leq 4 \text{ mm}^2$ is 0.5-0.6 Nm, $> 4 \text{ mm}^2$ is 0.7-0.8 Nm; wire cross section: 0.2 mm^2 , min (24 AWG) to 6 mm^2 , max (10 AWG).
Functional-Ground	M4-0.7 x 7 mm stud; nut tightening torque, 1.1 Nm (10 lb.-in), max.

Table 3-4. AC/DC Output Connector Type and Functional-Ground

3.8 Remote Sense Connection

The Remote Sense connector provides terminations for the output remote sense connections to the load. Refer to Figure 3-8 for a view of the connector, Table 3-3 for the pinout and functions, and Table 3-4 for the connector type.

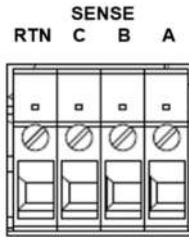

Figure 3-9. Remote Sense Connector and Functional-Ground

Name	Type	Range	Function
Sense-A	Input	0-400 VAC; 0V to ± 500 VDC	Remote sense connection for output voltage of Phase-A or 1-Phase output-mode
Sense-B	Input	0-400 VAC; 0V to ± 500 VDC	Remote sense connection for output voltage of Phase-B
Sense-C	Input	0-400 VAC; 0V to ± 500 VDC	Remote sense connection for output voltage of Phase-C
Sense RTN	Input	0-400 VAC; 0V to ± 500 VDC	Remote sense return connection for output voltage

Table 3-5. Remote Sense Connector Pinout

Connector	Type
Remote Sense	Phoenix P/N 1703034; 4-position, compression terminals; wire stripping length: 14 mm (0.55"); tightening torque: 0.5 Nm, min (4.4 lb.-in) to 0.6 Nm, max (5.3 lb.-in); wire cross section: 0.5 mm^2 , min (20 AWG) to 6 mm^2 , max (10 AWG).

Table 3-6. Remote Sense Connector Type

3.9 Remote Sense

Output voltage sensing is user-selectable to be either local sense or remote sense. Sensing provides the signal for measurement of the output voltage and determines the physical point where the output voltage is precisely regulated. Local sense is at the rear panel output connector, while remote sense is at the load, through a cable connection from the rear panel remote sense connector. An internal relay is used to select which sense signal is used by the controller.

Remote sensing is used to compensate for the voltage drop that occurs across the wires connecting the load to the output of the power source. A separate pair of wires is routed to measure the voltage at the terminals of the load where precise regulation of the output voltage is desired. The remote sense leads are connected to the Remote Sense connector on the rear panel; refer Figure 3-7. Connect the terminals, Sense Phase-A/B/C, to the points at the load that are connected to the Output Phase-A/B/C LINE terminals, and the terminal, Sense RTN, to the point at the load that is connected to Output RTN terminal.

Special care is required in routing the sensing leads to prevent noise pickup or coupling to the power leads; refer to Section 3.10. The sense leads should be a twisted pair of at least AWG #22 wire and may require shielding in high noise environments. If a shield is used, connect it to the functional-ground terminal at the AC/DC Output connector location.

If the remote sense leads are not connected, but remote sense has been selected, the AC source will continue to operate but the voltage at the load will no longer be precisely regulated. An internal circuit exists within the unit that provides redundant voltage sensing from the output terminals, in case the remote sense leads are not connected. However, this condition does not have voltage calibration, and since the voltage is now measured at the output terminals, the voltage drop of the load wiring would no longer be compensated.

Two conditions related to remote sensing are treated as faults and result in shutdown of the output: short-circuiting of the remote sense terminals or connecting the remote sense leads in reverse polarity. When the fault condition is detected, shutdown will result with the output voltage being programmed to zero and the output isolation relays being opened.

3.10 Noise and Impedance Effects

To minimize noise pickup or radiation from load circuits, load wires and remote sense wires should be twisted pair and have minimum lead length. Shielding of the sense leads may be necessary in high noise environments. Even if noise is not a concern, the load and remote sense wires should be twisted-pairs to reduce coupling between them, which could impact the stability of the output amplifier. Twisting the load wires provides an additional benefit in reducing the parasitic inductance of the cable. This improves the dynamic response characteristics at the load by maintaining low source impedance at high frequencies. If connectors are utilized for power and sense leads, consideration of routing is necessary to minimize coupling between the leads. Ensure that the connector terminals for the sense leads are in adjacent contact locations and minimize the physical loop area of the untwisted portions.

3.11 Wire Gauge Selection

Care must be taken to properly size all conductors for the input and output of the power source. This section provides guidance in the selection of wire size.



CAUTION! Use wire with Class B or C stranding. Fine-stranded (flexible) wire should not be used unless crimp-on lugs or ferrules are utilized that are approved for fine-stranded cables

3.11.1 Wire Size

The tables below will assist in determining the appropriate wire size for both the input and output connections. Table 3-7 gives minimum recommended wire size; these recommendations are for 30°C ambient, and for copper wire only. This table is derived from the National Electrical Code and is for reference only. Local laws and conditions may have different requirements. For higher ratings, wires can be parallel; refer to the National Electrical Code for guidelines.

Size	Temperature Rating of Copper Conductor		
	60°C	75°C	90°C
AWG	Types : TW, UF	Types: RHW, THHW, THWN, XHHW, USE, ZW	Types : TBS SA, SIS, FEP, FEPB, MI, RHH, THHN, THHW, XHH, XHHW
	Current Rating, A(RMS)		
18	–	–	14
16	–	–	18
14	15	20	25
12	20	25	30
10	30	35	40
8	40	50	55
6	55	65	75
4	70	85	95
3	85	100	115
2	95	115	130
1	110	130	145
0	125	150	170
00	145	175	195
000	165	200	225
0000	195	230	260

Table 3-7. Minimum Wire Size

When determining the optimum cable specification for your power applications, the same engineering rules apply whether at the input or output of an electrical device. Therefore, this guide applies equally to the input cable and output cable for this power source and application loads.

Power cables must be able to safely carry maximum load current without overheating or causing insulation degradation. It is important to power source performance to minimize IR (voltage drop) loss within the cable. These losses have a direct effect on the quality of power delivered to and from the power source and corresponding loads.

When specifying wire gauge, consider derating due to operating temperature at the wire location. Wire gauge current capability and insulation performance drops with the increased temperature developed within a cable bundle and with increased environmental temperature. Therefore, short cables with derating of gauge size and insulation properties are recommended for power source applications.

Be careful when using published commercial utility wiring codes. These codes are designed for the internal wiring of homes and buildings and accommodate the safety factors of wiring loss, heat, breakdown insulation, aging, etc. However, these codes consider that up to 5% voltage drop is acceptable. Such a loss directly detracts from the performance specifications of this power source. Also, consider how the wiring codes apply to bundles of wire within a cable arrangement.

In high performance applications requiring high inrush/ transient currents, additional consideration is required. The cable wire gauge must accommodate peak currents developed at peak voltages, which might be up to five times the RMS current values. An underrated wire gauge adds losses, which alter the inrush characteristics of the application and thus the expected performance.

Table 3-8 presents wire resistance and resulting cable voltage drop at maximum rated current, with the wire at 20°C. Copper wire has a temperature coefficient of $\alpha = 0.00393\Omega/^{\circ}\text{C}$ at $t_1 = 20^{\circ}\text{C}$, so that at an elevated temperature, t_2 , the resistance would be $R_2 = R_1 (1 + \alpha (t_2 - t_1))$.

The output power cables must be large enough to prevent the line voltage drop (total of both output wires) between the power source and the load from exceeding the remote sense capability as presented in the specification section. Calculate the voltage drop using the following formula:

$$\text{Voltage Drop} = 2 \times \text{distance-in-feet} \times \text{cable-resistance-per-foot} \times \text{current}$$

Size, AWG	A(RMS), (90°C wire)	Ohms/100 Ft, (One Way)	Voltage Drop/100 Ft, (Column 2 x Column 3)
18	14	0.639	8.95
16	18	0.402	7.24
14	25	0.253	6.33
12	30	0.159	4.77
10	40	0.100	4.00
8	55	0.063	3.47
6	75	0.040	3.00
4	95	0.025	2.38
3	115	0.020	2.30
2	130	0.016	2.08
1	145	0.012	1.74
0	170	0.0098	1.67
00	195	0.0078	1.52
000	225	0.0062	1.40
0000	260	0.0049	1.27

Table 3-8. Wire Resistance and Voltage Drop, 20°C

3.12 Rear Panel User Interface Connectors

The rear panel contains connectors for the remote analog and discrete-digital control interfaces, master/auxiliary unit interface, the digital communications interfaces (LAN, USB, RS-232C, and optional IEEE-488), and the external interface.

3.12.1 External Input/Output Control Signal Connector

The External Input/Output connector, EXT IN/OUT, is located on the rear panel. Figure 3-10 shows the rear panel view of the connector, and Table 3-9 External Input/Output Control Connector Type lists the connector type. Table 3-10 shows the functions and Table 3-11 shows the connector pinout.

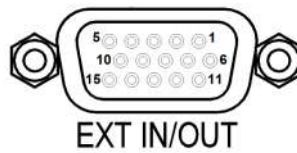

Figure 3-10. External Input/Output Control Connector

Connector	Type
External Input/Output Control	High-density, 15-socket, receptacle (female) Subminiature-D.

Table 3-9. External Input/Output Control Connector Type

Function	Characteristics
External Analog Programming of Output Voltage Waveform	<p>Signal inputs for output voltage waveform programming by external analog reference; individual inputs provided for each output phase.</p> <p>AC or DC input signals: 0V to user-selectable maximum range value within ± 2.5 V(PK) to ± 10 V(PK), corresponding to maximum range of 1.77 V(RMS) to 7.07 V(RMS), for zero to full-scale RMS output voltage; with AC waveform, from 16 Hz to 5 kHz (option dependent); programming accuracy, $\pm 2\%$ of full-scale output; input impedance, 40 kΩ, typical; safety isolation SELV-rated, referenced to chassis;</p> <p>This function has the same connector pin connection as the signal, External Analog Programming of Output Voltage Amplitude; that pin is user selectable as to which function is provided.</p>
External Analog Programming of Output Voltage Amplitude (RPV)	<p>Signal inputs for output voltage amplitude programming of waveform that is set by internal controller reference; individual inputs provided for each output phase.</p> <p>DC input signal: 0V to user-selectable maximum range value within 2.5 VDC to 10 VDC, for zero to full-scale RMS of internally programmed output voltage waveform; programming accuracy, $\pm 2\%$ of full-scale output; input impedance, 40 kΩ, typical; safety isolation SELV-rated, referenced to chassis;</p> <p>This function has the same connector pin connection as the signal, External Analog Programming of Output Voltage Waveform; that pin is user selectable as to which function is provided.</p>
External Analog Modulation of Output Voltage	<p>Signal input for output voltage modulation of waveform set by internal controller reference; individual inputs provided for each output phase.</p> <p>AC or DC input signal range: 0V to ± 7.07 V(PK), 0-5 V(RMS) for 0-20% of full-scale output voltage amplitude modulation; programming accuracy, $\pm 2\%$ of full-scale output; input impedance, 40 kΩ, typical; safety isolation SELV-rated, referenced to chassis.</p>
Trigger Input	<p>Signal input of external trigger for execution of programmed values or transient lists; logic level, TTL-compatible;</p> <p>isolated connection with signal return common to the signals, Synchronization Signal and Remote Inhibit; safety isolation SELV-rated, referenced to ISO_COM (refer to Table 3-11).</p>
Synchronization Signal (SYNC) Input	<p>Signal input for external square wave to control the output frequency and phase, with the waveform generated by the internal reference;</p> <p>logic level, TTL-compatible; logic-high-going edge synchronized with positive-going alternation of output waveform;</p> <p>isolated connection with signal return common to the signals, Trigger Input and Remote Inhibit; safety isolation SELV-rated, referenced to ISO_COM (refer to Table 3-11).</p>
Remote Inhibit Input	<p>Signal input to turn the output off/on; logic level, TTL-compatible; user-selectable for active-high or active-low;</p> <p>isolated connection with signal return common to the signals, Synchronization Clock and Trigger Input; safety isolation SELV-rated, referenced to ISO_COM (refer to Table 3-11).</p>
Summary Fault Switch Output	<p>Switch output indicating that a Summary Fault (DFI) condition is present;</p> <p>normally closed, bidirectional AC/DC solid-state switch;</p> <p>closed-circuit for fault or when unit is turned off (open circuit for no fault present);</p> <p>switch ratings: ± 12V, maximum peak voltage; 0.1A, maximum current; 2.5Ω, maximum closed resistance; 6A, maximum open-circuit leakage current at 12V;</p> <p>connection isolated from all other signals, floating switch output;</p> <p>safety isolation SELV-rated.</p>

Table 3-10. External Input/Output Control Functions

Pin #	Name	Type	Range	Function
1	REFERENCE-A	Analog Input	±10V	Analog programming signal input terminal for user-selectable external waveform programming or amplitude control (RPV) for Phase-A.
2	REFERENCE-B	Analog Input	±10V	Analog programming signal input terminal for user-selectable external waveform programming or amplitude control (RPV) for Phase-B.
3	REFERENCE-C	Analog Input	±10V	Analog programming signal input terminal for user-selectable external waveform programming or amplitude control (RPV) for Phase-C.
4	REFERENCE RETURN	Signal Return	Return	Analog programming signal return terminal.
5	MODULATION-A	Analog Input	±7.07V	External modulation signal input terminal for Phase-A.
6	MODULATION-B	N/A	N/A	External modulation signal input terminal for Phase-B.
7	MODULATION-C	N/A	N/A	External modulation signal input terminal for Phase-C.
8	MODULATION RETURN	Signal Return	Return	External modulation signal return terminal.
9	ISO_COM	Return	Return	Isolated signal return terminal for signals on Pin-12 and Pin-13; connected to Pin-11 through 10 Ω; isolated from Pins1-8 and Pins14-15.
10	SYNC_HIGH	Digital Input	0-5V	Isolated signal for synchronization of the output to a logic-high signal transition; paired with Pin-11; isolated from Pins1-8 and Pins14-15.
11	SYNC_LOW	Return	Return	Isolated signal return for synchronization of the output; paired with Pin-10; connected to Pin-9 through 10 Ω; isolated from Pins1-8 and Pins14-15.
12	INHIBIT	Digital Input	0-5V	Isolated inhibit signal to turn the output off/on and open/close the output relay; signal return on Pin-9; isolated from Pins1-8 and Pins14-15.
13	TRIGGER	Digital Input	0-5V	Isolated trigger signal; signal return on Pin-9; isolated from Pins1-8 and Pins14-15.
14	SUMMARY FAULT-1	Switch Output	±12V	Isolated Summary Fault (DFI) signal; paired with Pin-15; isolated from Pins1-13; refer to Table 3-10.
15	SUMMARY FAULT-2	Switch Output	±12V	Isolated Summary Fault (DFI) signal return; paired with Pin-14; isolated from Pins1-13; refer to Table 3-10.

Table 3-11. External Input/Output Control Connector Pinout

3.12.2 Summary Fault Signal (DFI)

The Summary Fault (DFI) signal, SUMMARY FAULT-1 (Pin-14) and SUMMARY FAULT-2 (Pin-15), provides an indication of abnormal condition occurrence. In the default configuration, the signal reports the summary bit that is the logic-OR of the Questionable Status Register outputs for the following events:

- a. PFC Module fault: summary state of overtemperature, input undervoltage, overload;
- b. DC Module fault: summary state of overtemperature, output overvoltage, driver fault;
- c. AC Module fault: summary state of overtemperature, DC bus under/overvoltage, inverter peak current limit, logic power undervoltage;
- d. Overtemperature fault: AC Module overtemperature;
- e. Output overvoltage fault;
- f. Output voltage regulation fault;
- g. Output current-limit fault.

The functionality of the Summary Fault signal could be programmed through SCPI commands to report events as captured in either of the following sources: Questionable Status Register (default setting), Operation Status Register, Standard Event Status Register, or Request Service Summary Bit. Also, the Summary Fault signal operation could be enabled and disabled through SCPI commands. Refer to the Asterion Series SCPI Programming Manual, M330100-01, for specific information on the programming options; it is referred to as the Discrete Fault Indicator (DFI) signal in that manual.

3.12.3 Remote Inhibit Signal

The Remote Inhibit signal, /INHIBIT_ISO (Pin-12), can be used to turn the output on/off and close/open the output relay of the power source. When set to the off state, this input overrides the output state programmed through the front panel or the remote digital interface.

The default logic-level for Remote Inhibit is a logic-low or contact closure between /INHIBIT_ISO (Pin-12) and ISO_COM (Pin-9). This will cause the output voltage to be programmed to zero volts and the output relays to open. This logic-level could also be selected with the SCPI command, OUTPUT:RI:LEVEL LOW.

Alternatively, the logic-level could be changed by the user to logic-high using the remote digital interface SCPI command, OUTPUT:RI:LEVEL HIGH. A logic-high or open-circuit between /INHIBIT_ISO (Pin-12) and ISO_COM (Pin-9) will cause the output voltage to be programmed to zero volts and the output relays to open.

The mode of operation of the Remote Inhibit can be changed using the remote digital interface SCPI command, OUTP:RI:MODE <mode>. The following modes can be selected:

- LATC(hing)** A TTL logic-low (or user-selected logic-high) at the Remote Inhibit input latches the output in the protection shutdown state; this state could only be cleared by the remote digital interface SCPI command, OUTPut:PROTEction:CLEAr.
- LIVE** The output state follows the state of the Remote Inhibit input. A TTL logic-low (or user-selectable logic-high) at the Remote Inhibit input turns the output off; a TTL logic-high (or user-selectable logic-low) turns the output on.
- OFF** The power source ignores the Remote Inhibit input.

The Remote Inhibit output mode state is saved at power-down. The factory default state is LIVE. For additional information on programming the Remote Inhibit function, refer to the Asterion Programming Manual P/N M330100-01 distributed on the CD, CIC496. Refer to AMETEK Programmable Power website, www.programmablepower.com, to download latest version.

3.12.4 External Interface Signal Connector

The External Interface connector, EXT INTFC, is located on the rear panel Figure 3-11 shows the rear panel view of the connector, and Table 3-12. External Interface Signal Connector Type lists the connector type. This connector provides a dedicated interface with an extension chassis and does not have any signals that are to be utilized by the user.

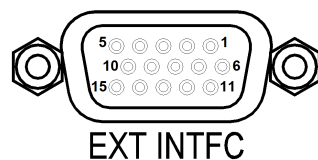

Figure 3-11. External Interface Signal Connector

Connector	Type
External Interface	High-density, 15-socket, receptacle (female) Subminiature-D.

Table 3-12. External Interface Signal Connector Type

3.12.5 Command Monitor and Trigger Output Connectors

The connectors for the Command Monitors, CMD MON-A, CMD MON-B, CMD MON-C, and Trigger Output, TRIG, signals are BNC-type located on the rear panel; refer to Figure 3-12 for view of connectors and Table 3-13 for descriptions. The CMD MON connectors provide signal outputs for sensing the waveforms of the internal voltage command signals that are being applied to the power amplifiers of the three output phases. The TRIG connector provides a signal output synchronized with changes in programmed value or transient lists.

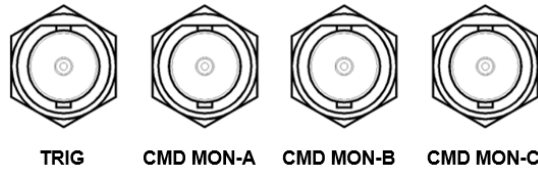

Figure 3-12. External Command Monitor and Trigger Output Connectors

Function	Characteristics
Output Command Monitor-A, Monitor-B, Monitor-C	Signal outputs for monitoring the waveforms of the voltage command signals of the output amplifiers; individual outputs are provided for each output phase. 0 -5 V(RMS), typical, signal range for zero to full-scale output voltage; individual rear panel BNC connector; Safety isolation SELV-rated, referenced to chassis.
Trigger Output	Signal output with dual function: user selectable as either function trigger or list trigger; function trigger provides a pulse for any programmable change in output voltage or frequency; list trigger provides a pulse if programmed as part of list transients; logic level, active-low pulse with duration of 550 μ s, typical; individual rear panel BNC connector; Safety isolation SELV-rated, referenced to chassis.

Table 3-13. External Command Monitors and Trigger Output Characteristics

3.12.6 Clock and Lock Connectors (Option)

The connectors for the Clock signal, CLOCK, and Lock signal, LOCK, are BNC-type located on the rear panel; refer to Figure 3-13 for view of connectors and Table 3-14 for descriptions. These connectors are only available with the LKM or LKS options. These options are used to synchronize and control the phase shift of the output voltage of Auxiliary power sources in relation to the output of the Master power source. The frequency of the Auxiliary power sources is determined by the frequency of the Master source through the CLOCK signal; the phase is determined by the LOCK signal. Figure 3-13 shows an example of CLOCK and LOCK connections in a multi-phase system comprised of three power sources.

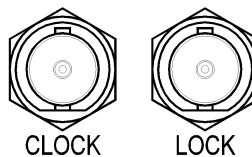

Figure 3-13. External Clock/Lock Interface Connectors (Option)

Function	Characteristics
LKM (Option)	Signal outputs in Master unit for Clock and Lock that are used to synchronize two or more AC sources; CLOCK sets the frequency, while LOCK sets the phase; logic level, TTL-compatible; individual rear panel BNC connectors for each signal; safety isolation SELV-rated, referenced to chassis.
LKS (Option)	Signal inputs in Auxiliary units for Clock and Lock that are used to synchronize two or more AC sources; CLOCK sets the frequency, while LOCK sets the phase; logic level, TTL-compatible; individual rear panel BNC connectors for each signal; safety isolation SELV-rated, referenced to chassis.

Table 3-14. External Clock/Lock Interface Characteristics (Option)

3.12.7 Master/Auxiliary System Interface Connectors

The Master connector, MASTER, and Auxiliary connector, AUXILIARY, are used to connect Auxiliary power sources to the Master power source for operation in parallel, multi-chassis systems; refer to Figure 3-14 for view of connectors, with Table 3-15 and Table 3-16 for descriptions. The Master/Auxiliary interface signals are dedicated to the control of parallel-group operation and are not to be utilized by the user.

The power source that is to be the Master will have the System Interface cable plugged into its connector labeled MASTER. The other end of the System Interface cable will plug into the connector labeled AUXILIARY in the first Auxiliary power source comprising the system. Additional Auxiliary power sources would be chained together with System Interface cables connecting the MASTER connector of one unit to the AUXILIARY connector of the next unit in the chain. Refer to Figure 3-14 for an example of a parallel system comprised of three units.

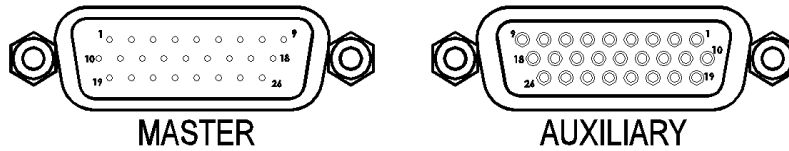

Figure 3-14. External Master/Auxiliary System Interface Connectors

Connector	Type
Master	High-density, 26-pin, plug (male) Subminiature-D.
Auxiliary	High-density, 26-socket, receptacle (female) Subminiature-D.

Table 3-15. External Master/Auxiliary System Interface Connector Type

Function	Characteristics
Master Interface	Control signal interface on Master unit (or other Auxiliary unit if more than two units comprise the parallel group) going to Auxiliary unit for multi-chassis parallel operation; Connector: high-density, 26-pin, male Subminiature-D; none of the signals are intended for interface with user equipment.
Auxiliary Interface	Control signal interface on Auxiliary unit coming from Master unit (or other Auxiliary unit if more than two units comprise the parallel group) for multi-chassis parallel operation; Connector: high-density, 26-pin, female Subminiature-D; none of the signals are intended for interface with user equipment.

Table 3-16. External Master/Auxiliary System Interface Characteristics

3.12.8 RS-232C Serial Interface Connector

RS-232C remote control interface is made through a 9-contact Subminiature-D connector located on the rear panel; refer to Figure 3-15 for view of connector and Table 3-17 with Table 3-18 for descriptions. The power source functions as Data Circuit-terminating Equipment (DCE). The cable connecting to the Data Terminal Equipment (DTE) should be straight-through (one-to-one contact connections).

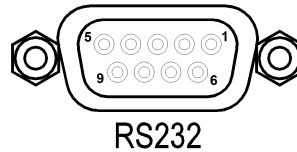

Figure 3-15. RS-232C Interface Connector

Connector	Type
RS-232C Interface	9-contact receptacle (female) Subminiature-D.

Table 3-17. RS-232C Interface Connector Type

Pin #	Name	DCE Signal	Direction
1	N/C	N/A	N/A
2	TxD	Transmit Data	Output
3	RxD	Receive Data	Input
4	N/C	N/A	N/A
5	Common	N/A	N/A
6	N/C	N/A	N/A
7	RTS	Request To Send	Input
8	CTS	Clear To Send	Output
9	N/C	N/A	N/A

Table 3-18. RS-232C Interface Connector Pinout

3.12.9 USB Interface

USB remote control interface is made through a Series-B device connector located on the rear panel; refer to Figure 3-16 for view of connector and Table 3-19 and Table 3-18 for descriptions. A standard USB cable between the Asterion Series power source and a computer should be used.



CAUTION! Connecting the power source to the computer controller through a USB hub is not recommended. The USB connection should be direct between the two devices.

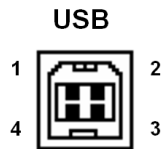

Figure 3-16. USB Interface Connector

Pin #	Name	Description
1	N/C	No Connection
2	D-	Data -
3	D+	Data +
4	GND	Ground

Table 3-19. USB Interface Connector Pinout

3.12.10 LAN Interface (Ethernet)

A LAN connector (Ethernet 10BaseT/100BaseT) is located on the rear panel for remote control; refer to Figure 3-17 for view of connector and Table 3-20 and Table 3-18 for descriptions. A standard modular cable with an 8P8C modular plug should be used between the power source and a network hub. For a direct connection to a computer LAN card, a crossover cable with an 8P8C modular plug is required. The MAC Address (Media Access Control) of the Ethernet port is printed on a label on the chassis of the power source. For information on how to set up a network connection or a direct computer connection using the LAN interface, refer to the Asterion Series Programming Manual P/N M330100-01 distributed on the CD, CIC496. Refer to AMETEK Programmable Power website, www.programmablepower.com, to download latest version.

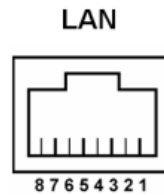

Figure 3-17. LAN Interface 8P8C Modular Connector

Pin #	Ethernet Signal	EIA/TIA 568A	EIA/TIA 568B Crossover
1	Transmit/Receive Data 0 +	White with green stripe	White with orange stripe
2	Transmit/Receive Data 0 -	Green with white stripe or solid green	Orange with white stripe or solid orange
3	Transmit/Receive Data 1 +	White with orange stripe	White with green stripe
4	Transmit/Receive Data 2 +	Blue with white stripe or solid blue	Blue with white stripe or solid blue
5	Transmit/Receive Data 2 -	White with blue stripe	White with blue stripe
6	Transmit/Receive Data 1 -	Orange with white stripe or solid orange	Green with white stripe or solid green
7	Transmit/Receive Data 3 +	White with brown stripe or solid brown	White with brown stripe or solid brown
8	Transmit/Receive Data 3 -	Brown with white stripe or solid brown	Brown with white stripe or solid brown

Table 3-20. LAN Interface 8P8C Modular Connector Pinout

3.13 Multiple Chassis System Configurations

The Asterion Series power source has the capability to be configured in multi-chassis groups with multiple-phase outputs using the optional Clock/Lock signal interface. The sources are individually programmed for output voltage/current, while the Clock/Lock interface ensures frequency and phase synchronization between units.

The power source could also be configured in parallel, multiple-chassis groups to extend the total output power. The outputs of the individual units must be connected in parallel, and a Master/Auxiliary System interface cable must interconnect them. The control interface of the units is automatically configured when the Master/Auxiliary System interface cable is connected, so no setting changes by the user are required.

3.13.1 Multi-Phase System

The connections to set up a multi-phase group of units require that the output lines, PHASE-A, PHASE-B, PHASE-C and RTN, are connected independently from each output of a unit to the load. If the remote sense is used, each unit must have it connected to the phase of the load at the point where precise regulation of the output voltage is desired.

The units must have the Clock/Lock options installed, with the Master unit having the LKM option and the Auxiliary units having the LKS option. The Clock/Lock connectors of the Master unit provide output signals: CLOCK to set the frequency, and LOCK to set the phase. The Clock/Lock connectors of the Auxiliary units are inputs to accept the control signals from the Master unit. The Clock and Lock interfaces are signal buses, so the Clock connectors of all units must be connected, and the Lock connectors must be connected together. Programming, readback, and control are done through the individual units. Also, the Auxiliary units must have their phase programmed in reference to the Master unit.

The clock source and configuration must be set for multi-phase operation through the remote digital interface using SCPI commands or the front panel display. Set up through the front panel is as follows:

1. In the CONFIGURATION, PONS CLOCK CONFIG display menu, the Master unit must have the configuration set to Master (the AC input must be cycled off/on for a change in a PONS setting to take effect); refer to Section 4.5.5;
2. In the CONFIGURATION, PONS CLOCK CONFIG display menu, the Auxiliary units must have the configuration set to Auxiliary (the AC input must be cycled off/on for a change in a PONS setting to take effect); refer to Section 4.5.5;
3. In the CONFIGURATION, CLOCK MODE display menu, the Auxiliary units must have the clock source set to External; refer to Section 4.5.5.

3.13.2 Parallel System

The connections to set up a parallel group of units require that the output lines PHASE-A, PHASE-B, PHASE-C and RTN are connected together from each unit to an external terminal block. If the remote sense is used, only the Master unit has it connected to the load at the point where precise regulation of the output voltage is desired; the Auxiliary units do not have remote sense connected. The Master/Auxiliary System Interface cable is connected from the Master unit connector, MASTER, to the Auxiliary unit connector, AUXILIARY. Additional Auxiliary units are connected from the Master connector of the last unit in the signal chain to the Auxiliary connector of following unit.

2U units of either 1500 W or 3000W rating could be connected in any combination to form a parallel group. Units with a 2250 W rating must be paralleled only to units with the same rating. All programming, readback, and control are done through the Master unit. The Master/Auxiliary interface is automatically configured so that the current reported by the Master unit is the sum of all units within the group. The

displays of the Auxiliary units are disabled, and show the message, “SOURCE IN AUXILIARY MODE No access to the user”.

When the parallel group system is powered up, the order of powering the Auxiliary sources and the Master source is not important. After the system is powered up, if an auxiliary power source is powered down there will be an error message displayed on the Master source, “Aux Down ensure all are powered up”. If power is reapplied to the Auxiliary source, the message will disappear, and normal operation could resume. If the Master/Auxiliary System Interface cable is removed from the Auxiliary source while the source is powered down, the error message will disappear, but the Master source will not have the correct configuration. The Master source must have its AC input power toggled, Off to On, for the correct configuration to be established.

4. Operation

The Asterion Series power source provides extensive functionality and programmability, which could be utilized through the front panel, remote digital interface, and the remote analog/digital control interface. The front panel includes a graphical, touch-screen display utilizing a menu-driven interface for simplified operation of the unit and quick access to the sophisticated functions. The remote interfaces provide expanded control capability and access to the full functionality of the source. The following sections provide detailed information on the controls and indicators, front panel menu structure, and remote digital interface programming conventions.

4.1 Front Panel Operation

Figure 4-1 shows a view of the front panel of the Enhanced models, while Figure 4-3 shows the front panel of the ATE models. Refer to Table 4-1 for functional descriptions of the Enhanced front panel, and Table 4-2 for functional descriptions of the ATE front panel.

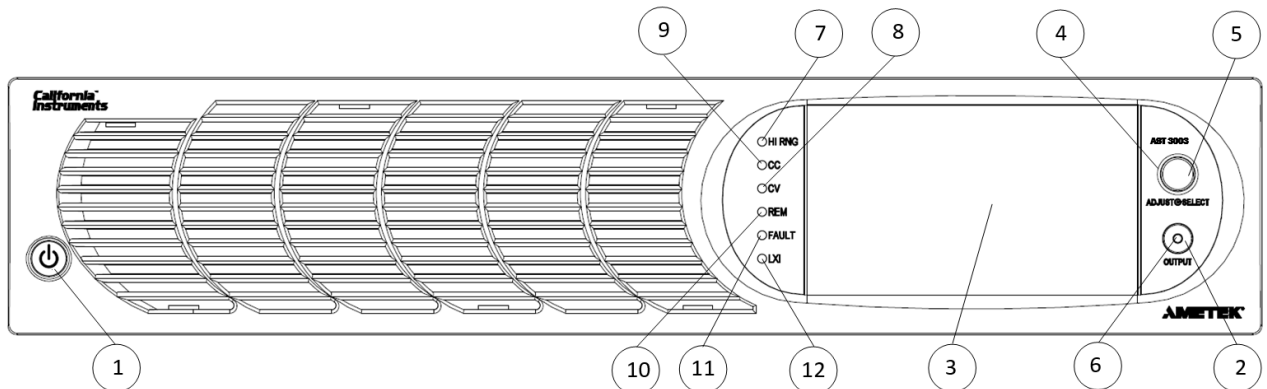

Figure 4-1. Front Panel, Enhanced 2U Models

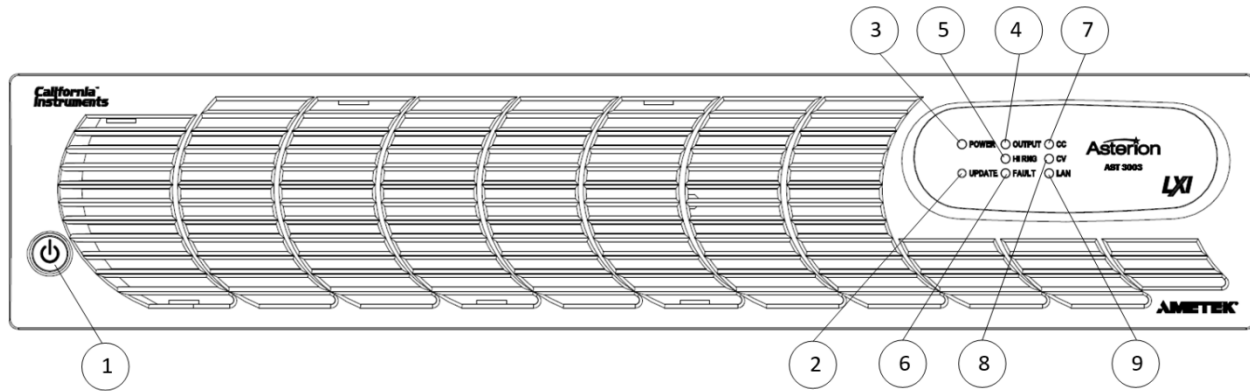

Figure 4-2. Front Panel, ATE 2U Models.

4.1.1 Front Panel Controls and Indicators, Enhanced 2U Models

Item	Reference	Functional Description
1	ON/OFF(Standby) Switch	<p>Two-position pushbutton switch turns the source on and off.</p> <div style="border: 1px solid black; padding: 5px;">  <p>WARNING! OFF position does not remove AC input from internal circuits. Disconnect external AC input before servicing unit</p> </div>
2	OUTPUT Switch	Momentary switch that toggles the output power ON/OFF, and closes/opens the output isolation relay.
3	Display	TFT color graphics display with backlight and pressure-actuated touch-screen; menu-driven settings and functions.
4	Rotary Encoder	Navigates between and within screens; scrolls through functions and selects numerical values; adjusts output parameters in real-time.
5	Rotary Encoder Switch	Momentary-action switch that selects functions and enters numerical values.
LED Mode Indicators		Indicates the mode that is active:
6	OUTPUT	Output is turned on; indicator is integral with the OUTPUT switch.
7	HI RNG	The output voltage is set to a high range.
8	CV	All output phases of the power source are presently in Constant-Voltage mode, and the output voltage is regulated.
9	CC	At least one of the output phases of the power source is presently in Constant-Current mode, and the output current of that output is regulated.
10	REM	<p>Source is presently controlled by the remote digital interface. If the RS-232C, USB or LAN interface is used, the REM state can be enabled by the external controller using the SCPI command, SYST:REM. If the optional IEEE-488 (GPIB) interface is used, this indicator will be lit whenever the REM line (REM ENABLE) line is asserted by the IEEE-488 controller.</p> <p>Any time the REM LED is lit, the front panel control of the unit is disabled. To regain control through the front panel, the external controller must send the SCPI command, SYST:LOC.</p>
11	FAULT	Fault condition has occurred; output is shutdown, isolation relay is open, and output voltage is programmed to zero.
12	LXI	LXI status annunciation.

Table 4-1. Front Panel Controls and Indicators, Enhanced 2U Models

4.1.2 Front Panel Controls and Indicators, ATE 2U Models

Item	Reference	Functional Description
1	ON/OFF(Standby) Switch	<p>Two-position pushbutton switch turns the source on and off.</p> <div style="border: 1px solid black; padding: 5px;">  <p>WARNING! OFF position does not remove AC input from internal circuits. Disconnect external AC input before servicing unit.</p> </div>
2	UPDATE Switch	Momentary switch that enables the bootloader when it is depressed while the unit is being powered on with the AC input.
LED Mode Indicators		Indicates the mode that is active:
3	POWER	AC input power is turned on to the unit.
4	OUTPUT	Output is turned on.
5	HI RNG	The output voltage is set to a high range.
6	FAULT	Fault condition has occurred; output is shutdown, isolation relay is open, and output voltage is programmed to zero.
7	CC	At least one of the output phases of the power source is presently in Constant-Current mode, and the output current of that output is regulated.
8	CV	All output phases of the power source are presently in Constant-Voltage mode, and the output voltage is regulated.
9	REM/LAN	<p>Source is presently controlled by the remote digital interface. If the RS-232C, USB or LAN interface is used, the REM state can be enabled by the external controller using the SCPI command, SYST:REM. If the optional IEEE-488 (GPIB) interface is used, this indicator will be lit whenever the REM line (REM ENABLE) line is asserted by the IEEE-488 controller.</p> <p>Any time the REM/LAN LED is lit, the front control of the unit is disabled. To regain control through the front panel, the external controller must send the SCPI command, SYST:LOC.</p> <p>With LAN interface, the REM/LAN indicator also provides LXI status.</p>

Table 4-2. Front Panel Controls and Indicators, ATE 2U Models.

4.2 Basic Output Programming

For basic operation, the power source requires selection of the output phase number (1-Phase or 3-Phase), output phase angle, output voltage mode (AC, DC, or AC+DC), voltage range (Low-Range or High-Range), the mode of operation (CV/CC or CV/CL modes), and adjustment of the output parameters (voltage, current, frequency, phase, and DC offset). This could be accomplished through the front panel display by navigating to the appropriate menu, entering the desired values, and enabling the output. Alternately, the remote digital interface could be used with SCPI commands or the Asterion Virtual Panels. Refer to the Asterion Series Programming Manual P/N M330100-01 (distributed on the CD, C1C496), or refer to the AMETEK Programmable Power website, www.programmablepower.com, to download latest version.

4.2.1 Front Panel Display Navigation

The selection of the output characteristics and adjusting the output parameters through the front panel display could be accomplished using the DASHBOARD screen (refer to Figure 4-13) or the OUTPUT PROGRAM screen (refer to Figure 4-16). The selection and adjustment of items could be done using either the touchscreen or rotary encoder:

1. Using the touch-screen or rotary encoder, navigate (refer to Section 4.4.2 and Section 4.4.3) to the HOME Screen, and select the OUTPUT PROGRAM screen (refer to Figure 4-16).
2. Within the OUTPUT PROGRAM screen, select the parameter, and adjust its value.
3. The DASHBOARD screen provides an alternate means of adjusting the primary parameters, voltage, current, and frequency, in the same menu. It is also located in HOME Screen. It has the additional functionality of real-time adjustment of the parameters as the encoder is rotated (refer to Section 4.5.1.1).

4.2.2 Selecting Output Characteristics and Adjusting Parameters

To set up the power source for basic operation with either a sine wave or DC output, perform the following sequence:

1. Navigate to the PHASE NUMBER menu in the OUTPUT PROGRAM screen and select the output phase number: either One-Phase or Three-Phase.
2. Navigate to the PHASE menu in the OUTPUT PROGRAM screen, and select the output phase angle: Phase-B and Phase-C relative to Phase-A.
3. Navigate to the Voltage Mode menu in the OUTPUT PROGRAM screen, and select the output voltage mode: either AC, DC, or AC+DC.
4. Navigate to the VOLTAGE RANGE menu on the OUTPUT PROGRAM screen and select the output range: either Low-Range or High-Range.
5. Navigate to the REGULATION menu in the OUTPUT PROGRAM screen, and select the output voltage/current regulation: either CV/CC or CV/CL.
6. Navigate to the VOLTAGE menu in the OUTPUT PROGRAM screen and adjust the output voltage value.
7. If the AC+DC voltage mode had been selected, navigate to the DC OFFSET menu in the OUTPUT PROGRAM screen, and adjust the DC component of the output voltage.
8. Navigate to the CURRENT menu in the OUTPUT PROGRAM screen and adjust the output current value.

9. Navigate to the FREQUENCY menu in the OUTPUT PROGRAM screen and adjust the output frequency value.
10. The output could be turned on with the front panel OUTPUT switch.

4.3 Basic Functional Test

**WARNING!**

When performing the functional tests, exercise appropriate care to protect against hazardous voltages that are present on the input and output.

Basic functional test of the power source could be performed with the following steps:

1. Connect an oscilloscope and DVM to the power source AC/DC Output connector. Recommended equipment: oscilloscope, Tektronix TDS 3034C with P5202A high-voltage differential probe; DVM, Keysight 34461A.
2. With the AC mains verified as being off, make the AC input voltage connections to the power source input connector.
3. Turn on the AC mains and then turn on the POWER switch on the power source front panel.
4. Verify that the front panel LCD display lights up, or, in the ATE models, the POWER LED. After several seconds the display should show the DASHBOARD Screen Top-Level Menu or the Default screen; refer to Section 4.5 for description of menus.
5. Switch on the resistive load for each phase that is set to draw 90% of full-scale current at 200 V(RMS) for the low-range AC output.
6. Using the front panel display or remote digital interface, set the output of each phase for AC mode operation with the following parameters: voltage mode = AC; voltage range = low, 200 V; output voltage = 200 V(RMS); frequency = 60 Hz; and current setting = full-scale for the particular model being tested. Ensure that the Constant-Voltage/Current-Limit mode is selected in the REGULATION menu of the OUTPUT PROGRAM Screen Top-Level Menu; refer to Section 4.5 for description of menus.
7. Enable the output by tapping the OUTPUT switch. The OUTPUT LED in the switch button will turn on when the output is on.
8. Verify that the output voltage of each phase remains a sine wave within specifications for voltage accuracy.
9. Program the output current to 50% of full-scale output current and verify that a fault condition is generated with the output turned off, the output voltage setting at zero, and the front panel FAULT indicator on.
10. Return the current setpoint to 100% of full-scale and set the output voltage = 200 V(RMS).
11. Enable the output with the OUTPUT switch. The OUTPUT LED in the switch button will turn on when the output is on.
12. Verify that the output voltage of each phase returns to its setpoint.
13. Program the power source to the Constant-Voltage/Constant-Current mode through the display using the REGULATION menu of the OUTPUT PROGRAM Screen Top-Level Menu; refer to Section 4.5 for description of menus.
14. Program the output current to 50% of full-scale output current and verify that the output voltage of each phase is reduced from the setpoint, while the output current is regulated to its setpoint.

15. Return the current setpoint to 100% of full-scale and verify that the output voltage of each phase returns to its setpoint.
16. Turn off the OUTPUT switch.
17. Switch on the resistive load to each phase that is set to draw 90% of full-scale current at 400 V(RMS) for the high-range AC output.
18. Repeat Steps 7 through 11 but set the AC output of each phase for the following:
voltage range = high, 400 V; output voltage = 400 V(RMS); current setting = full-scale for particular model being tested.
19. Repeat Steps 5 through 18 but set the output of each phase for DC mode operation with the voltage set for 250 VDC in the low-range and 500 VDC in the high range, and the load for each phase set appropriately for the DC range selected.

4.4 Output Power Characteristic

The iX2™ Constant-Power output characteristic of the Asterion power source has a power limit that is present in each of the two output voltage ranges (low-range and high-range) for AC and DC outputs. Full rated output power is available from 100% of full-scale output voltage down to 50% of full-scale output voltage; refer to Figure 4-3 for the relation between the voltage and current follows a constant-power curve with the limit being the rated power of the unit: The output current increases to 200% of full-scale output current as output voltage is reduced to 50% of full-scale output voltage. Accordingly, the power source will automatically adjust the allowed maximum value of the programmed output current when the output voltage is within 50% and 100% of full-scale to ensure that the power limit is not exceeded. Refer to graphs for current rating as a function of output voltage and frequency in Figure 2-1 and Figure 2-2.

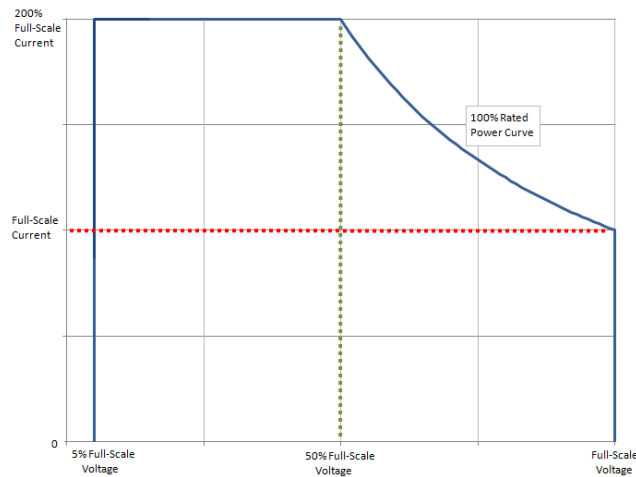

Figure 4-3. iX2™ Constant-Power Output Characteristic

4.4.1 Front Panel Touch-Screen Display

The front panel display of the Asterion Series power source allows the user to select the various menus required to configure and operate the unit. Navigating through the various menus could be done using the touch-screen display or the rotary encoder. Tapping the display screen or clicking with the encoder on any menu or function that is highlighted (active) will enter that menu or execute that function.

The touchscreen utilizes resistive, pressure-actuated technology, and depends on pressure being applied to the top surface of the screen to detect the position of input. A fingertip, fingernail, or stylus pen could be used. To prevent scratching the surface layer, do not use a hard or sharp tip, such as ball-point pen or mechanical pencil.



CAUTION!

Damage or scratching of the touchscreen could occur if excessive pressure is applied to the surface, or if objects with hard/sharp tips are used.

The present cursor position is always shown with a selection-box that has a highlighted border around a field. Some screens have multiple pages, as indicated by the highlighted Arrow icons located on the right side of the screen: for example, the default HOME Screen can be scrolled through three pages. Tapping an Arrow or selecting it with the rotary encoder and clicking the switch, scrolls the screen to the next page. When outside one of the HOME screens, the home icon will exit that screen and return back to the HOME screens. Refer to Figure 4-4.

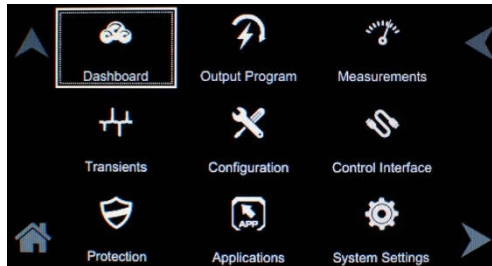

Figure 4-4. HOME Screen

Parameters that are adjustable have selection-fields where values could be entered. The parameter selection-field that is active has its border highlighted; refer to Figure 4-5 where the Dashboard Menu is shown with the voltage selection-field active. Tapping the selection-field box, selects that parameter for adjustment, and the screen changes to the numeric keypad that allows value entry; refer to Figure 4-7.

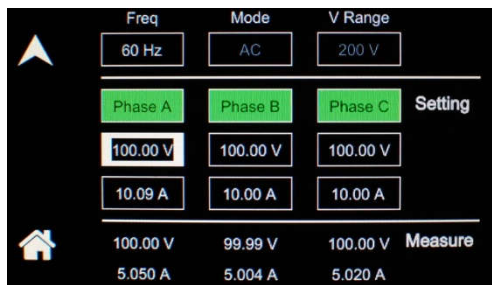

Figure 4-5. DASHBOARD Screen Menu with Voltage Selection-Field Active

When the power source is configured for 3-Phase output, each phase has individual settings. Clicking on a phase button toggles selection of that phase for inputting values. When a phase is selected, its button is displayed with a green color. When a phase is not selected, its button is displayed with a gray color. When the unit is configured for 1-Phase output, only Phase-A is displayed green. When all phases are selected, entry for one phase will make the same changes for the other phases. Refer Figure 4-6 to where only Phase-A has been selected.

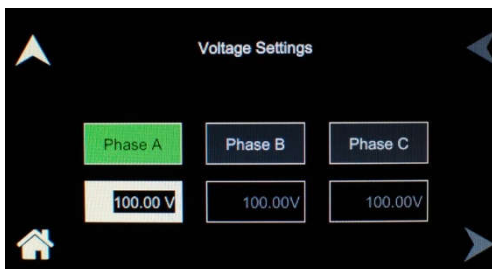

Figure 4-6. Menu with Only Phase-A Selected

4.4.2 Touch-Screen Numeric Keypad

The touch-screen has a keypad that allows numeric value entry; refer to Figure 4-7. After scrolling through menus until a parameter selection-field box is highlighted (active), tapping the selection-field selects it. Afterwards, the keypad screen will be displayed. Tapping numerical value keys, the decimal point key, or the polarity key, selects them, while the back-arrow key erases the last entry. To enter a negative value, first enter the number then the minus sign. The selected values appear in the upper-left parameter window, and the cursor moves to the next available position. Tapping the OK key enters the value to have it take effect.

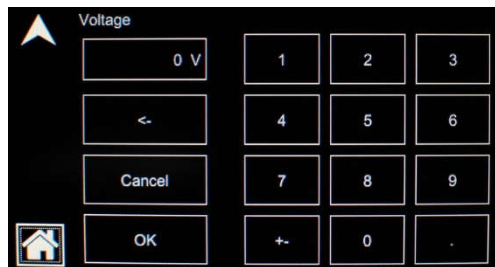

Figure 4-7. Touch-Screen Numeric Keypad

4.4.3 Rotary Encoder

The rotary encoder provides a secondary way to navigate the display. It is used to select functions, change parameter values, and perform setup. It can be used to move between menu screens and between editable items within an individual menu screen.

The rotary encoder is located on the front panel and provides continuous adjustment in the clockwise and counterclockwise rotation; refer to Figure 4-8. Turning the encoder knob allows sequential scrolling through each menu or function on a screen; the item that is active has its selection field-box highlighted. To select a choice, depress the encoder knob to engage the encoder momentary switch.



Figure 4-8. Rotary Encoder

The rotary encoder can operate in one of two distinct modes:

MODE	DESCRIPTION
NAVIGATE	The rotary encoder can be used to scroll through menu screen functions and settings. The current (active) selected item will be outlined in a highlighted selection-field box. As the encoder is rotated, the highlighted box will be scrolled through all items on a screen that could be selected; refer to Figure 4-9.
ADJUST/SELECT	After scrolling to a function, the rotary encoder knob is depressed to select the function (clicking on an item). Clicking on a selection-button will change its state (on or off) and clicking on a function or menu will select it and change to a screen that allows further value entry.

Parameter values, such as voltage and current, are adjusted by selecting the parameter (clicking on it) to enable the selection-field (refer to Figure 4-9). If a parameter had been selected whose value could be adjusted, and the encoder switch is depressed, a screen will be displayed with a parameter selection highlighted that has a value entry window (refer to Figure 4-10). The rotary encoder could then be used to continuously adjust the parameter value, up and down, as the encoder is rotated. Click the encoder a second time to enter the value. If the OUTPUT switch is on, the output parameter will change when the encoder is clicked.

The DASHBOARD screen menu has the capability for real-time adjustment of output parameters: the value of the parameters change as the rotary encoder is turned for immediate effect at the output. If the OUTPUT switch is on, the output parameter will change as the encoder is rotated. Refer to the DASHBOARD screen menu in Section 4.5.1 for a description of the parameters that have real-time adjustability.

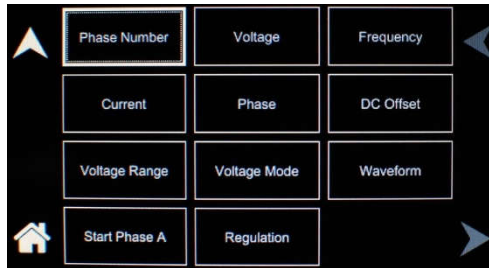
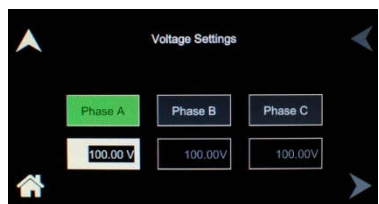
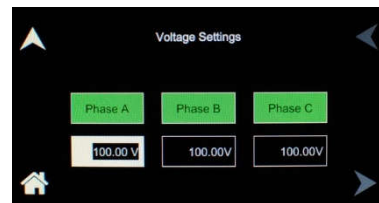

Figure 4-9. Output Program Menu Selection-Fields with Phase Number Highlighted



3-Phase with only Phase-A selected



3-Phase with Phase-A/B/C selected

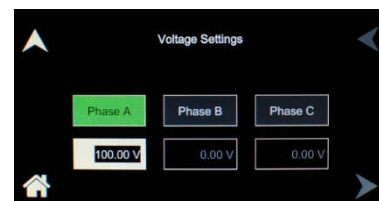

3-Phase unit in 1-Phase mode, or 1-Phase unit

Figure 4-10. Highlighted Voltage Selection-Field with Value Window

The rotary encoder could also be used with the numeric keypad to enter values. After selecting a parameter using the touch-screen, the numeric keypad will be displayed; refer to Figure 4-7. The rotary encoder could be used to select any of the items of the numeric keypad by scrolling through them and clicking on them with the encoder switch to select them. The active value is identified on the screen with a highlighted field-box, and the entered decimal places are shown in the upper-left window. The cursor moves to the next available position as values are entered. After the desired decimal places are entered sequentially, the OK key is clicked to execute the final value and have it taken effect.

4.5 Front Panel Display Menus

At initial power-on, the display shows the Asterion Splash screen followed by the Start-Up screen with the model number, serial number and firmware revisions, and finally the Default screen showing output voltage and current values. Refer to Figure 4-11.

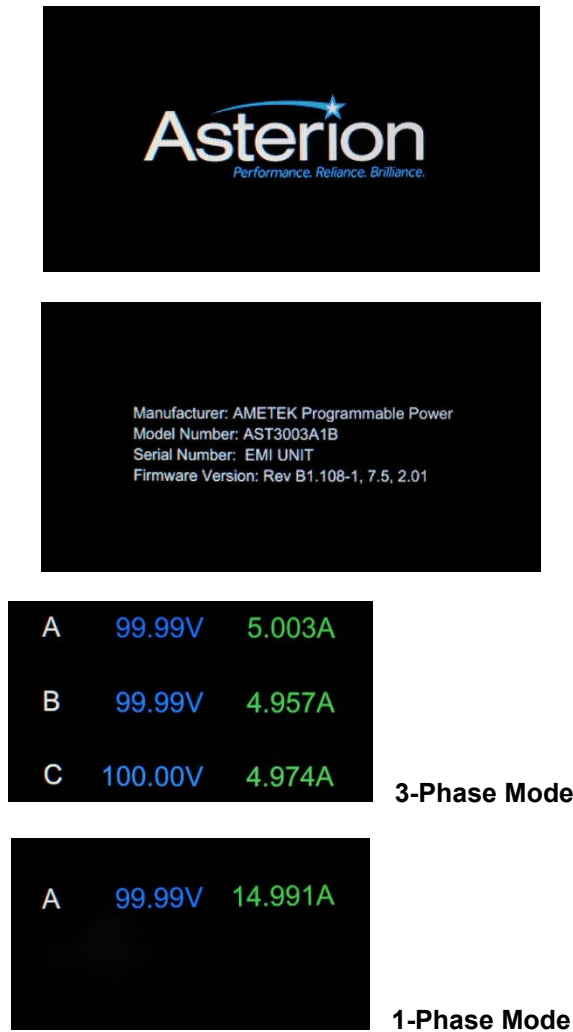

Figure 4-11. Power-On Screens

Selecting the Home icon or Up arrow will open the HOME screen of the menu structure. It is made up of menus, as follows: DASHBOARD, OUTPUT PROGRAM, MEASUREMENTS, TRANSIENTS, CONFIGURATION, CONTROL INTERFACE, PROTECTION, APPLICATIONS, SYSTEM SETTINGS. Each menu of a screen could be selected by tapping its associated selection-field box through the touch-screen, or by selecting it with the rotary encoder and depressing (clicking) the rotary encoder SELECT switch. Refer to Figure 4-12.

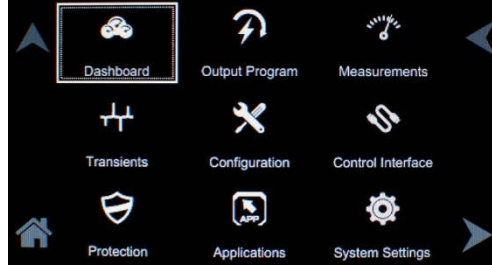

Figure 4-12. HOME Screen

There are four virtual buttons visible on a screen: UP, LEFT, and RIGHT arrows, and HOME icon. Those buttons that are highlighted are active for the particular screen being displayed. The arrow buttons will scroll to the next page of the menu structure in the direction indicated. The HOME button will return to the previous home screen that has the top-level menu from which a sub-menu was entered. The HOME button is no longer functional once a home screen is entered.

The following top-level menu choices can be accessed through the touchscreen:

Top-Level Screen Menu	Menu Description
DASHBOARD	Provides setting and measurement of output parameters: voltage, current, frequency, and voltage range. Provides automatic transition to Default screen.
OUTPUT PROGRAM	Provides setting of phase number, output mode of operation, individual output parameters, mode of regulation, current limit, and output waveform selection
MEASUREMENTS	Provides measurement of output parameters and harmonic distortion, advanced harmonics analysis, no user settings are available.
TRANSIENTS	Provides setup, running, and saving of output transient lists.
CONFIGURATION	Provides setup of power-on states, operation profiles, parameter limits, selection of clock configuration and mode, Default screen, and XLOAD.
CONTROL INTERFACE	Provides setup of remote analog and digital interfaces, and Remote Inhibit.
PROTECTION	Provides setup of OVP protection supervisor.
APPLICATIONS	Provides selection and setup of application-specific options that are installed in the unit.
SYSTEM SETTINGS	Provides display of firmware versions, software options that are installed in the unit; hardware parameter limits, selection of language and brightness for the display, and touch-screen calibration.

Table 4-3. HOME Screen Menu Content

4.5.1 DASHBOARD Screen Top-Level Menu

The DASHBOARD screen top-level menu is used to change output parameters and simultaneously view output measurements. The most commonly used output parameters are located in the DASHBOARD screen menu. The DASHBOARD screen is the default menu that is displayed after power-on.

The top-level menu of the DASHBOARD screen is shown in Figure 4-13. It can be reached in one or two ways:

1. Tapping DASHBOARD on Home Screen of the front panel touchscreen;
2. Scrolling to DASHBOARD with the encoder and depressing the encoder switch.

The UP-arrow button will return back to the previously selected screen menu (in this case the Home Screen-1). The HOME button will return back to the home screen that has the top-level menu for the sub-menu being displayed; for the DASHBOARD screen top-level menu, which is the HOME Screen.



Figure 4-13. DASHBORD Screen Top-Level Menu

The following selections are available on the DASHBOARD screen top-level menu. Functions that accept a numeric value require that the value is within the allowed range, otherwise, an error will be generated, and the value will not be accepted.

When the unit is configured for 3-Phase output, each phase has individual settings. When the unit is configured for 1-Phase output, only Phase-A is displayed. Clicking on a phase button toggles selection of that phase for inputting values. When a phase is selected, its button is displayed with a green color. When a phase is not selected, its button is displayed with a gray color. When all phases are selected, entry for one phase will make the same changes for the other phases.

<u>Entry</u>	<u>Description</u>
<u>Setting</u>	
VOLTAGE	Programs the output voltage in RMS value, V(RMS), when in AC-mode and DC-mode, and the AC component when in (AC+DC)-mode. In (AC+DC)-mode, the DC component is programmed using the DC OFFSET sub-menu in the OUTPUT PROGRAM menu. In DC mode, negative values can also be entered. Real-time setting is possible using the rotary encoder; refer to Section 4.5.1.1.
CURRENT	Programs the output current in RMS value, A(RMS). Real-time setting is possible using the rotary encoder; refer to Section 4.5.1.1.
FREQUENCY	Programs the output frequency in Hz when in AC-mode. If the unit is in DC-mode, the value for FREQ will be set to DC and cannot be changed until AC-mode is selected. When in AC-mode, the frequency can be changed from 16 Hz to 5000 Hz (depending on options). Real-time setting is possible using the rotary encoder; refer to Section 4.5.1.1.
VOLTAGE RANGE	Selects the 200 VAC or 400 VAC range for AC-mode and (AC+DC)-mode, and 250 VDC or 500 VDC range for DC-mode operation. The OUTPUT state must be OFF for a change in range to be executed.
<u>Measure</u>	
VOLTAGE	Displays the true RMS value of the output voltage measured at the voltage sense lines (user selectable to be local or remote). In DC-mode only, the voltage is the DC voltage including polarity.
CURRENT	Displays the true RMS value of the current output. In DC-mode only, the current is the DC current including polarity.
FREQUENCY	When in AC-mode or (AC+DC)-mode, the output frequency is measured at the sense lines. When in DC-mode, this value always reads “DC”.

4.5.1.1 Real-Time Parameter Adjustment

The DASHBOARD screen menu provides the capability for output parameter entry that has real-time, immediate effect on the output. This allows manual adjustment of the output parameters where tuning of a value is desired. Enabling this function requires clicking on a parameter selection-field box with the encoder switch to select the parameter and display its selection-field highlighted and with a value entry window (refer to Figure 4-14). The rotary encoder could then be used to continuously adjust the parameter value, up and down, as it is rotated. The value change has immediate effect on the output.



Figure 4-14. Real-Time, Immediate Output Parameter Adjustment

4.5.1.2 Default Screen

The Default screen provides measurement of the RMS output voltage and current; refer to Figure 4-15. Initially, it appears after power-on if it has been enabled to do so in the configuration setup (user selectable; refer to Section 4.5.5). Subsequently, when in the Dashboard screen, and idle for an interval equal to a set time delay, the display will automatically switch to the Default screen. Tap anywhere on the screen, including the Up arrow, to return to the Dashboard screen; tap the home icon to return to the HOME Screen-1. Refer to Section 4.5.5 for setup of the Default screen.

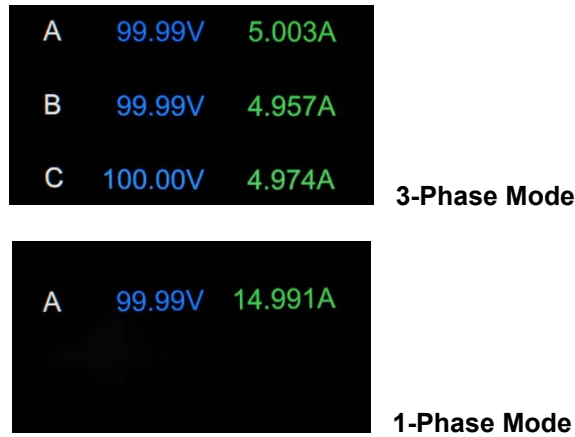

Figure 4-15. Default Screen

4.5.2 OUTPUT PROGRAM Screen Top Level Menus

The OUTPUT PROGRAM screen provides setting of output related items such as individual output parameters, mode of regulation and current limit, output waveform selection, and display of real-time output waveform or harmonics spectrum.

The top-level menus of the OUTPUT PROGRAM screen are shown in Figure 4-16. They could be reached in one or two ways:

1. Tapping the OUTPUT PROGRAM screen on Home Screen of the front panel touchscreen;
2. Scrolling to the OUTPUT PROGRAM screen with the encoder and depressing the encoder switch.

The UP-arrow button will return back to the previously selected screen menu (in this case the HOME Screen). The HOME button will return back to the home screen that has the top-level menu for the sub-menu being displayed; for the OUTPUT PROGRAM screen top-level menu, which is the HOME Screen.

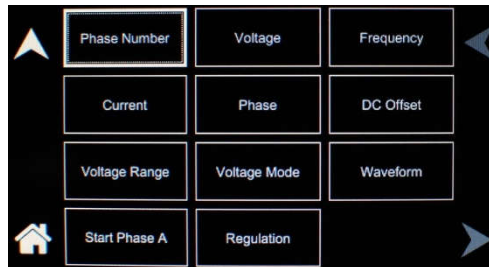

Figure 4-16. OUTPUT PROGRAM Screen Top-Level Menu

The following choices are available in the OUTPUT PROGRAM screen top-level menu. Functions that accept a numeric value require that the value is within the allowed range, otherwise, an error will be generated, and the value will not be accepted.:

Entry	Description
-------	-------------

Settings

PHASE NUMBER

Programs the output phase configuration: One-Phase or Three-Phase. The default is Three-Phase.

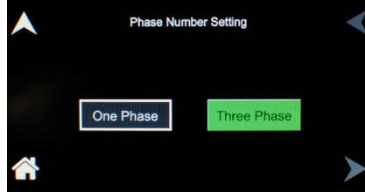

VOLTAGE

Programs the output voltage in RMS value, V(RMS), when in AC-mode and DC-mode, and the AC component when in (AC+DC)-mode. In (AC+DC)-mode, the DC component is set separately using the DC OFFSET selection-field (below), or through the Dashboard screen. In DC-mode, negative values can also be entered. The default is zero.

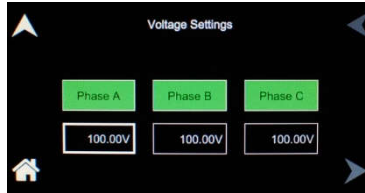

FREQUENCY

Programs the output frequency in Hz when in AC-mode. If the unit is in DC-mode, the value for FREQ will be set to DC and cannot be changed until AC-mode is selected. When in AC-mode, the frequency can be changed from 16 Hz to 5000 Hz (depending on options). The default is 60 Hz.

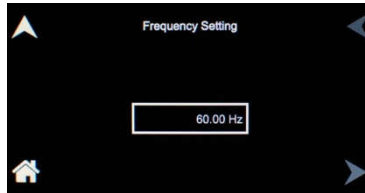

CURRENT

Programs the output current in RMS value, A(RMS). The default is full-scale for the model.



PHASE

Programs the phase angle of the output voltage in a standalone unit operating in 1-Phase configuration; the phase angle would be with respect to the external SYNC signal. In an auxiliary unit (with LKS option) of a multi-phase group, the phase angle would be with respect to Phase-A, while Phase-A would be the reference at 0°. If the clock source is selected to be internal, this parameter has no effect. The default is zero.

In a 3-Phase configuration, programs the Phase-B and Phase-C with respect to the Phase-A reference.

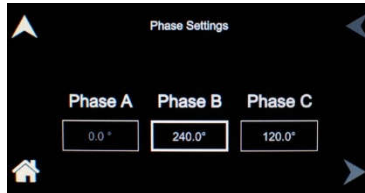

DC OFFSET

Programs the DC offset value, V(DC), when in the (AC+DC)-mode; entries with positive and negative polarity are allowed. The AC component of the output voltage is set separately using the VOLTAGE selection-field (above) or through the Dashboard screen. In AC-mode and DC-mode, this function is not available, and the function is listed as “N/A”. The default is zero.



VOLTAGE RANGE

Selects the 200 VAC or 400 VAC range for AC-mode and (AC+DC)-mode, and 250 VDC or 500 VDC range for DC-mode operation. The output must be turned off for a change in range to be executed. The default is low-range, 200 VAC.

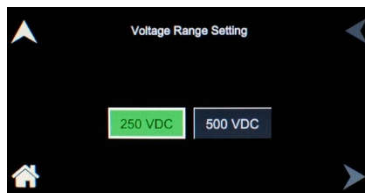
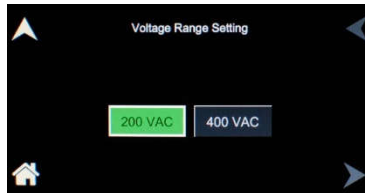

VOLTAGE MODE

Selects the mode of operation of output voltage: either AC only, DC only, or AC with a DC offset, AC+DC. This selection also determines the available output voltage ranges: 200/400 V(RMS) in AC and AC+DC modes, and 250/500 VDC in DC mode. The output must be turned off to change this setting. The default is AC.

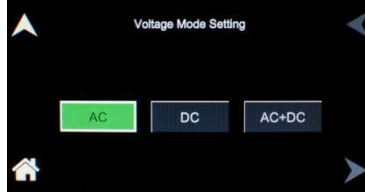

WAVEFORM

Selects the waveform for the output voltage: either standard waveforms for sine wave, square wave, or clipped-sine wave; or user-defined waveforms. The default is sine wave.

The standard waveforms are always available, and do not consume any of the user-defined waveform memory registers; they are always displayed in the waveform list. The clipped-sine waveform has a waveform where the peak amplitude of the positive and negative alternation is clipped (flattened appearance). The level of clipping is dependent on the amount of harmonic distortion present in the output waveform. An additional programmable parameter, CLIP % THD, is available for setting the percentage of total harmonic distortion (THD); the range is 0-43%.

The user-defined waveforms could be selected from up to fifty waveforms in one of four groups (group 0-3, totaling 200 waveforms) that are active. The waveform group that is active at power-on of the unit could be selected with the SCPI command, PONSetup:WGRoup <n>, through the digital interface. For information on generating user-defined waveforms and their selection, refer to the Asterion Virtual Panels or the Asterion Series Programming Manual P/N M330100-01 (distributed on the CD, CIC496), or refer to the AMETEK Programmable Power website, www.programmablepower.com, to download latest versions.

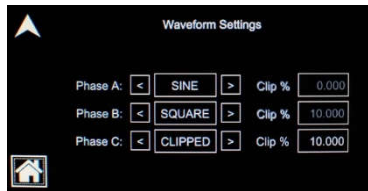

START PHASE A

Programs the phase angle of the output voltage at which Phase-A will begin generating an output. The default is 0°.

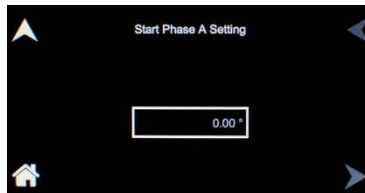

REGULATION

Selects options for regulation of the output voltage: whether ALC is enabled, and what control action will be performed when the load current reaches the current setpoint. The defaults are CV/CL, with Delay of 0.2 seconds and ALC on.

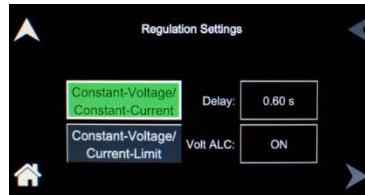

Constant-Voltage/Constant-Current (CV/CC): CV/CC mode will regulate the output voltage to the set value until the load current reaches the current setpoint; after the Delay interval, if the current exceeds the setpoint, the output current will be controlled to equal the setpoint. Regulation of the current load is accomplished by reducing the output voltage as needed to satisfy the load. As such, the voltage could be reduced from the set value down to zero, depending on the load requirement. This mode is useful for starting up motor or capacitor loads that may require a high inrush current.

In constant-voltage mode of operation, the waveform and instantaneous amplitude of the output voltage is regulated to equal the programmed values; if Volt ALC is enabled, the RMS value is also precisely regulated. In constant-current mode of operation, the RMS value of the output current is regulated to equal the programmed value. However, this is accomplished by controlling the voltage amplitude and waveform, and not directly the current; therefore, the current instantaneous amplitude and waveform and dependent on load characteristics.

Constant-Voltage/Current-Limit (CV/CL): CV/CL mode will regulate the output voltage to the set value until the load current reaches the current setpoint; after the Delay interval, if the current equals or exceeds the setpoint, a fault condition will be generated, and the output voltage will be programmed to zero and the isolation relay opened. This effectively turns off the AC source output in case of an overload condition, after the user-programmable trip time-delay.

Delay: Sets the time duration that the output current could equal or exceed the current setpoint before control action is taken. After the delay, if CV/CC mode is selected, the output current will be regulated to its setpoint; if CV/CL mode is selected, an overcurrent fault condition will be generated, and the output will be turned off. The Delay is programmable from 0.1-5 seconds.

Volt ALC: Volt ALC selects whether the automatic loop control, ALC, is enabled. ALC provides improved output regulation and accuracy by regulating the RMS value of the output voltage through action of a digital regulator that measures the output voltage and controls it to equal the setpoint.

ON: ALC is enabled; regulation is accomplished through the RMS digital regulator; if the RMS digital regulator exceeds its control capability and cannot maintain regulation, the output will be shut down, and a fault condition will be generated with the output turned off and the voltage programmed to zero;

REG: ALC is enabled; regulation is accomplished through the RMS digital regulator; if the RMS digital regulator exceeds its control capability and cannot maintain regulation, the output will remain on, but the voltage will deviate from the setpoint, and a fault condition will not be generated;

OFF: ALC disabled; regulation is accomplished without use of the RMS digital regulator, and shutdown that is dependent on loss of regulation will not occur.

4.5.3 MEASUREMENTS Screen Top-Level Menus

The Asterion Series power source uses a DSP-based data acquisition system to provide extensive information regarding the output parameters. This data acquisition system digitizes the voltage and current waveforms and calculates parameter values from the data. The result of these calculations is displayed in a series of measurement data screens. The actual digitized waveforms can also be displayed by selecting the Trace Capture screen. The MEASUREMENTS screen top-level menu is used to display the results of output parameter measurements, harmonics analysis, and output waveforms.

The top-level menus of the MEASUREMENTS screens are shown in Figure 4-17. They can be reached in one or two ways:

1. Tapping MEASUREMENTS on Home Screen of the front panel touchscreen;
2. Scrolling to MEASUREMENTS with the encoder and depressing the encoder switch.

The UP-arrow button will return back to the previously selected screen menu (in this case the Home Screen). The HOME button will return back to the home screen that has the top-level menu for the sub-menu being displayed; for the MEASUREMENTS screen top-level menu, which is the HOME Screen.

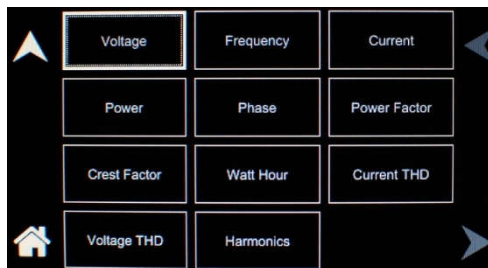
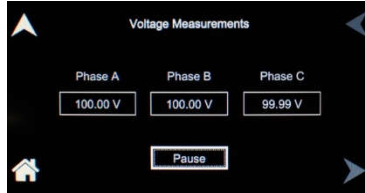

Figure 4-17. MEASUREMENTS Screen Top-Level Menu

The following functions are available on the menu of the MEASUREMENTS screen:

Entry	Description
-------	-------------

VOLTAGE	Displays the true RMS value of the output voltage measured at the voltage sense lines (user selectable to be local or remote). In DC-mode only, the voltage is the DC voltage including polarity.
----------------	---



FREQUENCY	When in AC-mode or (AC+DC)-mode, displays the output frequency. In the DC-mode, this value always reads “DC”.
------------------	---

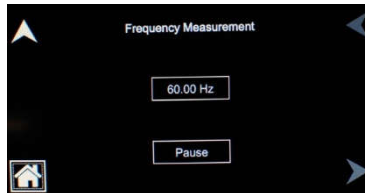

POWER	Displays the true power, kW, and apparent power, kVA, of the load.
--------------	--



CURRENT	When in AC-mode or (AC+DC)-mode, displays the RMS output current. In the DC-mode, the DC current displays including polarity. The Peak Current displayed is the maximum instantaneous value that has been detected. The Reset function allows resetting the peak value to zero and restarting current tracking. The peak current measurement will continuously track the maximum current value detected until reset.
----------------	--

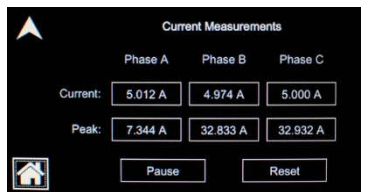

PHASE

Displays the phase angle of the output of the power source: in a standalone unit, the phase angle would be with respect to the external SYNC signal; in an auxiliary unit (with LKS option) of a multi-phase group, the phase angle would be between the Auxiliary output and the Master output. If the clock source is selected to be internal, this parameter is not used.

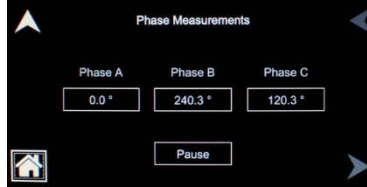

POWER FACTOR

Displays the power factor of the load.

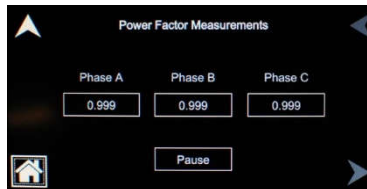

CREST FACTOR

Displays the crest factor of the output current as the ratio of its peak value to its RMS value.

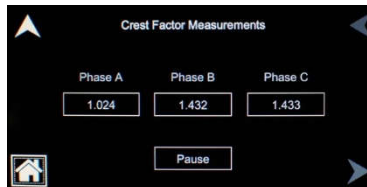

WATT HOUR

Displays the energy, kWh, consumed by the load, and the true power in kW. The Start and Stop function determine the interval during which energy is calculated. The Clear function resets the accumulated energy value.



CURRENT THD

Displays the total distortion of the output current. The distortion calculation is based on the harmonic's currents, H2 through H50, relative to the total RMS value of the current. Another common definition of THD calculates the harmonics relative to the value of the fundamental current H1. There might be a difference in results depending on the harmonic content. The method is selectable over the digital interface with the SCPI command, MEAS:THD:MODE <value>, with the value being either RMS (relative to total RMS) or FUND (relative to fundamental).

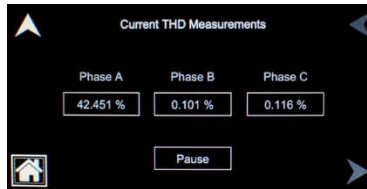

VOLTAGE THD

Displays the total distortion of the output voltage. The distortion calculation is based on the harmonic's voltages, H2 through H50, relative to the total RMS value of the voltage. Another common definition of THD calculates the harmonics relative to the value of the fundamental voltage H1. There might be a difference in results depending on the harmonic content. The method is selectable over the digital interface with the SCPI command, MEAS:THD:MODE <value>, with the value being either RMS (relative to total RMS) or FUND (relative to fundamental).

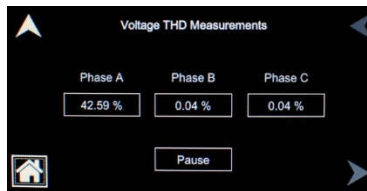

HARMONICS

Displays harmonic content of voltage and current waveforms derived from an FFT analysis. The amplitude and phase of harmonics up to the 50th (bandwidth limited) are calculated and displayed.

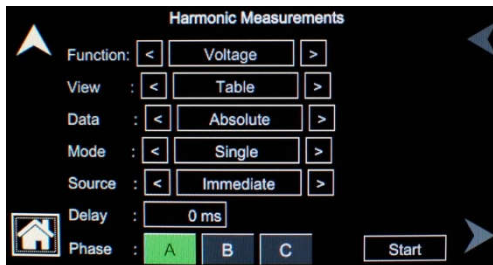

Figure 4-18. HARMONICS Menu

The HARMONICS menu has the following fields:

Entry	Description
FUNCTION	<u>HARMONICS menu:</u> Selects Voltage or Current for display.
VIEW	<p><u>HARMONICS menu:</u> Selects display modes, as follows:</p> <p>Table: Displays the first 50 harmonics (bandwidth limited) in a tabular text format, shown below;</p> <p>Bar: Displays the first 50 harmonics (bandwidth limited) in a graphical bar chart display, shown below.</p>
DATA	<u>HARMONICS menu:</u> Selects absolute or relative harmonics display for TABLE and BAR view modes. In relative mode, all harmonics are shown in a percentage of the fundamental which is normalized at 100%. In absolute mode, the harmonic amplitudes are shown in absolute volts or amperes.
MODE	<p><u>HARMONICS menu:</u> Selects the trigger mode for the acquisition, as follows:</p> <p>SINGLE: Single-shot acquisition; in this mode, the acquisition is triggered once each time the START field is selected. The selected trigger source is used to determine the trigger point. Once the acquisition has been triggered, the data is displayed and does not change until the next acquisition is triggered. This mode is most appropriate for single-shot events, such as startup currents.</p> <p>CONTINUE: Continuous acquisition; in this mode, acquisitions occur repeatedly and the data is updated on screen after each trigger occurrence. This provides a continuous update of the data and is most appropriate for repetitive signals.</p>
SOURCE	<p><u>HARMONICS menu:</u> Selects the event that will trigger a measurement acquisition, as follows;</p> <p>IMMEDIATE: Causes the acquisition to trigger immediately when the START field is selected. This is an asynchronous trigger event. The acquisition will always be triggered in this mode and data is available immediately.</p> <p>PHASE: Causes the acquisition to trigger on the occurrence of zero phase angle of the output voltage. When started, the acquisition starts until the zero-phase angle occurs, before triggering the acquisition. This mode allows exact positioning of the acquisition data window with respect to the voltage waveform.</p>
DELAY	<u>HARMONICS menu:</u> Selects the time delay to position the trigger point relative to the acquisition window. A negative value will provide pre-trigger information on data leading up to the trigger event. The pre-trigger delay cannot exceed the length of the acquisition buffer; see Section 6.3.3 for details. A positive trigger delay positions the data window after the trigger event. Positive trigger delays can exceed the length of the acquisition buffer in which case the trigger itself will not be in the buffer anymore. The maximum value of the trigger delay is 1000 ms. The default trigger delay value is 0.0 ms which puts the trigger event at the beginning of the acquisition window.

4.5.4 TRANSIENTS Screen Top-Level Menu

The Asterion Series power source provides the capability of generating custom waveforms through programming the output in a sequence of steps in a list of transients. The steps could be comprised of combinations of changes in voltage, frequency, phase angle, waveform, and duration. The list could be created, run and stored through either the front panel, or the remote digital interface using the Asterion Virtual Panels program or SCPI commands. A library of lists could be produced and stored in memory of the power source for quick recall and utilization through use of SCPI commands or the Asterion Virtual Panels. Refer to the Asterion Series Programming Manual P/N M330100-01 (distributed on the CD, CIC496), or refer to the AMETEK Programmable Power website, www.programmablepower.com, to download latest version.

The TRANSIENTS Screen provides access to the transient list data. A transient list of up to 100 data points is possible, represented by 100 transient step numbers from 0 through 99.

The top-level menu of the TRANSIENTS screen is shown in Figure 4-21. It can be reached in one or two ways:

1. Tapping TRANSIENTS on Home Screen of the front panel touchscreen;
2. Scrolling to TRANSIENTS with the encoder and depressing the encoder switch.

The UP-arrow button will return back to the previously selected screen menu (in this case the Home Screen). The HOME button will return back to the home screen that has the top-level menu for the sub-menu being displayed; that is HOME Screen for the TRANSIENTS screen top-level menu.

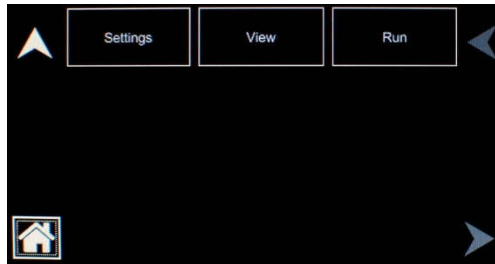

Figure 4-21. TRANSIENTS Screen Top-Level Menu

The following menus are available on the top-level TRANSIENTS menu: SETTINGS, VIEW, RUN.SETTINGS Menu

The SETTINGS menu allows selection of how parameter values are entered for time, voltage, and frequency, trigger sources and characteristics, and how a list is executed; refer to Figure 4-22.

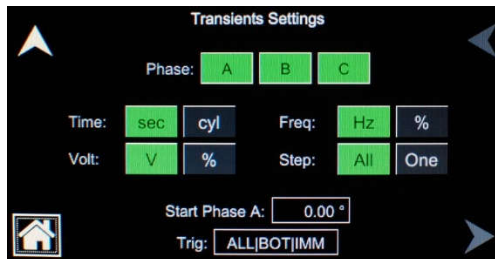

Figure 4-22. SETTINGS Menu

The SETTINGS menu has the following fields:

Entry	Description
Phase	Sets the output phase to which the programming of the transients will be applied.
Time	Sets the units for time of the transient step; the default units are in seconds. Alternatively, the time could be changed to cycles of the output frequency. Note that time durations in seconds may result in rounding errors if the period of the programmed frequency is not an integer number of milliseconds. For example, for 50 Hz output (20 ms period), no rounding errors occur, but for 60Hz (16.66 ms period) a rounding error would occur when converted. The time duration scale selection affects both the Time and End Delay parameters.
Volt(age)	Sets the units for voltage values; the default units are in V(RMS). V is the RMS value of the output voltage, while % is the percentage of the steady-state setting.
Freq(ueency)	Sets the units for frequency values; the default units are in Hz. Hz is the value of the output frequency, while % is the percentage of the steady-state setting.
Start Phase A	Shows the start phase angle of the voltage transient in degrees. Only one start phase angle per transient sequence is allowed. The start phase angle must be in the first transient event of the list. The start phase angle is not valid for DC transients.
Step	Defines how the step sequence of the transient list is executed; the default is All: All: All of the steps in the sequence are executed without breaks; Single: Each step is executed one at a time.
Trig(ger)	The present state of the trigger settings is shown in the TRIG field. Tap on the field to open the TRIGGER sub-menu to change settings; refer to Figure 4-23.

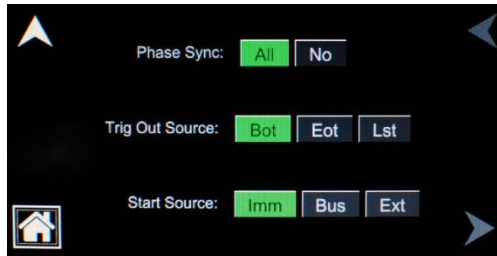

Figure 4-23. SETTINGS Screen, TRIGGER Sub-Menu

The TRIGGER sub-menu has the following fields:

Entry	Description
Phase Sync	<p>TRIGGER sub-menu: Determines when phase synchronization is done; the default phase sync is All:</p> <p>All: Synchronization is done at the beginning of the transient list or pulse, for every count;</p> <p>No(ne): Synchronization is done once at the beginning of the transient list only for the first count.</p>
Trig Outsource	<p>TRIGGER sub-menu: Selects the source for the trigger output; the default source is BOT:</p> <p>Bot: Beginning of transient output;</p> <p>Eot: End of transient output;</p> <p>List: At each point in the list (that has list-trigger enabled) when that step is reached.</p>
Start Source	<p>TRIGGER sub-menu: Determines the source of the trigger event for the transient; the default source is IMM(ediate):</p> <p>Imm(ediate): Triggering occurs as soon as the SCPI command, INITiate, is received;</p> <p>Bus: Triggering occurs following the SCPI command, INITiate, after receiving the SCPI command, *TRG, or the IEEE-488 Group Execute Trigger (GET) signal from the GPIB interface;</p> <p>Ext(ernal): Triggering occurs when an external trigger input is received.</p>

4.5.4.1 VIEW Menu

The VIEW menu shows the transient list, with sequence numbers which are stored in the transient list buffer. Figure 4-24 shows the menu when the buffer is empty, while Figure 4-25 shows the menu when entries are present.

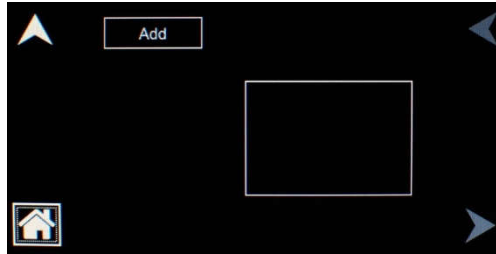

Figure 4-24. VIEW Menu, With Empty Buffer

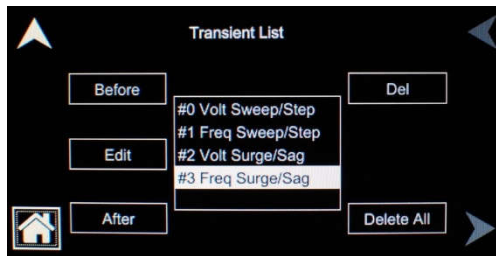

Figure 4-25. VIEW Menu, With Transient List Entry

The VIEW menu has the following fields:

Entry	Description
Add	Allows generating a new transient list.
Before	Inserts a step before the selected transient step
Edit	Opens the selected step for editing parameters.
After	Inserts a step after the selected transient step
Del	Permanently deletes the selected transient step.
Delete All	Clears the transient list buffer

4.5.4.2 ADD Sub-Menu

The ADD sub-menu is opened when the ADD function is selected on the VIEW screen; refer to Figure 4-26. It allows selection of the type of transient to be added to the sequence.

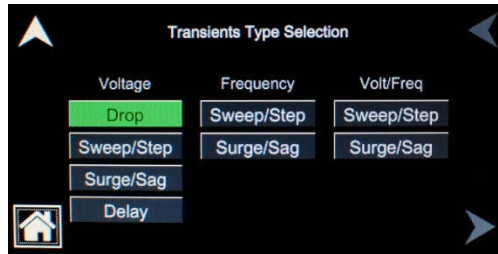
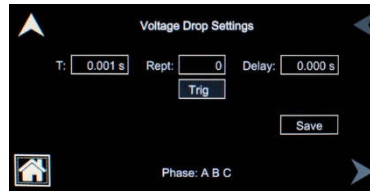

Figure 4-26. VIEW Menu, ADD Sub-Menu

The ADD sub-menu has the following fields:

Entry	Description
DROP	Causes the output voltage to go to zero volts for a specified period of time. As with the step transient, the voltage change is instantaneous. At the end of the drop, the voltage will return to the amplitude at the beginning of the step.



VOLTAGE SWEEP/STEP	VOLTAGE SWEEP causes the output voltage to change from the present value to a specified end value at a specified rate of change, while a VOLTAGE STEP causes an instantaneous change in output voltage. The new value will be held for the specified time duration. The final output voltage value of a sweeper and a step transient step should be different than the value at the start of the transient step, or no change in output voltage will occur.
---------------------------	---

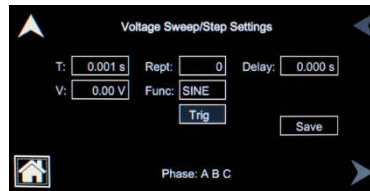

VOLTAGE SURGE/SAG

VOLTAGE SURGE and SAG are temporary changes in amplitude. The output voltage will change from its present value to a specified value for a specified duration. Surge is a change to a higher value, while sag is a change to a lower value. After the time duration has expired, the output voltage returns to a specified end value. This value could be the same or different from the value present prior to the start of the surge or sag.

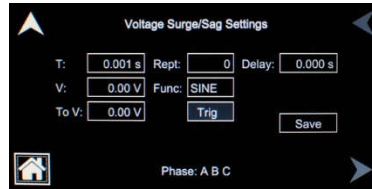

FREQUENCY SWEEP/STEP

FREQUENCY SWEEP causes the output frequency to change from the present value to a specified end value at a specified rate of change, while a FREQUENCY STEP is an instantaneous change in output frequency. The new value will be held for the specified time duration. The final output frequency value of a sweep and a step transient step should be different than the value at the start of the transient step, or no change in output frequency will occur.

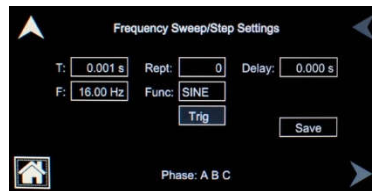

FREQUENCY SURGE/SAG

FREQUENCY SURGE and SAG are temporary changes in frequency. The output frequency will change from its present value to a specified value for a specified duration. Surge is a change to a higher value, while sag is a change to a lower value. After the time duration has expired, the output frequency returns to a specified end value. This value could be the same or different from the value present prior to the start of the surge or sag.

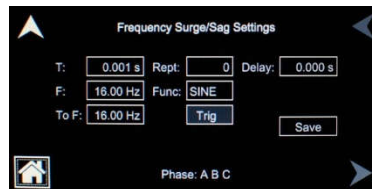

VOLT/FREQ SWEEP/STEP This transient type combines voltage and frequency changes into a single step. The effect is that of changing the output voltage and frequency simultaneously. While this transient is programmed as a single transient step, two list entries are required to store this information. As such, every VOLT/FREQ SWEEP/STEP combined step will consume two list entries at a time.

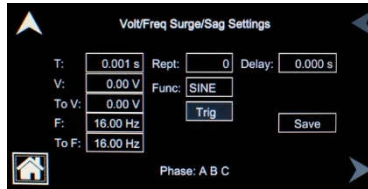

VOLT/FREQ SURGE/SAG This transient type combines voltage and frequency changes into a single step. The effect is that of changing the output voltage and frequency simultaneously. While this transient is programmed as a single transient step, two list entries are required to store this information. As such, every VOLT/FREQ SWEEP/STEP combined step will consume two list entries at a time.

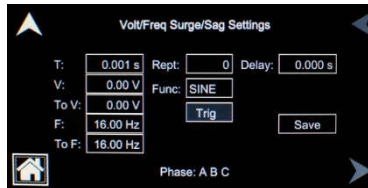

DELAY

Sets the time duration, in seconds or cycles that the voltage amplitude and frequency will stay at their existing levels, before the next transient event is executed or the transient list is complete.

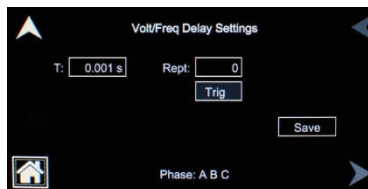

4.5.4.3 VOLTAGE DROP Sub-Menu

The VOLTAGE DROP menu allows programming the output voltage to zero at the maximum slew rate. After the drop time duration, the voltage returns to the previous level. Refer to Figure 4-27. When the transient definition is complete, tap SAVE to store the transient step settings in non-volatile memory and return to the ADD menu.

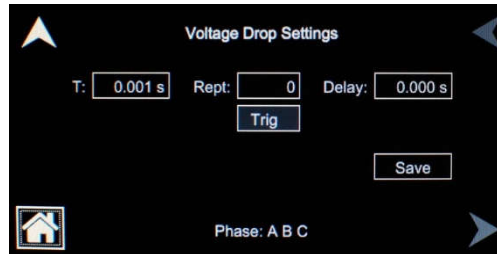

Figure 4-27. VIEW Menu, VOLTAGE DROP Sub-Menu

The VOLTAGE DROP sub-menu has the following fields:

Entry	Description
T(ime)	Sets the time, in seconds or cycles that the output voltage will dwell at zero.
Rep(eat)	Sets the number of times the sweep/step transient event will be repeated before execution will proceed to the next event or exit the transient list. The number of times the transient event is generated is equal to the value, REPEAT+1. The value should be zero if only one execution of this event in the list is desired.
Trig(ger)	Causes a trigger pulse to be generated for the selected event when LIST is selected for Trig(ger) Outsource in the SETTINGS menu.
Delay	Sets the time duration, in seconds or cycles, that the voltage amplitude will stay at the previous level (before the drop to zero), before the next transient event is executed, or the transient list is completed.
Save	Completes the transient editing. All data fields should be entered before saving. The event number is automatically set based on the selection of either BEFORE or AFTER in the VIEW menu and will be a value between 0 and 99. The event number determines the order of execution of the transient events in a multiple event transient.
Phase	Displays the phases that had been selected in the Settings menu.

4.5.4.4 VOLTAGE SWEEP/STEP Sub-Menu

The VOLTAGE SWEEP/STEP menu allows changing the voltage amplitude during a transient. A voltage sweep is a continual change in amplitude that takes place over a period of time, while during a voltage step, the change occurs at the maximum slew-rate. Refer to Figure 4-28. When the transient definition is complete, tap SAVE to store the transient step settings in non-volatile memory and return to the ADD menu.

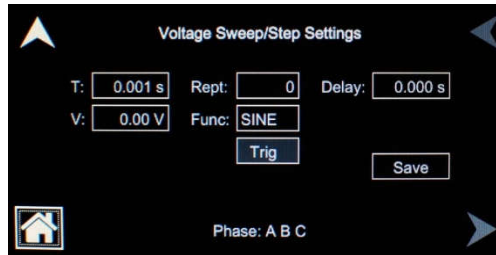

Figure 4-28. VIEW Menu, VOLTAGE SWEEP/STEP Sub-Menu

The VOLTAGE SWEEP/STEP sub-menu has the following fields:

Entry	Description
T(ime)	Sets the time, in seconds or cycles, that it will take for the output voltage to reach the level set in the V(olts) field (end voltage). As such, the T(ime) value will define the slew rate of the output voltage for the event. Duration of 0.001 seconds will cause the output voltage to reach the end voltage at the maximum slew rate.
V(olts)	Sets the voltage amplitude, in volts, that will be reached after the sweep or step.
Rep(eat)	Sets the number of times the sweep/step transient event will be repeated before execution will proceed to the next event or exit the transient list. The number of times the transient event is generated is equal to the value, REPEAT+1. The value should be zero if only one execution of this event in the list is desired.
Func(tion)	Selects the waveform to be used during this section of the transient sequence. Each section could use a different waveform from the available of user-defined waveforms or from the three standard waveforms. The output waveform changes upon entry into each section and remains in effect for the duration of the section. The default waveform is always the SINE (sine wave).
Trig(ger)	Causes a trigger pulse to be generated for the selected event when LIST is selected for Trig(ger) Outsource in the SETTINGS menu.
Delay	Sets the time duration, in seconds or cycles that the voltage amplitude will stay at the level, V(olts), before the next transient event is executed, or the transient list is completed.
Save	Completes the transient editing. All data fields should be entered before saving. The event number is automatically set based on the selection of either BEFORE or AFTER in the VIEW menu and will be a value between 0 and 99. The event number determines the order of execution of the transient events in a multiple event transient.
Phase	Displays the phases that had been selected in the Settings menu.

4.5.4.5 VOLTAGE SURGE/SAG Sub-Menu

The VOLTAGE SURGE/SAG menu allows temporarily changing the voltage amplitude during a transient. The output voltage will change from its present value to a specified value for a specified duration. After this duration has expired, the output voltage returns to a specified end value. Refer to Figure 4-29. When the transient definition is complete, tap SAVE to store the transient step settings in non-volatile memory and return to the ADD menu.

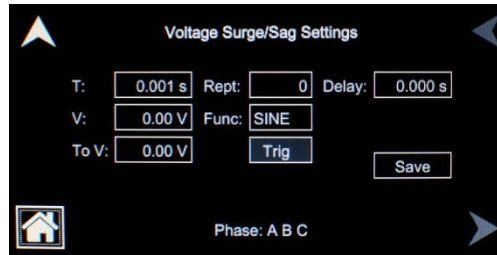

Figure 4-29. VIEW Menu, VOLTAGE SURGE/SAG Sub-Menu

The VOLTAGE SURGE/SAG sub-menu has the following fields:

Entry	Description
T(ime)	Sets the time, in seconds or cycles that the output voltage will dwell at the level set in the V(olts) field.
V(olts)	Sets the voltage amplitude, in volts, that will be reached during the surge or sag time duration.
To V(olts)	Sets the output voltage level, in volts, at the end of the transient surge/sag event and after a time specified by T(ime).
Rep(eat)	Sets the number of times the surge/sag transient event will be repeated before execution will proceed to the next event or exit the transient list. The number of times the transient event is generated is equal to the value, REPEAT+1. The value should be zero if only one execution of this event in the list is desired.
Func(tion)	Selects the waveform to be used during this section of the transient sequence. Each section could use a different waveform from the available library of user-defined waveforms or from the three standard waveforms. The output waveform changes upon entry into each section and remains in effect for the duration of the section. The default waveform is always the SINE (sinewave).
Trig(ger)	Causes a trigger pulse to be generated for the selected event when LIST is selected for Trig(ger) Outsource in the SETTINGS menu.
Delay	Sets the time duration, in seconds or cycles, that the voltage amplitude will stay at the level, To V(olts), before the next transient event is executed, or the transient list is completed.
Save	Completes the transient editing. All data fields should be entered before saving. The event number is automatically set based on the selection of either BEFORE or AFTER in the VIEW menu and will be a value between 0 and 99. The event number determines the order of execution of the transient events in a multiple event transient.
Phase	Displays the phases that had been selected in the Settings menu.

4.5.4.6 FREQUENCY SWEEP/STEP Sub-Menu

The FREQUENCY SWEEP/STEP menu allows changing the frequency during a transient. A frequency sweep is a continual change in amplitude that takes place over a period of time, while during a frequency step, the change occurs at the maximum slew-rate. Refer to Figure 4-30. When the transient definition is complete, tap SAVE to store the transient step settings in non-volatile memory and return to the ADD menu.

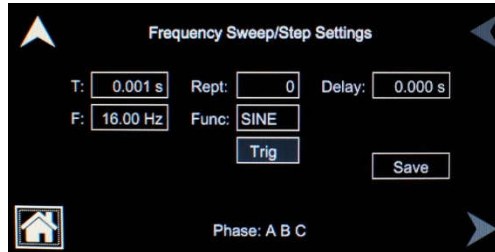

Figure 4-30. VIEW Menu, FREQUENCY SWEEP/STEP Sub-Menu

The FREQUENCY SWEEP/STEP sub-menu has the following fields:

Entry	Description
T(ime)	Sets the time, in seconds or cycles, that it will take for the output frequency to reach the level set in the F(requency) field (end voltage). As such, the T(ime) value will define the slew rate of the output frequency for the event. A duration of 0.001 seconds will cause the output frequency to reach the end frequency at the maximum slew rate.
F(requency)	Sets the frequency value, in hertz, that will be reached after the sweep or step.
Rep(eat)	Sets the number of times the sweep/step transient event will be repeated before execution will proceed to the next event or exit the transient list. The number of times the transient event is generated is equal to the value, REPEAT+1. The value should be zero if only one execution of this event in the list is desired.
Func(tion)	Selects the waveform to be used during this section of the transient sequence. Each section could use a different waveform from the available library of user-defined waveforms or from the three standard waveforms. The output waveform changes upon entry into each section and remains in effect for the duration of the section. The default waveform is always the SINE (sinewave).
Trig(ger)	Causes a trigger pulse to be generated for the selected event when LIST is selected for Trig(ger) Outsource in the SETTINGS menu.
Delay	Sets the time duration, in seconds or cycles, that the frequency will stay at the level, F(requency), before the next transient event is executed, or the transient list is completed.
Save	Completes the transient editing. All data fields should be entered before saving. The event number is automatically set based on the selection of either BEFORE or AFTER in the VIEW menu and will be a value between 0 and 99. The event number determines the order of execution of the transient events in a multiple event transient.
Phase	Displays the phases that had been selected in the Settings menu.

4.5.4.7 FREQUENCY SURGE/SAG Sub-Menu

The FREQUENCY SURGE/SAG menu allows temporarily changing the frequency during a transient. The output frequency will change from its present value to a specified value for a specified duration. After this time duration has expired, the output frequency returns to a specified end value. Refer to Figure 4-31. When the transient definition is complete, tap SAVE to store the transient step settings in non-volatile memory and return to the ADD menu.

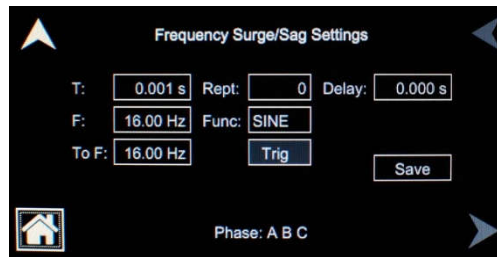

Figure 4-31. VIEW Menu, FREQUENCY SURGE/SAG Sub-Menu

The FREQUENCY SURGE/SAG sub-menu has the following fields:

Entry	Description
T(ime)	Sets the time, in seconds or cycles, that the output frequency will dwell at the level set in the F(requency) field.
F(requency)	Sets the frequency, in hertz, that will be reached during the surge or sag time duration.
To F(requency)	Sets the frequency, in hertz, that will be reached at the end of the transient surge/sag event and after a time specified by T(ime).
Rep(eat)	Sets the number of times the surge/sag transient event will be repeated before execution will proceed to the next event or exit the transient list. The number of times the transient event is generated is equal to the value, REPEAT+1. The value should be zero if only one execution of this event in the list is desired.
Func(tion)	Selects the waveform to be used during this section of the transient sequence. Each section could use a different waveform from the available library of user-defined waveforms or from the three standard waveforms. The output waveform changes upon entry into each section and remains in effect for the duration of the section. The default waveform is always the SINE (sinewave).
Trig(ger)	Causes a trigger pulse to be generated for the selected event when LIST is selected for Trig(ger) Outsource in the SETTINGS menu.
Delay	Sets the time duration, in seconds or cycles, that the frequency will stay at the level, To F(requency), before the next transient event is executed, or the transient list is completed.
Save	Completes the transient editing. All data fields should be entered before saving. The event number is automatically set based on the selection of either BEFORE or AFTER in the VIEW menu and will be a value between 0 and 99. The event number determines the order of execution of the transient events in a multiple event transient.
Phase	Displays the phases that had been selected in the Settings menu.

4.5.4.8 VOLT/FREQ SWEEP/STEP Sub-Menu

The VOLT/FREQ SWEEP/STEP menu allows combining voltage and frequency sweep/step changes into a single transient event. The effect is that of changing the output voltage and frequency simultaneously. While this transient is programmed as a single event, two list entries are required to store this information. Refer to Figure 4-32. When the transient definition is complete, tap SAVE to store the transient step settings in non-volatile memory and return to the ADD menu.

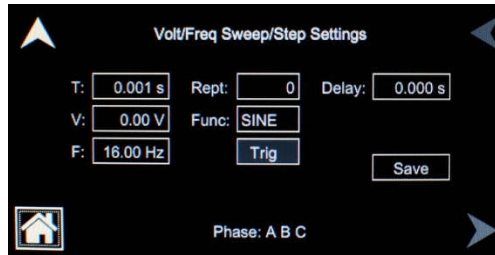

Figure 4-32. VIEW Menu, VOLT/FREQ SWEEP/STEP Sub-Menu

The VOLT/FREQ SWEEP/STEP sub-menu has the following fields:

Entry	Description
T(ime)	Sets the time, in seconds or cycles, that it will take for the output frequency to reach F(requency) and the output voltage to reach V(olts). As such, the T(ime) value will define the slew rate of the output frequency and output voltage for the event. A duration of 0.001 seconds will cause the output voltage to reach the end voltage at the maximum slew rate.
V(olts)	Sets the voltage amplitude, in volts, that will be reached after the sweep or step.
F(requency)	Sets the frequency (Hz) that will be reached after the sweep or step.
Rep(eat)	Sets the number of times the sweep/step transient event will be repeated before execution will proceed to the next event or exit the transient list. The number of times the transient event is generated is equal to the value, REPEAT+1. The value should be zero if only one execution of this event in the list is desired.
Func(tion)	Selects the waveform to be used during this section of the transient sequence. Each section could use a different waveform from the available library of user-defined waveforms or from the three standard waveforms. The output waveform changes upon entry into each section and remains in effect for the duration of the section. The default waveform is always the SINE (sinewave).
Trig(ger)	Causes a trigger pulse to be generated for the selected event when LIST is selected for Trig(ger) Outsource in the SETTINGS menu.
Delay	Sets the time duration, in seconds or cycles, that the voltage amplitude and frequency will stay at the V(olts) and F(requency) levels, before the next transient event is executed, or the transient list is completed.
Save	Completes the transient editing. All data fields should be entered before saving. The event number is automatically set based on the selection of either BEFORE or AFTER in the VIEW menu and will be

a value between 0 and 99. The event number determines the order of execution of the transient events in a multiple event transient.

Phase Displays the phases that had been selected in the Settings menu.

4.5.4.9 VOLT/FREQ SURGE/SAG Sub-Menu

The VOLT/FREQ SURGE/SAG menu allows combining voltage and frequency surge/sag changes into a single transient event. The effect is that of changing the output voltage and frequency simultaneously. While this transient is programmed as a single event, two list entries are required to store this information. Refer to Figure 4-33. When the transient definition is complete, tap SAVE to store the transient step settings in non-volatile memory and return to the ADD menu.

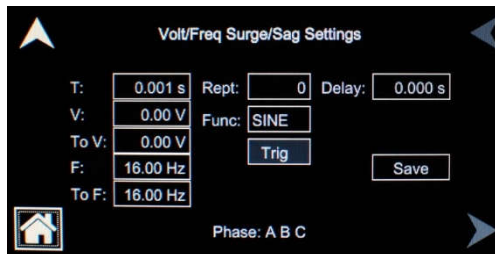

Figure 4-33. VIEW Menu, VOLT/FREQ SURGE/SAG Sub-Menu

The VOLT/FREQ SURGE/SAG sub-menu has the following fields:

Entry	Description
T(ime)	Sets the time, in seconds or cycles, that the output frequency will dwell at F(requency) and the output voltage to dwell at V(olts).
V(olts)	Sets the voltage amplitude, in volts, that will be reached during the surge or sag time duration.
To V(olts)	Sets the output voltage amplitude, in volts, at the end of the transient surge/sag event and after a time specified by T(ime).
F(requency)	Sets the frequency, in hertz, that will be reached during the surge or sag time duration.
To F(requency)	Sets the output frequency, in hertz, at the end of the transient surge/sag event and after a time specified by T(ime).
Rep(eat)	Sets the number of times the surge/sag transient event will be repeated before execution will proceed to the next event or exit the transient list. The number of times the transient event is generated is equal to the value, REPEAT+1. The value should be zero if only one execution of this event in the list is desired.
Func(tion)	Selects the waveform to be used during this section of the transient sequence. Each section could use a different waveform from the available library of user-defined waveforms or from the three standard waveforms. The output waveform changes upon entry into each section and remains in effect for the duration of the section. The default waveform is always the SINE (sinewave).
Trig(ger)	Causes a trigger pulse to be generated for the selected event when LIST is selected for Trig(ger) Outsource in the SETTINGS menu.

Delay	Sets the time duration, in seconds or cycles, that the voltage amplitude and frequency will stay at the levels, To V(olts) and to F(requency), before the next transient event is executed, or the transient list is completed.
Save	Completes the transient editing. All data fields should be entered before saving. The event number is automatically set based on the selection of either BEFORE or AFTER in the VIEW menu and will be a value between 0 and 99. The event number determines the order of execution of the events in a multiple event transient.
Phase	Displays the phases that had been selected in the Settings menu.

4.5.4.10 DELAY Sub-Menu

The VOLT/FREQ DELAY menu allows introducing a delay as a transient event. Refer to Figure 4-34. When the transient definition is complete, tap SAVE to store the transient step settings in non-volatile memory and return to the ADD menu.

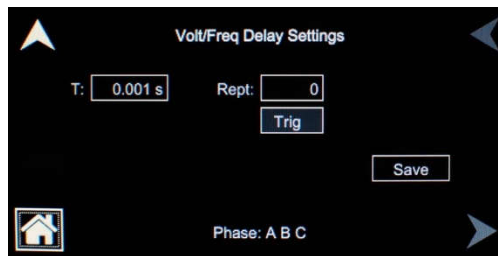

Figure 4-34. VIEW Menu, DELAY Sub-Menu

The VOLT/FREQ sub-menu has the following fields:

Entry	Description
T(ime)	Sets the time, in seconds or cycles, that the voltage amplitude and frequency will stay at their existing levels, before the next transient event is executed or the transient list is complete.
Rep(ea)t	Sets the number of times the surge/sag transient event will be repeated before execution will proceed to the next event or exit the transient list. The number of times the transient event is generated is equal to the value, REPEAT+1. The value should be zero if only one execution of this event in the list is desired.
Trig(ger)	Causes a trigger pulse to be generated for the selected event when LIST is selected for Trig(ger) Outsource in the SETTINGS menu.
Save	Completes the transient editing. All data fields should be entered before saving. The event number is automatically set based on the selection of either BEFORE or AFTER in the VIEW menu and will be a value between 0 and 99. The event number determines the order of execution of the transient events in a multiple event transient.
Phase	Displays the phases that had been selected in the Settings menu.

4.5.4.11 RUN Menu

The RUN menu is used to control transient execution; refer to Figure 4-35. It provides two selections, CONTINUOUS and X TIMES, and START/ABORT functions to begin and stop execution of a list.

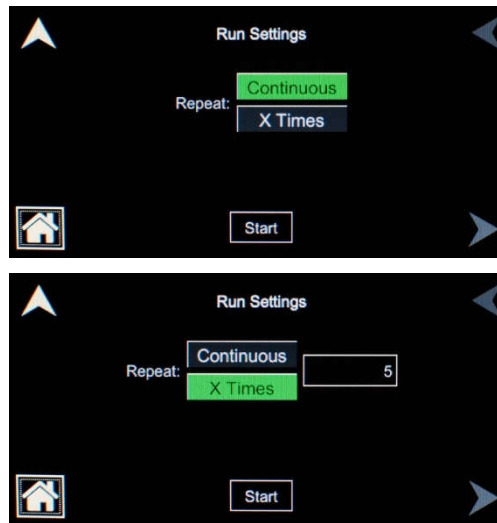

Figure 4-35. RUN Menu

The RUN menu has the following fields:

Entry	Description
Continuous	Causes the transient execution to continue indefinitely. The execution must be stopped manually.
X Times	Determines the number of times a transient list is repeated. The default value is zero, which means the programmed list runs only once. The range for this field is from 0 to 99999. This repeatable function should not be confused with the REPEAT function available for individual events. The event-specific repeat value will cause only that event to be repeated, not the entire list.
Start	Starts a transient execution. The relay output must be closed, or an error message will appear, and the transient will not start.
Once	Once the START command has been set, the START selection-button will change to an ABORT button, which could be used to stop the run and abort the transient list.

4.5.5 CONFIGURATION Screen

The CONFIGURATION screen provides setup of output mode of operation, power-on states, operation profiles, parameter limits, and selection of clock mode and XLOAD.

The top-level menu of the CONFIGURATION screen is shown in Figure 4-36. It can be reached in one or two ways:

1. Tapping CONFIGURATION on Home Screen of the front panel touchscreen;
2. Scrolling to CONFIGURATION with the encoder and depressing the encoder switch.

The UP-arrow button will return back to the previously selected screen menu (in this case the Home Screen). The HOME button will return back to the home screen that has the top-level menu for the sub-menu being displayed; for the CONFIGURATION screen top-level menu, which is the HOME Screen.

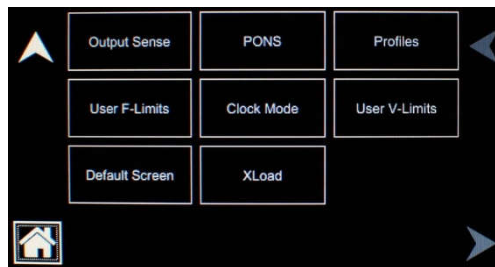
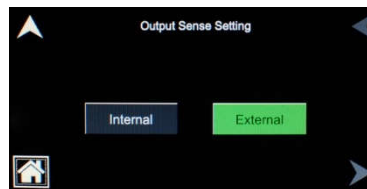

Figure 4-36. CONFIGURATION Screen Top-Level Menu

The following sub-menus are available on the CONFIGURATION menu:

Entry	Description
OUTPUT SENSE	<p>Selects the point for the sensing of the output voltage for regulation; the default is external:</p> <p>Internal: Local, at the rear panel terminals;</p> <p>External: Remote, through the Remote Sense connection to the load.</p>



PROFILES	<p>Selects the operational state of the power source; the default is Profile-0. Up to 15 unique profiles, including transient lists, could be stored; refer to Figure 4-37. Subsequently, a profile could be loaded to automatically set the unit to that particular configuration. To save the present state, tap on a profile selection button. The profile could be given an alpha-numeric identifier by using the Name function; refer to Figure 4-38. Tap the SAVE field to store the present configuration. Tap on the Load field to recall a configuration and set the power source to that state.</p>
-----------------	---

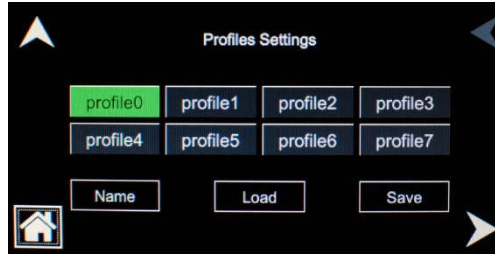

Figure 4-37. CONFIGURATION Menu, PROFILES Sub-Menu

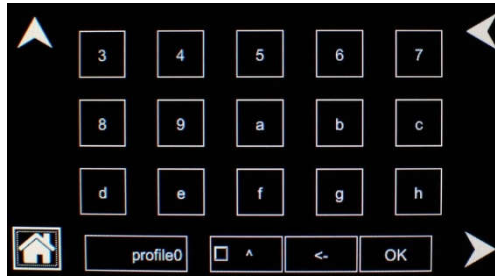
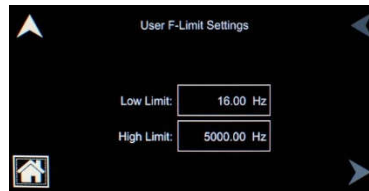

Figure 4-38. PROFILES Menu, NAME Sub-Menu

USER F-LIMITS

Sets soft-limits for the minimum and maximum output frequency to which the unit could be programmed using the front panel or remote digital interface; default is full-scale.



CLOCK MODE

Selects the source for the synchronization of the output frequency; default is Internal:

Internal: Derives synchronization from the internal waveform generator;

SYNC: Derives synchronization from the user interface SYNC signal; available only in a Standalone unit or Master unit.

External: Derives synchronization from the external Clock/Lock interface; available only in the Auxiliary unit with the Clock/Lock option, LKS; for multi-phase operation, the Auxiliary unit must have the setting at External.

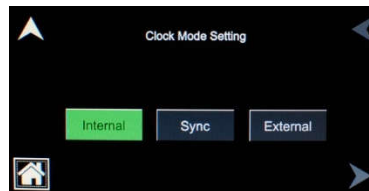

USER V-LIMITS

Sets soft-limits for the minimum and maximum output voltage to which the unit could be programmed using the front panel or remote digital interface; default is full-scale.

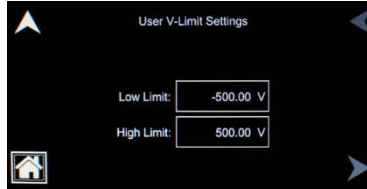

DEFAULT SCREEN

Selects whether the Default screen (showing only voltage and current amplitude) is enabled and configures its operational characteristics; the defaults are Default screen enabled, 10 second timeout.

Timeout Interval: Selects the time, in seconds, for how long a screen must be inactive before the Default screen is displayed.

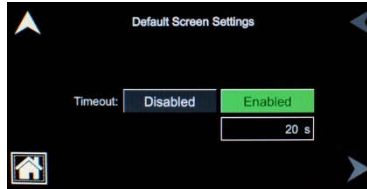

X LOAD

The Asterion power source is stable with load power factors from 0-leading to 0-lagging. The most difficult road is driving large capacitive loads. Though stable with its normal feedback controller compensation, additional stability margin could be achieved for unusual loads by turning on XLOAD. This significantly improves the transient response of the amplifier, but it should only be used for reactive loads, and with programmed frequencies of less than 1200 Hz.

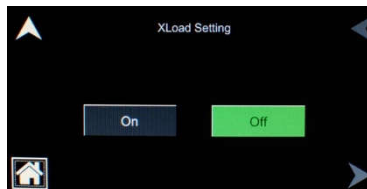

PONS

The PONS menus allow setting the conditions that would be present after power up; refer to Figure 4-39. The AC input has to be cycled off/on for a change in a PONS setting to take effect. The functions and parameters have the same programmability as described in the menus of the OUTPUT PROGRAM screen; refer to Section 4.5.2.



CAUTION! The PONS menus allow selecting that the output would be turned on and programmed to a high voltage, when the unit is initially powered up. Ensure that suitable protection is provided to prevent accidentally energizing the load. The factory-default setting is with the output off and programmed to zero to provide the safest start-up condition.

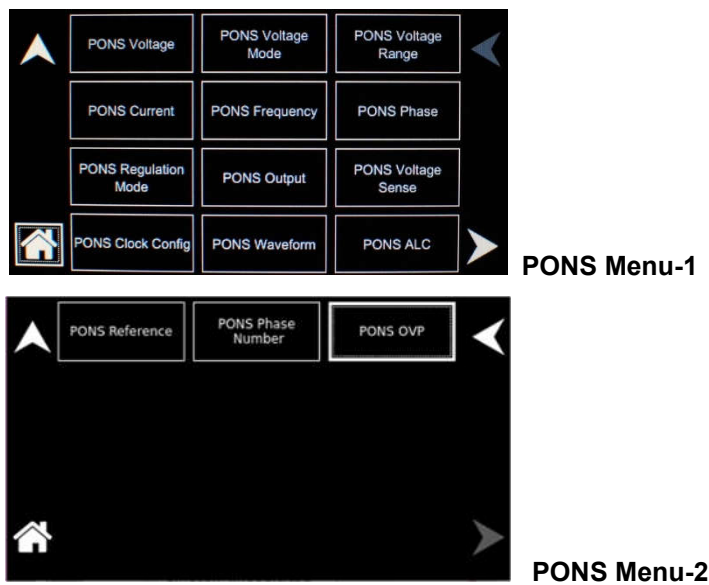
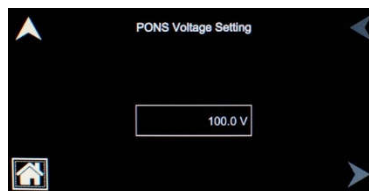

Figure 4-39. CONFIGURATION Menu, PONS Menu-1/2

The PONS menu has the following fields:

<u>Entry</u>	<u>Description</u>
PONS VOLTAGE	<u>PONS menu:</u> Sets the value of the output voltage; the default is zero.



PONS VOLTAGE MODE

PONS menu: Selects the mode of operation for the output voltage of the power source: either AC only, DC only, or AC with a DC offset, AC+DC; the default is AC.

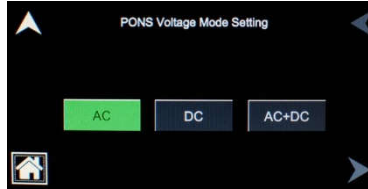

PONS VOLTAGE RANGE

PONS menu: Selects the output voltage range, either low-range, 200 VAC or 250 VDC, or high-range, 400 VAC or 500 VDC. The available ranges are dependent on the selection of the VOLTAGE MODE, either AC, DC, or AC+DC; the default is low-range, 200 VAC.

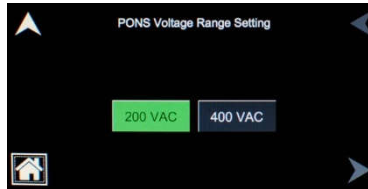

PONS CURRENT

PONS menu: Sets the value of the output current; the default is full-scale for the model.

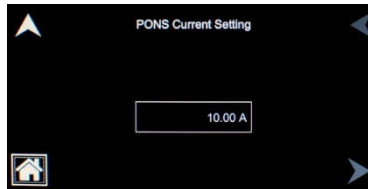

PONS FREQUENCY

PONS menu: Sets the value of the output frequency; the default is 60 Hz.

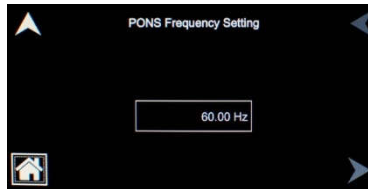

PONS PHASE

PONS menu: Sets the phase of the output voltage in relation to the external synchronization signals, SYNC or Clock/Lock; the default is zero.

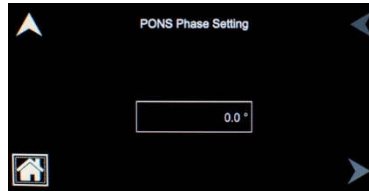

PONS REGULATION MODE

PONS menu: Selects either Current-Limit mode (CL), where the output would be shut down when the current reaches the set value, or Constant-Current mode (CC), where the output current would be regulated when it reaches the set value; the default is Current-Limit.

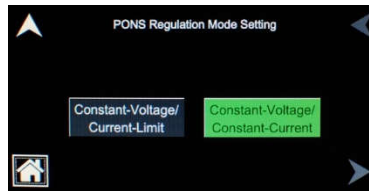

PONS OUTPUT

PONS menu: Selects whether the output is turned on or off when the unit is powered up. If output-on is selected, the output voltage will be programmed to the value sets in the PONS VOLTAGE sub-menu; the default is off.

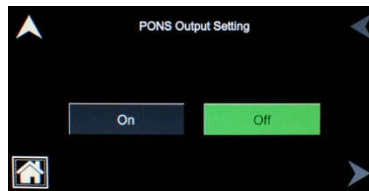

PONS VOLTAGE SENSE

PONS menu: Selects the point for the sensing of the output voltage for regulation, either Internal (local, at the rear panel terminals) or External (remote, through the Remote Sense connection to the load); the default is External.

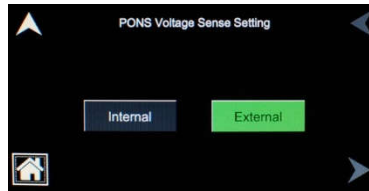

PONS CLOCK CONFIG

PONS menu: Configures the synchronization of the output frequency and phase, depending on whether the unit is operating Standalone (also applicable to the Master of a parallel group), as a Master of a multi-phase group, or as an Auxiliary of a multi-phase group:

Standalone: Derives synchronization from either the user interface SYNC signal, or the internal waveform generator (with full frequency resolution), as selected in the PONS CLOCK MODE menu (either Internal or SYNC).

Master: Derives synchronization from either the user interface SYNC signal or the internal waveform generator (with internal synchronization, the phase programming resolution is limited to 1 Hz), as selected in the PONS CLOCK MODE menu (either SYNC or Internal); this setting is available only with the Clock/Lock option, LKM; for multi-phase operation, the Master unit must have the setting at Master.

Auxiliary: Derives synchronization from either the internal waveform generator or the external Clock/Lock interface (with external synchronization, the phase programming resolution is limited to 1 Hz), as selected in the PONS CLOCK MODE menu (either Internal or External); this setting is available only with the Clock/Lock option, LKS; for multi-phase operation, the Auxiliary unit must have the setting at Auxiliary.



PONS WAVEFORM

PONS menu: Selects the type of output waveform, either the standard sine, square, or clipped sine, or one that is user-defined; the default is sine wave. The clipped-sine waveform has an additional programmable parameter, CLIP % THD, Refer to Section 4.5.2 for information on use of the menus.

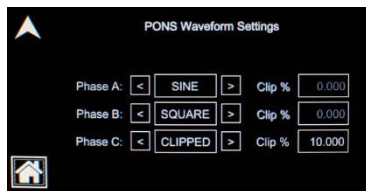

PONS ALC

PONS menu: Selects how the output voltage will be regulated; default is ALC on:

ON: The RMS digital regulator is enabled, and shutdown will be executed if loss of regulation occurs;

OFF: Regulation of the output voltage does not utilize the RMS digital regulator, and shutdown that is dependent on regulation would not occur;

Regulate: The RMS digital regulator is enabled, but shutdown will not be executed if loss of regulation occurs.



PONS REFERENCE

PONS menu: Selects either the internal waveform generator or the external analog inputs for programming the output waveform and amplitude; the default is Internal:

Internal: Enables the internal waveform generator using the standard waveforms or one of the user-defined waveforms;

External: Enables the external analog interface programming input that sets waveform and amplitude.

RPV: Enables the external analog interface programming input that sets the amplitude, while the internal waveform generator is used to set the waveform.

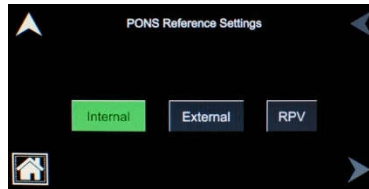

PONS PHASE NUMBER

PONS menu: Selects the output configuration, either 1-Phase or 3-Phase, for 3-Phase models; the default is 3-Phase.

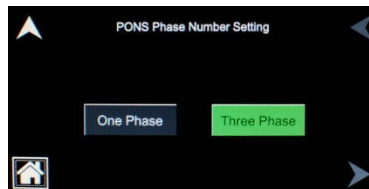

PONS OVP

PONS menu: Programs the Overvoltage Protection (OVP) threshold for the output voltage of each output phase when the unit is powered up. Exceeding the OVP threshold will result in shutdown of the output, with the output isolation relay opened and the output voltage programmed to zero. The maximum OVP setpoint is 115% of full-scale low-range/high-range output voltage: AC-Mode and (AC+DC)-mode, 230V/430V; DC-Mode, 287.5V/575V. The default value is 115% of full-scale.

When Output Voltage Range (set through DASHBOARD screen or OUTPUT PROGRAM sub-menu) is set at Low Range only the Low Range field box within the PONS OVP screen would be active and enabled whereas the High Range field box would be disabled and grayed out.

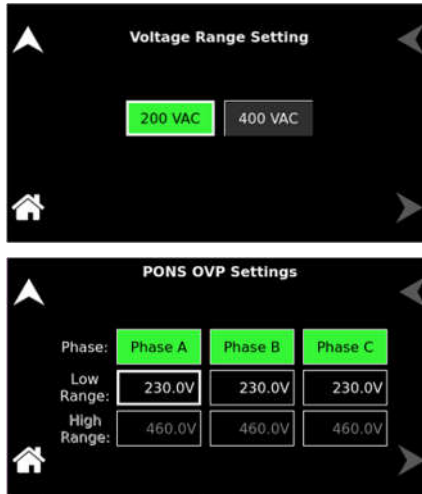

When Output Voltage Range (set through DASHBOARD screen or OUTPUT PROGRAM sub-menu) is set at High Range only the High Range field box within the PONS OVP screen would be active and enabled whereas the Low Range field box would be disabled and grayed out.

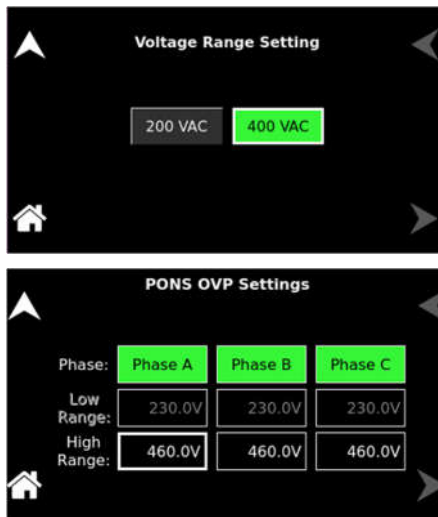

4.5.6 CONTROL INTERFACE Screen

The CONTROL INTERFACE screen provides the ability to configure the power source for remote control through the data communications interfaces, and also to set up the functionality of the Remote Inhibit signal. For detailed information on setting up the data communications digital interfaces, including the USB, using the Asterion Virtual Panels or SCPI commands, refer to the Asterion Series Programming Manual P/N M330100-01 (distributed on the CD, CIC496), or refer to the AMETEK Programmable Power website, www.programmablepower.com, to download latest versions.

The top-level menu of the CONTROL INTERFACE screen is shown in Figure 4-40. It could be reached in one or two ways:

1. Tapping CONTROL INTERFACE on Home Screen of the front panel touchscreen;
2. Scrolling to CONTROL INTERFACE with the encoder and depressing the encoder switch.

The UP-arrow button will return back to the previously selected screen menu (in this case the Home Screen). The HOME button will return back to the home screen that has the top-level menu for the sub-menu being displayed; for the CONTROL INTERFACE screen top-level menu, which is the HOME Screen.



Figure 4-40. CONTROL INTERFACE Screen

The following sub-menus are available on the CONTROL INTERFACE menu:

Entry	Description
ANALOG	<p>Selects the reference that determines the output voltage waveform and amplitude; the default is INT. Refer to Figure 4-41. The options are as follows:</p> <p>INT: Selects programming of the output voltage waveform and amplitude by the internal controller reference.</p> <p>RPV: Selects programming of output voltage amplitude with an external analog interface signal, with the waveform being set by the internal controller reference. A Voltage field is provided for entry of DC signal range: user-selectable maximum range value within 2.5 VDC to 10 VDC, for full-scale RMS of internally programmed output voltage waveform.</p> <p>EXT: Selects programming of output voltage waveform and amplitude with an external analog interface signal. A Voltage field is provided for entry of AC or DC input signal range: 0V to user-selectable maximum range value within 2.5 V(PK) to 10 V(PK), corresponding to maximum range of 1.77 V(RMS) to 7.07 V(RMS), for zero to full-scale RMS output voltage; with AC waveform, from 16 Hz to 5 kHz (option dependent);</p> <p>PHASE: Selects the full-scale of the analog programming voltage for each output phase (Phase-A/B/C).</p>

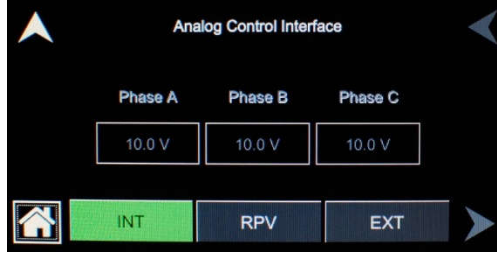

Figure 4-41. CONTROL INTERFACE Menu, ANALOG Sub-Menu

RS232

Configures the RS-232C communications interface; refer to Figure 4-42. These settings must match those set for the communications port of the user external controller. The setup parameters are as follows:

Baud Rate: sets baud rate to either 9600, 19,200, 38,400, 57600 or 115,200 baud. The default setting is 115,200 baud;

Data: sets the number of data bits to either 7 or 8. The default setting is 8 bits;

Parity: sets the parity to either Even, E, Odd, O, or no parity, N. The default setting is no parity, N;

Stop Bits sets the number of stop bits to either 1 or 2 bits. The default setting is 1 stop bit;

Start Bits: always set to 1;

Terminator for Received Messages: LF (ASCII 13) is necessary, but CR/LF (ASCII 10 / ASCII 13) would be accepted;

Terminator for Transmitted Messages: LF (ASCII 13);

Flow Control: available hardware handshake RTS/CTS; utilization is recommended, but not mandatory.

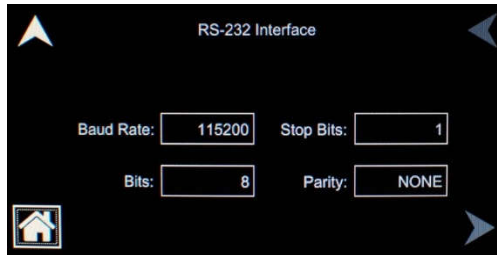

Figure 4-42. CONTROL INTERFACE Menu, RS232 Sub-Menu

GPIB

Sets the IEEE-488 address; the default is 1. The address could be set from 0 through 31, though address 0 is often reserved for the IEEE-488 external controller; refer to Figure 4-43.



Figure 4-43. CONTROL INTERFACE Menu, GPIB Sub-Menu

LAN

Configures the LAN (Ethernet) communications interface; refer to Figure 4-44. After settings are changed, the unit must be turned off/on for them to take effect.



Figure 4-44. CONTROL INTERFACE, LAN Menu

The following sub-menus are available on the LAN menu:

Entry	Description
LAN SETTINGS	Lists the configuration settings of the LAN interface, and the DNS-SD service name; a number, (n), would be appended to the service name, if necessary, to differentiate duplicate power source names.



LAN CONFIGURE

Sets parameter values and controls operation of the LAN interface; refer to Figure 4-45.



Figure 4-45. CONTROL INTERFACE, LAN CONFIGURE Sub-Menu

IP Address: sets the IP address, when DHCP is turned off in the LAN CONFIG sub-menu (see below); when AUTO IP is selected, set the IP address to all zeros so that the IP address would be requested from the network; when DHCP is selected, the IP address is assigned by the network DHCP server.

Subnet Mask: sets the subnet mask, when DHCP is turned off in the LAN CONFIG sub-menu (see below);

Gateway Address: sets the gateway address when DHCP is turned off in the LAN CONFIG sub-menu (see below); when AUTO IP is selected, set the gateway address to all zeros so that the gateway address would be requested from the network; when DHCP is selected, the gateway address is assigned by the network DHCP server.

Port: sets the port number; the factory-default value is 5025.



IP Address

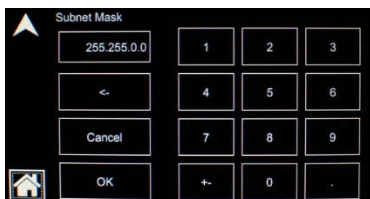

Subnet Mask

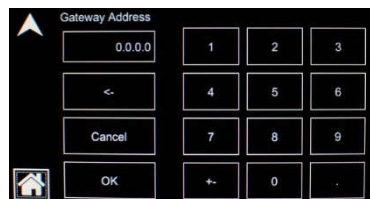

Gateway Address

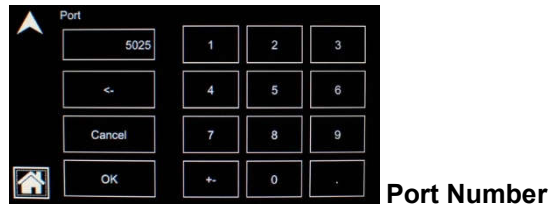

MAC Address: displays the MAC address; the MAC address is listed on a label on the chassis of the unit.



Host Name: allows setting a unique alpha-numeric hostname.



LAN CONFIG: selects whether DHCP and Auto-IP are enabled.

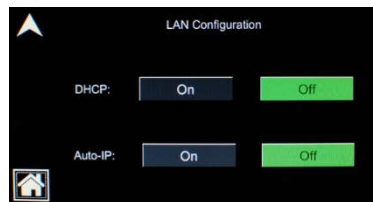

Restore Default performs an LXI reset to default settings.

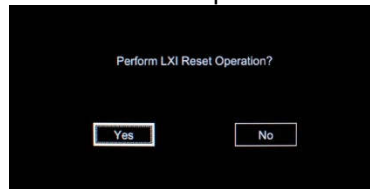

REMOTE INHIBIT

Configures the external Remote Inhibit signal, between /INHIBIT_ISO (Pin-12) and ISO_COM (Pin-9), for turning the output on/off; refer to Figure 4-46, and Section 3.12.2 for a detailed description. The default settings are Live and Low logic-level.

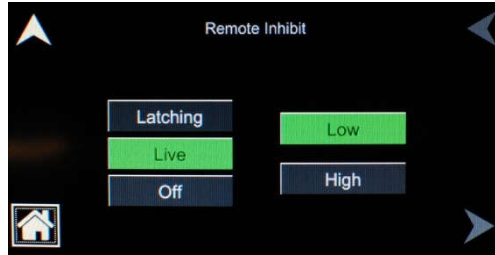

Figure 4-46. CONTROL INTERFACE REMOTE INHIBIT Menu

Latching: a TTL logic signal at the external Remote Inhibit input latches the output in the shutdown state; when the output is turned off, it is programmed to zero volts and the output relays are opened; this state could only be cleared by the remote digital interface SCPI command, OUTPUT:PROTECTION:CLEAR;

Live: the output state follows the state of the external Remote Inhibit input, turning the output on/off;

Low/High selects the logic level of the Remote Inhibit signal that would cause the output to be turned off: either a logic-low or contact closure, or a logic-high or open-circuit.

Off: the power source ignores the external Remote Inhibit input.

4.5.7 PROTECTION Screen

The PROTECTION screen provides access to the OVP protection supervisory monitor for the output voltage of the power source.

The top-level menu of the PROTECTION screen is shown in Figure 4-47. It can be reached in one or two ways:

1. Tapping PROTECTION on Home Screen of the front panel touchscreen;
2. Scrolling to PROTECTION with the encoder and depressing the encoder switch.

The UP-arrow button will return back to the previously selected screen menu (in this case the Home Screen). The HOME button will return back to the home screen that has the top-level menu for the sub-menu being displayed; for the PROTECTION screen top-level menu, which is the HOME Screen.



Figure 4-47. PROTECTION Screen

The following sub-menus are available on the PROTECTION menu:

Entry	Description
Settings	
OVP	Programs the Overvoltage Protection (OVP) threshold for the output voltage of each output phase. Exceeding the OVP threshold will result in shutdown of the output, with the output isolation relay opened and the output voltage programmed to zero. The maximum OVP setpoint is 115% of full-scale low-range/high-range output voltage: AC-Mode and (AC+DC)-mode, 230V/430V; DC-Mode, 287.5V/575V. The default value is 115% of full-scale.



4.5.8 APPLICATIONS Screen

The APPLICATIONS screen provides access to the optional applications specific pre-programmed functions and features that are installed in the unit.

The top-level menu of the APPLICATIONS screen is shown in Figure 4-48. It can be reached in one or two ways:

2. Tapping APPLICATIONS on Home Screen of the front panel touchscreen;
3. Scrolling to APPLICATIONS with the encoder and depressing the encoder switch.

The UP-arrow button will return back to the previously selected screen menu (in this case the Home Screen). The HOME button will return back to the home screen that has the top-level menu for the sub-menu being displayed; for the APPLICATIONS screen top-level menu, which is the HOME Screen.



Figure 4-48. APPLICATIONS Screen, Output Impedance Example

4.5.9 SYSTEM SETTINGS Screen

The SYSTEM SETTINGS screen provides information on versions of firmware and which options are installed. It also allows for selecting the language used for the display, setting the LCD brightness, performing calibration of the touchscreen, and setting hardware limits.

The top-level menu of the SYSTEM SETTINGS menu is shown in Figure 4-49. It can be reached in one or two ways:

1. Tapping SYSTEM SETTINGS on Home Screen of the front panel touchscreen;
2. Scrolling to SYSTEM SETTINGS with the encoder and depressing the encoder switch.

The UP-arrow button will return back to the previously selected screen menu (in this case the Home Screen). The HOME button will return back to the home screen that has the top-level menu for the sub-menu being displayed; for the SYSTEM SETTINGS screen top-level menu, which is the HOME Screen.

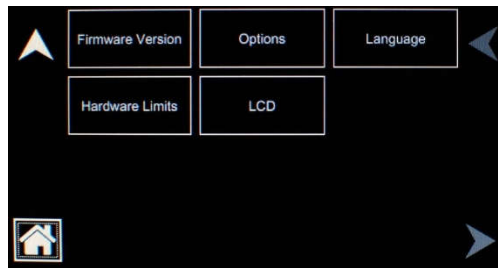

Figure 4-49. SYSTEM SETTINGS Screen

The following sub-menus are available on the SYSTEM SETTINGS menu:

Entry	Description
FIRMWARE VERSION	Displays information about the configuration of the power source. It has information such as manufacturer, model number, serial number and firmware version. This information helps identify the unit and options installed.



OPTIONS	Displays options that have been installed in the power source.
----------------	--



LANGUAGE

Selects the language of the display menus: English, German, French, Russian, Japanese, Chinese, or Korean.



HARDWARE LIMITS

Displays the parameter limit values that are asserted at power-on.



LCD

Provides settings for the LCD brightness and calibration of the display touchscreen; refer to Figure 4-50.

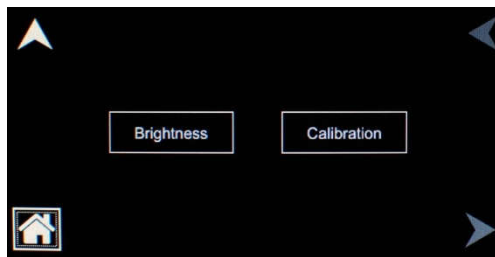
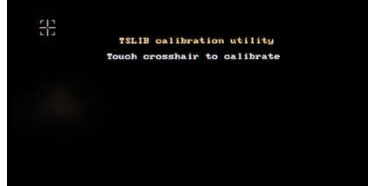

Figure 4-50. SYSTEM SETTINGS Menu, LCD Menu

Brightness: sets the brightness of the LCD backlight, as a percentage of the maximum that is available; the default setting is 70%. Tapping on the Right or Left arrow buttons or selecting them with the encoder and clicking the encoder switch, will increment/decrement the brightness by 10%, respectively.



Calibration: enables the calibration routine for the display touch-screen; the calibration is run by tapping the displayed target, as instructed on the display. The touchscreen depends on pressure being applied to the top surface of the screen to detect the position of input. A fingertip, fingernail, or stylus pen could be used. To prevent scratching the surface layer, do not use a hard or sharp tip, such as ball-point pen or mechanical pencil.



5. Waveform Management

The Asterion Series power source incorporates an arbitrary waveform generator that allows the user to create custom waveforms (up to 50) and download them into the memory of the unit. In addition, three standard waveforms are always available: sine wave, square wave, and clipped-sine wave. The full capability of waveform management could be programmed through the remote digital interface using the Asterion Virtual Panels or SCPI commands. Refer to the Asterion Series Programming Manual P/N M330100-01 (distributed on the CD, CIC496), or refer to the AMETEK Programmable Power website, www.programmablepower.com, to download latest versions.

5.1 Standard Waveforms

For many AC applications, the sine wave is the prevalent waveform that is used. Therefore, it is one of the standard waveforms provided in the power source and is the default waveform at power-on. In addition to the sine wave, two more standard waveforms are available, square wave and clipped-sine wave.

The square wave provides fast rise and falls times, with high harmonic content. Due to the power stage amplifier bandwidth limitations, the frequency content of the standard square wave is restricted to be within the capabilities of the amplifier. As the fundamental frequency is increased, the relative contribution of higher harmonics is reduced.

The clipped-sine wave may be used to simulate voltage distortion levels to the unit under test. The total harmonic distortion level may be programmed in percent using the CLIP % THD field of the WAVEFORMS menu of the OUTPUT PROGRAM screen; refer to Section 4.5.2. Changing the distortion level of the waveform through the display menu forces the power source to regenerate the data points of the clipped-sine wave, and reload the waveform register with the newly requested data; this process requires the output to be programmed to zero. To avoid interrupting the output voltage to the unit under test, SCPI commands could be used through the digital interface to select a different waveform such as the standard sine wave first, change the CLIP LEVEL, and then change the waveform back to the clipped-sine wave.

5.2 Creating Custom Waveforms

The Asterion Series power source provides a library of four waveform groups (numbered 0 through 3), each containing 50 custom-defined waveforms for a total of 200 waveforms, in addition to the three standard waveforms. Of these four groups, only one could be active at a time. With front panel control, only the waveform group that was present at power-on could be accessed. The available waveforms could be selected through the WAVEFORMS menu of the OUTPUT PROGRAM screen; refer to Section 4.5.2.

Custom waveforms cannot be created or deleted from the front panel of the power source. Instead, this must be accomplished through the remote digital interface. The standard waveforms permanently reside in memory and could not be deleted. A Windows-based graphical user interface program, Virtual Panels, is available with a power source that allows waveforms to be created and downloaded easily. Virtual Panels allow waveforms to be created by specifying harmonic amplitudes and phase angles with respect to the fundamental. It also offers an arbitrary waveform data entry mode that allows individual data points to be specified. For detailed information on creating waveforms, refer to the Asterion Programming Manual P/N M330100-01 (distributed on the CD, CIC496), or refer to the AMETEK Programmable Power website, www.programmablepower.com, to download latest version.

5.2.1 Viewing Custom Waveforms on the Display

Information on user-defined, custom waveforms could be viewed on the display using the HARMONICS menu of the OUTPUT PROGRAM screen; refer to Section 4.5.2. The harmonics could be displayed either in a tabular form or a bar graph. Refer to Figure 5-1 for an example of the information on the waveform that could be derived from the display. After loading a waveform, and programming the output with it, the TRACE CAPTURE screen of the MEASUREMENTS menu could be used to view it in real-time; refer to Section 4.5.3,

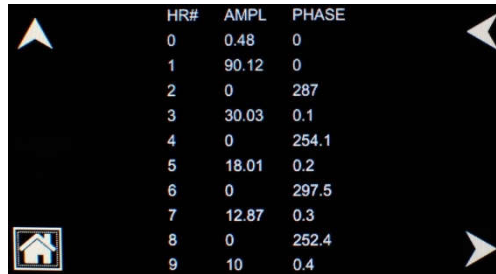

HR#	AMPL	PHASE
0	0.48	0
1	90.12	0
2	0	287
3	30.03	0.1
4	0	254.1
5	18.01	0.2
6	0	297.5
7	12.87	0.3
8	0	252.4
9	10	0.4

TABLE Sub-Menu

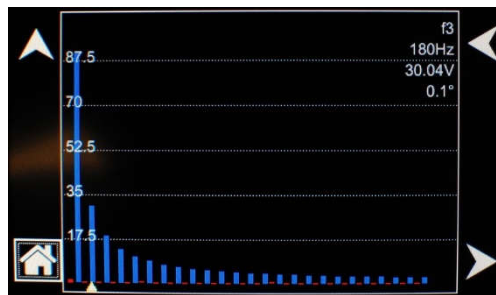

BAR Sub-Menu

Figure 5-1. HARMONICS Screen, Waveform Information

5.3 RMS Amplitude Restrictions

The maximum RMS value that could be programmed within a voltage range is dependent on the crest factor of the output voltage waveform due to constraints of the power stage amplifier on producing the peak voltage. The voltage range limit is based on a sine wave with a crest factor of 1.414: for example, in the High-Range, the full-scale AC sine wave voltage of 400 V(RMS) has a peak voltage of 566 V(PK), and that is the maximum peak voltage that could be produced for any other type of waveform. Therefore, if a custom waveform is used and the crest factor is greater than 1.414, the maximum programmable RMS voltage would be less than the maximum range value in order to stay within the peak voltage limit.

The power source automatically limits the maximum allowable programmed RMS voltage of any custom waveform by calculating the crest factor of the selected waveform to ensure that the peak output voltage capability is not exceeded and controlling the RMS limit accordingly. Therefore, each custom waveform might have a different maximum RMS value. The power source controller will prevent the user from programming the RMS voltage above this limit. If a value is entered above this value, a “Voltage peak error” message is generated.

If the power source is controlled through the remote digital interface, the SCPI query command, :VOLT? MAX could be used to determine the maximum allowable RMS voltage for the selected waveform. The query returned value could be used as part of a program to preclude range errors.

5.4 Frequency Response Restrictions

The user could create a waveform that contains any number of harmonic frequencies of the fundamental. However, the power source has a finite signal bandwidth and would attenuate frequency components of the signal that exceed that bandwidth. To limit the high frequency components of the output signal, the power source controller automatically applies a band-pass filter to all custom waveforms as they are downloaded. The power source controller implements the following process for user-defined waveforms:

Each downloaded waveform will have a computed frequency limit that is less than or equal to the maximum frequency limit of the power source. The frequency limit is a function of the harmonic content of the waveform and is derived from the following relation:

$$F_{\text{harmonic}} \leq (V_{\text{full-scale}} \times F_{\text{maximum}}) / (V_{\text{harmonic-amplitude}} \times \text{harmonic-number}),$$

where, F_{harmonic} = harmonic frequency,
 $V_{\text{full-scale}}$ = the full-scale rated voltage,
 F_{maximum} = the full-scale fundamental frequency,
 $V_{\text{harmonic-amplitude}}$ = the amplitude of the harmonic,
harmonic-number = the multiple of the full-scale fundamental frequency.

The limits that are set assume a program of full-scale output voltage. There are no accommodations for voltage settings made below the full-scale value. Waveform selection and frequency programming will be subject to the limit. If the F_{harmonic} parameter is above the minimum limit value, the waveform will be rejected at time of download, the entry label will be deleted from the waveform library, and an error message will be generated.

If the power source is controlled through the remote digital interface, the SCPI query command, :FREQ? MAX could be used to determine the maximum allowable fundamental frequency for the selected waveform. The value returned for the query could be used as part of a program to preclude range errors.

5.5 Transient List Waveforms

Waveforms can be selected as part of a transient list. Each setup menu of a transient type has a FUNCTION field that allows selection of any of the standard or user-defined custom waveforms available in the active waveform group (one of the four, 0-3). The active group is the one loaded at power-on or selected by SCPI commands through the remote digital interface. For more details on selecting output waveforms within transient lists refer to the Section 4.5.4.

6. Standard Measurements

The Asterion Series power source is continuously sampling the instantaneous output voltage and current and storing the data in a buffer that holds 4096 voltage and current data points (frame). The data is used to calculate the values of the parametric measurements, with two cycles of measurement required to derive an RMS value. The voltage and current are sampled at two rates, 93.75 ksp/s or 31.25 ksp/s, depending on output frequency. At ≥ 48 Hz, the sample rate is 93.75 ksp/s, giving a derivation time of 43.69 ms per frame. There is hysteresis of 4 Hz in switching to the lower sample rate, so at ≤ 44 Hz, the sample rate is reduced to 31.25 ksp/s, and the time required per frame is 131 ms.

Measurement of output parameters is available in either the MEASUREMENTS screen (refer to Section 4.5.3) or the DASHBOARD screen (refer to Section 4.5.1). The MEASUREMENTS screen allows only for the display of measurements, and provides either a group display of parameters, or a dedicated screen for each parameter that could be selected when a single parameter is of concern. The DASHBOARD screen provides display of voltage, current, and frequency, as well as the ability to set their values. The full extent of the measurement's capability could be accessed through the remote digital interface using SCPI commands or the Asterion Virtual Panels. Refer to the Asterion Series Programming Manual P/N M330100-01 (distributed on the CD, C1C496), or refer to the AMETEK Programmable Power website, www.programmablepower.com, to download latest versions.

6.1 Parameter Measurements

The output mode of operation, whether AC, DC, or AC+DC, determines which parameters are available in the MEASUREMENTS screens, as shown in Table 6-1.

Parameter	Output Mode of Operation		
	AC	DC	AC+DC
VOLTAGE	RMS of AC voltage	RMS voltage	RMS voltage
CURRENT	RMS of AC current	RMS current	RMS current
FREQUENCY	Frequency	N/A	Frequency
REAL POWER	Real power	Real power	Real power
APPARENT POWER	Apparent power	Apparent power	Apparent power
PHASE	Phase angle	N/A	Phase angle
POWER FACTOR	Power factor	N/A	Power factor
CREST FACTOR	Crest factor	N/A	Crest factor
VOLTAGE THD	%THD	N/A	%THD
CURRENT THD	%THD	N/A	%THD
ENERGY	Watt-Hour	Watt-Hour	Watt-Hour

Table 6-1. MEASUREMENTS Screen Parameters

The output voltage mode also determines how parameter value measurements are derived, and how the measurement signals are internally coupled, whether AC or DC; refer to Table 6-2.

Operating Voltage Mode	Measurement Value	Measurement System Signal Coupling
AC	RMS of AC component	AC
DC	Total RMS, AC plus DC components	DC
AC+DC	Total RMS, AC plus DC components	DC

Table 6-2. MEASUREMENTS Parameter Value Derivation**6.1.1 Accuracy Considerations**

When using the power source for measurement purposes, always consider the accuracy specifications when interpreting results. Measurement inaccuracies become more pronounced as the signal being measured is at the low end of the measurement range. This is particularly relevant for low current measurements. The Asterion Series power source develops high levels of output power, and, accordingly, is optimized for providing and measuring high load currents. When supplying low power loads, measurement inaccuracies on RMS and peak current values will also affect other parameters that are derived from those measurements, such as power, power factor and crest factor.

The measurement system of the power source uses a data acquisition system with a 47 kHz bandwidth. This means that high frequency components of the measured signal are filtered out. Any contribution to the RMS value of voltage and current components above the filter cutoff frequency would not be reflected in the measurements. Accordingly, voltage and current measurements of waveforms with significant harmonic content at high frequencies would incur additional error. Refer to AMETEK Programmable Power website, www.programmablepower.com, to download latest version.

6.2 Advanced Measurements

The Asterion Series power source offers advanced power analyzer measurement capabilities through DSP-based digitization of the output voltage and current waveforms. These functions may be accessed through the menus of the MEASUREMENTS screen. The full capability of advanced measurements could be accessed through the remote digital interface using the Asterion Virtual Panels or SCPI commands. Refer to the Asterion Series Programming Manual P/N M330100-01 (distributed on the CD, CIC496), or refer to the AMETEK Programmable Power website, www.programmablepower.com, to download latest version.

6.2.1 Harmonic Analysis

The power source analyzer performs a fast Fourier transform (FFT) on both voltage and current. The resulting frequency spectrum (DC through 49th harmonic) can be displayed on the LCD display in a tabular as well as a graphical format.

6.2.2 Acquiring FFT data

To perform an FFT analysis on the output of the power source using the front panel display, proceed as follows:

1. Navigate to the HARMONICS menu of the MEASUREMENTS screen; refer to Figure 6-1.

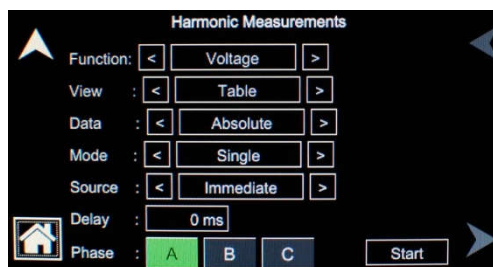
**Figure 6-1. HARMONICS Menu**

2. Scroll to the FUNCTION field and select VOLT or CURRENT.
3. Scroll to the VIEW field and select the TABLE or BAR display mode.
4. Scroll to the DATA field and select ABSOLUTE or RELATIVE. The ABSOLUTE display format will show all harmonic components in volts or amps. The RELATIVE display format will use the fundamental as a 100% reference and display all harmonics as a percentage of the fundamental. Phase angles are always shown with respect to the fundamental frequency.
5. Tap the MODE field and select SINGLE or CONTINUE. The SINGLE mode will acquire the data once and show the result, while the CONTINUE mode will update the data continuously.
6. Tap the SOURCE field and select IMMEDIATE; alternate trigger mode is PHASE.
7. Tap Phase-A, Phase-B, or Phase-C button to select which output phase would be analyzed.
8. Tap the START field to start the analysis. The display mode that was selected will be opened and the results displayed. If the trigger mode, CONTINUE, was selected, the data will be continually updated.
9. Returning to the HARMONICS menu could be done by tapping the UP-arrow button. To display the data in a different format, the selections are changed as desired, and a new acquisition started by tapping the START field.

6.2.3 Analyzing FFT Data

The FFT results could be displayed for the entire data set using either the tabular or graphical formats. For tabular display, the harmonics are presented in five groups with ten harmonics per group. The LEFT and RIGHT buttons could be used to scroll through the data vertically; refer to Figure 6-2.

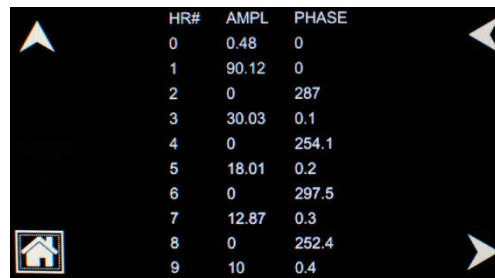

HR#	AMPL	PHASE
0	0.48	0
1	90.12	0
2	0	287
3	30.03	0.1
4	0	254.1
5	18.01	0.2
6	0	297.5
7	12.87	0.3
8	0	252.4
9	10	0.4

Figure 6-2. FFT data in Tabular Format

FFT data displayed in bar chart format shows the same data in a graphical format; refer to Figure 6-3. While the amplitude information is shown graphically, phase data is only displayed in numeric format at the right-side of the display. The display could show up to 25 harmonic components at a time. The triangle at the bottom of the display shows the currently selected component for which numeric data is shown on the right-side. This data includes the harmonic number (DC through 50), the harmonic frequency, the absolute or relative amplitude (depending on selection in DATA field), and the phase angle with respect to the fundamental. The rotary encoder could be used to scroll through the displayed harmonics horizontally, or the touchscreen could be used to directly select an individual harmonic.

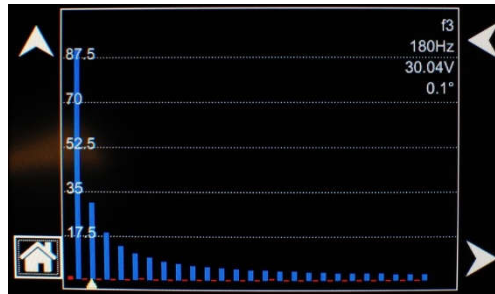

Figure 6-3. FFT data in Bar Graph Format

6.3 Triggering Measurements

Both FFT results and waveform acquisitions might have to be positioned at a specific instant in time. To allow the data acquisition to coincide with user specified events, the measurement system can be triggered in different ways. Trigger modes are available from both the digital interface and the front panel. Refer to the Asterion Series Programming Manual P/N M330100-01 distributed on the CD, CIC496, for details on this mode of operation. Refer to AMETEK Programmable Power website, www.programmablepower.com, to download latest version.

6.3.1 Trigger Mode

Trigger mode could be selected from the front panel using the MODE field in the HARMONICS menu of the MEASUREMENTS screen; refer to Figure 6-4.

The following trigger modes are available in the HARMONICS menu:

- Single (SINGLE)** This mode causes the acquisition system to be armed only once after the initial START. The power source waits until a trigger event occurs, after which data is acquired; when acquisition is completed, the system is put in an idle state. A new START must be given to trigger a new acquisition. This mode is appropriate for capturing events that occur only once such as the inrush current when turning on a load.
- Continuous (CONT)** This mode causes the trigger system to re-arm itself after each trigger event. Every time a new trigger occurs, new data is acquired and the display is updated. No user intervention is required after the initial START. This mode is appropriate for capturing repetitive events or to monitor the source output continuously.

6.3.2 Trigger source

Trigger sources could be selected from the front panel using the SOUR(CE) field in the HARMONICS menu of the MEASUREMENTS screen; refer to Figure 6-4.

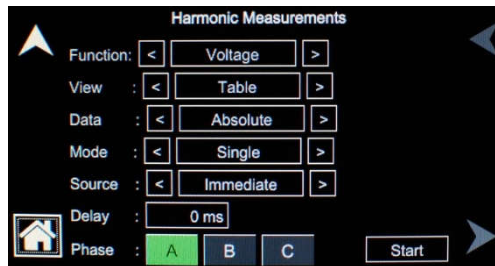

Figure 6-4. HARMONICS Menu, Triggering

The following trigger sources are available in the HARMONICS menu:

Entry	Description
Immediate	This mode causes a trigger to occur as soon as the START field is tapped. No trigger source needs to be specified for this trigger mode. This mode is equivalent to the SCPI command, INIT:IMM:ACQ. This trigger source is appropriate if no trigger condition is known or desired. When using this trigger source, the acquisition is always triggered.

Phase

This mode causes the acquisition system to wait for the zero-phase angle of the output voltage. The phase angle of the current with respect to the voltage is determined by the load, so triggering at a specific current phase angle is not possible, since it is not controlled by the power source. However, when capturing current waveform data, the phase relationship to the voltage can be determined easily by triggering at the 0° point on the voltage.

6.3.3 Trigger delay

The trigger DELAY field allows setting the amount of pre- or post-trigger data that should be used when positioning the data acquisition window with respect to the trigger event.

Entry	Description
POST-TRIGGER DELAY	Positive trigger delay value means the acquisition window is delayed by the amount of time specified. In this case, the actual trigger instant itself is no longer present in the acquisition buffer. This condition is shown in Figure 6-5, where a 20 ms trigger delay is used after triggering on phase = 180° , with an output frequency of 50 Hz. The trigger point is indicated by the dashed line; it occurs on the first 180° point that occurs after the START field is tapped. Once the trigger occurs, the acquisition holds off the specified 20 ms, after which the data is captured. Using a positive trigger delay value always yields post-trigger data. Positive trigger delay values may be set from 0.0 ms to 1000.0 ms (1 second) in 0.1 ms increments. The value may be entered directly with the touch-screen keypad or using the rotary encoder.

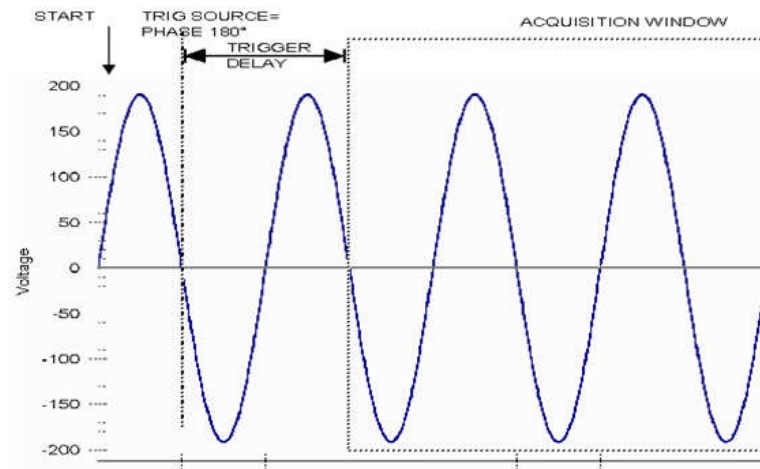

Figure 6-5. Post-Trigger (Positive Delay)

PRE-TRIGGER DELAY

Negative trigger delay value may be specified up to the maximum time depth of the acquisition window. The value may be entered directly with the touch-screen keypad or using the rotary encoder. The following time interval range is available: Negative trigger delay, 42.6 ms to 426 ms. This condition is shown in Figure 6-6 where a 20 ms trigger delay is used after triggering on phase = 0° , with an output frequency of 50 Hz. The trigger point is indicated by the dashed line; it occurs on the first-degree point that occurs after the

START field is tapped. Once the trigger occurs, the acquisition is captured beginning from the specified 20 ms before the trigger point. Using a negative trigger delay value always yields pre-trigger data.

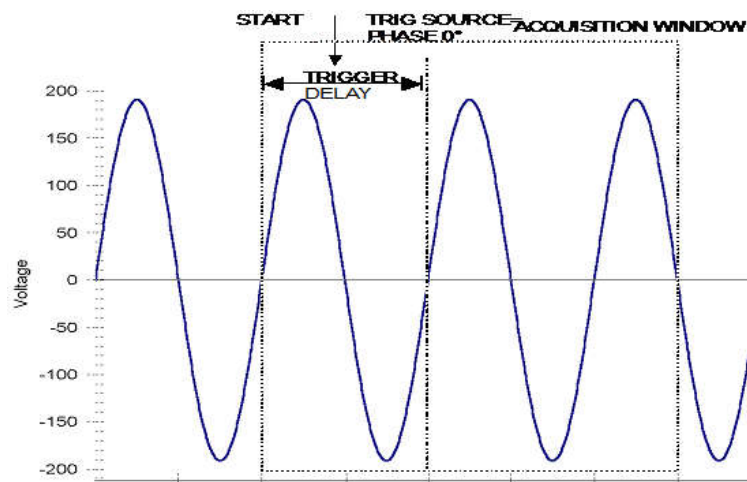

Figure 6-6. Pre-Trigger (Negative Delay)

7. Transient Programming

Transient programming provides a precise timing control over output voltage and frequency changes. This mode of operation can be used to test a product for susceptibility to common AC and DC power conditions such as surges, sags, brownouts and spikes. By combining transient list programming with custom waveforms, a broad range of AC or DC conditions can be simulated on the output of the power source. Refer to Section 4.5.4 for specifics on using the display menus to program the transients from the front panel. The full capability of transients programming could be accessed through the remote digital interface using the Asterion Virtual Panels or SCPI commands. Refer to the Asterion Series Programming Manual P/N M330100-01 (distributed on the CD, CIC496), or refer to the AMETEK Programmable Power website, www.programmablepower.com, to download latest versions.

7.1 Using Transient Modes

Output transients are used to:

- Synchronize output changes with a particular phase of the voltage waveform.
- Synchronize output changes with internal or external signals.
- Simulate surge, sag, and dropout conditions with precise control of duration and phase.
- Create complex, multi-level sequences of output changes.
- Create output changes that have rapid or precise timing requirements.

The following power source functions are subject to transient control:

- AC output voltage
- DC output voltage
- Frequency
- Start phase angle.
- AC and DC voltage slew rate.
- Frequency slew rate

The following transient modes can be generated using the Asterion Virtual Panels or SCPI commands:

Step	Generates a single triggered output change.
Pulse	Generates an output change which returns to its original state after some time period.
List	Generates a sequence of output changes, each with an associated dwell time or paced by triggers.
Fixed	Turns off the transient functions; with SCPI commands, only the IMMEDIATE values are used as the data source for a particular function.

Figure 7-1 shows a representation of programming changes in the transient modes, and the output waveform that is generated in each mode.

When a trigger is received in Step or Pulse modes, the triggered functions are set from their SCPI command, IMMEDIATE, to their TRIGGERED value. In Step mode, the triggered value becomes the immediate value. In Pulse mode, the functions return to their immediate value during the low portion of the pulse. If there are no further pulses, the immediate value remains in effect. In List mode, the functions remain at the last list value at the completion of the list. STEP, PULSE, and LIST modes are not allowed to be mixed among functions.

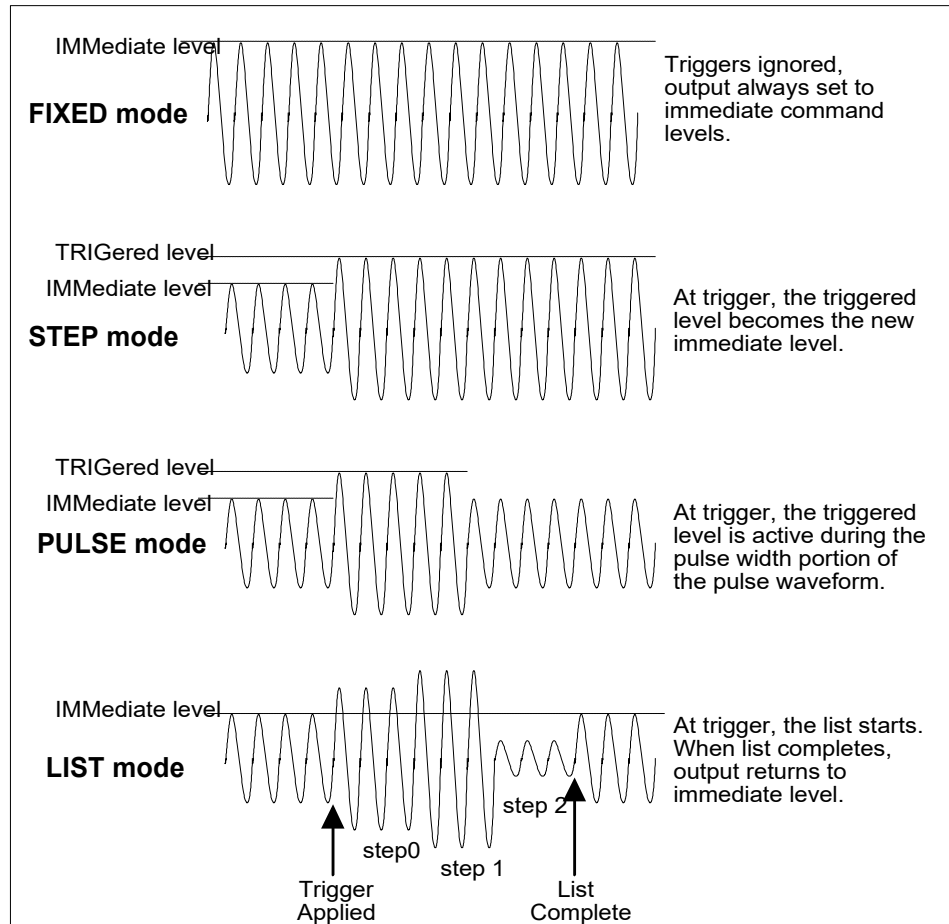

Figure 7-1. Output Transient Modes

7.1.1 Step Transients

Step transients specify an alternate or triggered voltage level that the AC source will apply to the output when it receives a trigger. Because the default transient voltage level is zero volts, a triggered voltage level must be entered before a trigger to the power source could change the output amplitude. Step transients could only be programmed through the remote digital interface using the Asterion Virtual Panels or SCPI commands. Refer to the Asterion Series Programming Manual P/N M330100-01 (distributed on the CD, CIC496), or refer to AMETEK Programmable Power website, www.programmablepower.com, to download latest versions.

7.1.2 Pulse Transients

Pulse transients program the output to a specified value for a predetermined amount of time. At the end of the Pulse transient, the output voltage returns to its previous value. Parameters required to set up a Pulse transient include the pulse count, pulse period, and pulse duty cycle. An example of a Pulse transient is shown in Figure 7-2. In this case, the count is 4, the pulse period is 16.6 ms (for 60 Hz) and the duty cycle is 33%. Pulse transients could only be programmed through the remote digital interface using the Asterion Virtual Panels or SCPI commands. Refer to the Asterion Series Programming Manual P/N M330100-01 (distributed on the CD, CIC496), or refer to the AMETEK Programmable Power website, www.programmablepower.com, to download latest versions.

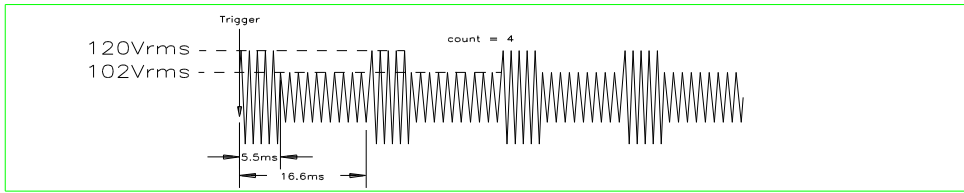

Figure 7-2. Pulse Transients

7.1.3 List Transients

List transients provide the most versatile means of controlling the output in a specific manner as they allow a series of parameters to be programmed in a timed sequence. Figure 7-3 shows a voltage output generated from a list. The output shown represents three different AC voltage steps: 160 volts for 33 milliseconds, 120 volts for 83 ms, and 80 volts for 150 ms, separated by three intervals of zero volts for 67 ms. The list specifies the pulses as three voltage points (point 0, 2, and 4), each with its corresponding dwell points. The intervals are three zero-voltage points (point 1, 3, and 5) of equal time duration. The count parameter causes the list to execute twice when started by a single trigger.

Transient list programming is supported through the front panel with the TRANSIENTS menu in the OUTPUT PROGRAM screen; refer to Figure 4-16 and Figure 4-21. Transient lists can also be programmed through the remote digital interface using the Asterion Virtual Panels or SCPI commands. Refer to the Asterion Series Manual P/N M330100-01 (distributed on the CD, CIC496), or refer to the AMETEK Programmable Power website, www.programmablepower.com, to download latest versions.

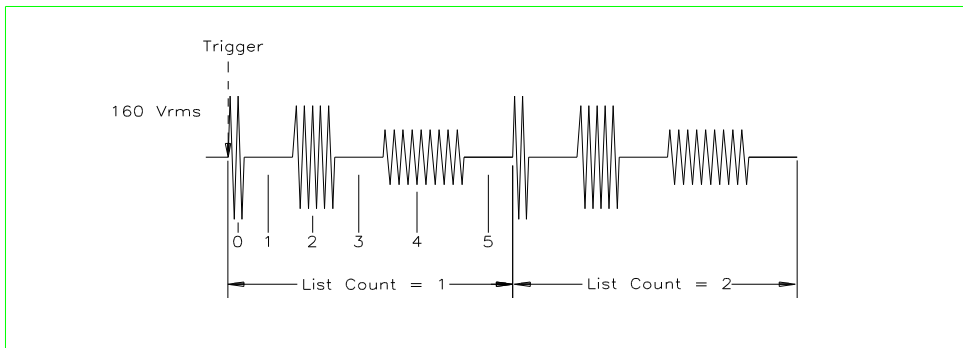

Figure 7-3. List Transients

To set up this type of transient list through the front panel, proceed as follows:

1. Navigate to the SETTINGS menu of the TRANSIENTS screen; refer to Figure 4-22. Set the parameter values as follows:
 - Phase:** A, B, or C
 - Time:** sec
 - Volt(age):** V
 - Freq(ueency):** Hz
 - Trig(ger):** All
 - Step:** All
 - Start Phase A:** Zero

2. Tap on the TRIGGER sub-menu; refer to Figure 4-23. Set the parameter values as follows:
 - Phase Sync:** All
 - Trig Outsource:** BOT
 - Start Source:** Immediate
3. Navigate to the VIEW menu of the TRANSIENTS screen; refer to Figure 4-24 and Figure 4-25.
4. Tap the ADD field to enter the ADD sub-menu; refer to Figure 4-26.
5. Tap the VOLTAGE SURGE/SAG selection button. Enter the following parameter values:
 - T(ime):** 0.083 sec; the value is entered as seconds, with a minimum time resolution of 0.001 sec;
 - V(olts):** 160 V; the surge voltage value;
 - To V(olts):** 0 V; the voltage value following the surge;
 - Repeat:** 0; number of times to repeat this transient event (not the entire transient list, as described in Step 10, below);
 - Function:** Sine; output waveform
 - Trig:** blank (no selection); not used in this example
 - Delay:** 0.067 sec; time interval to remain at to V(olts) level.
6. Tap the SAVE field in the VOLTAGE SURGE/SAG sub-menu.
7. Repeat Steps 4 through 7 two more times using 120 V / 83 ms and 80 V / 150 ms as values.
8. Once the three events are programmed, navigate to the VIEW menu of the TRANSIENTS screen to view all available events in the transient list. If more events are programmed then they could fit in the window, the arrow buttons on the right-side could be used to scroll through the list. To edit an existing event, move the selection field to the relevant event number and click the encoder switch to select it. Use the edit fields edit or delete the event or add events before or after the selected one.
9. Navigate to the RUN menu of the TRANSIENTS screen; refer to Figure 4-21.
10. Tap the X Times selection button and enter 1 in the X Times field. This will cause the transient program to repeat once and thus run two times total. Do not confuse this global list level repeat capability with the list event level repeat field mentioned in Step 5.
11. Tap the START field in the RUN menu of the TRANSIENTS screen. The transients list will be executed two times, as shown in Figure 7-3. The power source will remain at the last programmed value of the list (zero volts in this example).

7.2 Programming Slew Rates

As shown in the previous examples there are a number of ways that custom waveforms could be generated. Programmable slew rates provide additional flexibility when customizing waveforms. Slew rates determine how fast the voltage or frequency is changed by the controller when a step, pulse, or list transient is triggered. Slew rates cannot be programmed from the front panel and are always set to their maximum values at power-on. To use programmable slew rates, the power source must be programmed through the remote digital interface using the Asterion Virtual Panels or SCPI commands, refer to the Asterion Series Programming Manual P/N M330100-01 (distributed on the CD, CIC496), or refer to AMETEK Programmable Power website, www.programmablepower.com, to download latest versions.

7.3 Switching Waveforms in Transient Lists

The FUNCTION field available in each transient list event setup menu may be used to dynamically switch waveforms during transient execution. This allows different waveforms to be used during transient execution. Waveforms may be switched without the output of the source being turned off.

Figure 7-4 illustrates the concept of using different waveforms at different steps in a transient list. In this case, the change was scheduled to occur at the zero crossing. Any phase angle can be used to start a transient step, however.

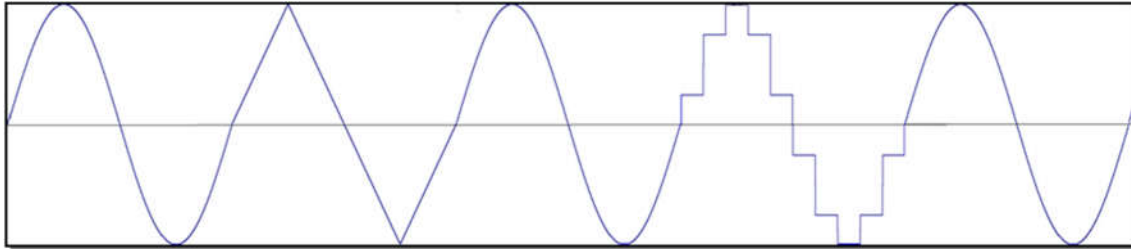

Figure 7-4. Switching Waveforms in a Transient List Transient Execution

A transient list can be executed from the RUN menu of the Transients screen; refer to Figure 4-21. Tapping on the RUN selection-field will open the RUN menu; refer to Figure 7-5. A selection could be made whether to run the transient list repetitively (Continuous button) or multiple times (X Times button). To start a transient list, tap on the START field. The list will begin to run, and a new selection-field will open, ABORT. A long duration transient could be stopped and aborted by tapping on the ABORT field while a transient execution is in progress. For a short duration transient, this will likely not be visible, as the transient will complete before the screen is updated.

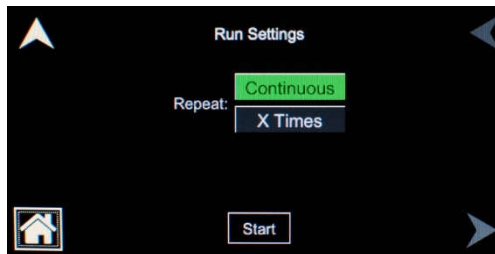

Figure 7-5. RUN Menu: Start and Abort Fields

7.4 Saving Transient List Programs

When the power source is turned off, the transient list that was programmed is not automatically saved. Therefore, the programmed transient list would be lost if the unit is turned off. However, transient programs could be saved in nonvolatile memory for later recall. This allows multiple transient list programs to be recalled quickly without the need to enter all parameters each time. Transient lists are stored as part of the overall power source operational configuration state in any of the available profile state registers; refer to the CONFIGURATION screen in Section 4.5.5. To save a transient list, proceed as follows:

1. After setting up a transient list, run it so that it is transferred to main memory.
2. Tap on the PROFILES field in the CONFIGURATION menu; refer to Figure 4-36.
3. Tap on one of the fifteen PROFILE_x buttons (x = 0 to 14) to select it; refer to Figure 7-6.
4. Tap on the NAME field to open the NAME sub-menu to assign a unique name to the profile. Otherwise, tap on the SAVE field to save the configuration state of the power source to a profile memory register.
5. The profile could be recalled at a later time by selecting the appropriate selection-button and tapping on the LOAD field.

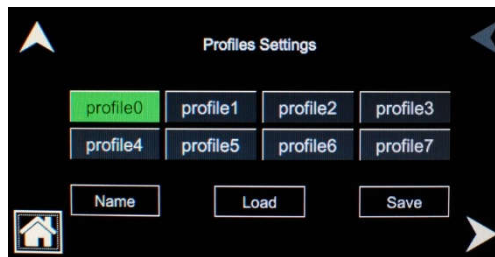

Figure 7-6. CONFIGURATION Menu, PROFILES Selection

8. Calibration

This section presents procedures required to calibrate the Asterion Series power source. It is recommended that calibration should be performed at 12-month intervals, or following service if subassemblies are replaced. The procedures are performed using SCPI commands through the remote digital interface using either the Asterion Virtual Panels program, or a communications program such as HyperTerminal. For details pertaining to operation through the remote digital interface, refer to the Asterion Series Programming Manual P/N M330100-01 (distributed on the CD, CIC496), or refer to the AMETEK Programmable Power website, www.programmablepower.com, to download latest version.

8.1 Calibration Equipment

Table 8-1 presents the equipment required to conduct the calibration.

Equipment	Model
Power Analyzer	Tektronix, Model PA4000, or equivalent
Digital Phase Meter	Krohn-Hite, Model 6620, or equivalent
DVM	Fluke, 8508A, or equivalent
Function Generator	Keysight, Model 33210A, or equivalent
Differential Probe	Tektronix, Model P5202A, or equivalent
Load Bank	Resistive loads resistors at power levels per model rating
Computer Controller	Remote communications program through LAN, USB, or RS-232C

Table 8-1. Calibration Equipment

8.2 Calibration Procedures

8.2.1 Preparation for Calibration



WARNING!

Hazardous voltages exist at the rear of the power source. Care must be taken to avoid contact with the AC input and AC/DC output terminals. Only authorized personnel should perform these procedures.

Only technically trained personnel, who understand the operation of the power source, and are capable of taking accurate readings and follow the procedure steps, should perform calibration. The calibration procedures require precision instrumentation to measure voltage and current; when substituting for the recommended test equipment, ensure that the accuracy is adequate so that excessive error is not incurred, compared to the specifications of the parameters that are to be calibrated. To set up for the alignment procedures, perform the following initial steps:

1. Disconnect AC mains power when making setup connections.
2. Connect the test equipment and loads to the output and control inputs of the power source.
3. Connecting remote sense leads and enables the remote sense in the power source. To preclude error from line voltage, drop, ensure that the digital voltmeter that measures output voltage is connected at the same point where the sense leads are connected.

4. Allow a 30-minute warm-up period for the power source and test equipment before conducting the calibration procedure.
- 5.

**CAUTION!**

The AC input power must be cycled off then on when calibration has been completed to terminate the alignment routines and have calibration take effect. This is necessary also if only subsections of the calibration procedure are performed.

8.2.2 Output Voltage AC Zero Alignment, AC-Mode

1. Cycle the AC input power to the unit off then on.
With the external DVM set for AC, monitor the voltage at the power source output.
3. Ensure that there is no load connected to the output of the power source.
4. Enter the calibration password with the SCPI command, CAL:PASS "5000".
5. Send the following SCPI command to select Phase-A:
INST:SEL A
6. Send following SCPI commands to the power source; the ALC could be either on or off (400 VAC range selected):
VOLT:RANGE 400
MODE AC
FREQ 400
VOLT 0
OUTP 1
7. Perform the AC zero alignment using the SCPI command, CAL:VOLT:LRAN:ZERO <numeric value>. The numeric value is in the range of 0 to 255; the default value is 127. Align for the lowest AC output voltage reading of the selected phase, but at least < 200 mV. Ensure that the DVM is at a high enough range (e.g. 10 or 20 VAC) so that errors are not introduced from output ripple/noise components.
8. Send the SCPI command, INST:SEL B, and repeat Step-6 and Step-7 to align Phase-B.
9. Send the SCPI command, INST:SEL C, and repeat Step-6 and Step-7 to align Phase-C.

8.2.3 Output Voltage DC Zero Alignment, DC-Mode

1. With the external DVM set for DC, monitor the voltage at the power source output.
2. Ensure that there is no load connected to the output of the power source.
3. Enter the calibration password with the SCPI command, CAL:PASS "5000".
4. Send the following SCPI command to select Phase-A:
INST:SEL A.
5. Send the following SCPI commands to the power source (500 VDC range selected; ALC off):
VOLT:ALC OFF
MODE DC
VOLT:RANGE 500
VOLT 0
OUTP 1
6. Perform the alignment with the SCPI command, CAL:VOLT:DC:ZERO <numeric value>. Start with a value of zero and increase or decrease for the lowest DC output voltage reading of the selected phase within the range of 0 ± 5 mV DC. The maximum range of this alignment is ± 2000 .
7. Send the SCPI command, INST:SEL B, and repeat Step-5 and Step-6 to align Phase-B.
8. Send the SCPI command, INST:SEL C, and repeat Step-5 and Step-6 to align Phase-C.

8.2.4 Output Voltage Gain Initial Alignment, AC-Mode and DC-Mode

1. With the external DVM set for AC, monitor the voltage at the power source output.
2. Ensure that there is no load connected to the output of the power source.
3. Enter the calibration password with the SCPI command, CAL:PASS "5000".
4. Send the following SCPI command to select Phase-A:
INST:SEL A
5. Voltage Gain Initial Alignment, AC-Mode: Send the following SCPI commands to the power source (400 VAC range selected; ALC off):
VOLT:ALC OFF
MODE AC
VOLT:RANGE 400
VOLT 350
FREQ 400
OUTP 1
6. Send in the SCPI command, CAL:VOLT:FSC 15000.
7. Perform the alignment by adjusting the output AC voltage of the selected phase to 350 V(RMS), ± 1 V as indicated on the external DVM by using the SCPI command, CAL:VOLT:FSC <numeric value> to increase or decrease the value. Align for the closest reading to 350V(RMS).
8. Send the SCPI command, INST:SEL B, and repeat Step-6 and Step-7 to align Phase-B.
9. Send the SCPI command, INST:SEL C, and repeat Step-6 and Step-7 to align Phase-C.
10. Voltage Gain Initial Alignment, DC-Mode:
11. Send the following SCPI command to select Phase-A:
INST:SEL A
12. Send the following commands, which also change the voltage mode to DC:
OUTP OFF
MODE DC
VOLT 450
OUTP 1
13. Send in the SCPI command, CAL:VOLT:DC 13000.
14. Perform the alignment by adjusting the output DC voltage of the selected phase to 450 VDC, ± 1 V as indicated on the external DVM by using the SCPI command, CAL:VOLT:FSC <numeric value> to increase or decrease the value. Align for the closest reading to 450 VDC.
15. Send the SCPI command, INST:SEL B, and repeat Step-12 through Step-14 to align Phase-B.
16. Send the SCPI command, INST:SEL C, and repeat Step-12 through Step-14 to align Phase-C.

8.2.5 Output Voltage Measurement AC Gain Alignment, AC-Mode

- With the external DVM set for AC, monitor the voltage at the power source output.
2. Ensure that there is no load connected to the output of the power source.
 3. Enter the calibration password with the SCPI command, CAL:PASS "5000".
 4. Send the following SCPI command to select Phase-A:
INST:SEL A
 5. Send the following SCPI commands to the power source (400 VAC range selected; ALC off):
VOLT:ALC OFF
MODE AC
VOLT:RANG 400
VOLT 350
FREQ 100
OUTP 1
 6. Perform the alignment with the SCPI command, CAL:MEAS:VOLT <numeric value>. The numeric value for the selected phase is the actual output reading from the external DVM connected to the power source output.
 7. Send the SCPI query command, *OPC?, to determine when this alignment section has been completed. Ensure alignment has completed (query returns a 1) before continuing.
 8. Send the SCPI command, INST:SEL B, and repeat Step-5 through Step-7 to align Phase-B.
 9. Send the SCPI command, INST:SEL C, and repeat Step-5 through Step-7 to align Phase-C.

8.2.6 Output Voltage Measurement DC-Positive Gain Alignment, DC-Mode

- With the external DVM set for DC, monitor the voltage at the power source output.
2. Ensure that there is no load connected to the output of the power source.
 3. Enter the calibration password with the SCPI command, CAL:PASS "5000".
 4. Send the following SCPI command to select Phase-A:
INST:SEL A
 5. Send the following SCPI commands to the power source (500 VDC selected; ALC off):
OUTP 0
VOLT:ALC OFF
MODE DC
VOLT:RANG 500
VOLT 450
OUTP 1
 6. Perform the alignment with the command CAL:MEAS:VOLT:DC <numeric value>. The numeric value for the selected phase is the actual output reading from the external DVM connected to the power source output.
 7. Send the SCPI query command, *OPC?, to determine when this alignment section has been completed. Ensure alignment has completed (query returns a 1) before continuing.
 8. Send the SCPI command, INST:SEL B, and repeat Step-5 through Step-7 to align Phase-B.
 9. Send the SCPI command, INST:SEL C, and repeat Step-5 through Step-7 to align Phase-C.

8.2.7 Output Voltage Measurement DC-Negative Gain Alignment, DC-Mode

- With the external DVM set for DC, monitor the voltage at the power source output.
2. Ensure that there is no load connected to the output of the power source.
 3. Enter the calibration password with the SCPI command, CAL:PASS "5000".
 4. Send the following SCPI command to select Phase-A:
INST:SEL A
 5. Send the following SCPI commands to the power source (500 VDC selected; ALC off):
OUTP 0
VOLT:ALC OFF
MODE DC
VOLT:RANG 500
VOLT -450
OUTP 1
 6. Perform the alignment with the command CAL:MEAS:VOLT:DC:NEG <numeric value>. The numeric value for the selected phase is the actual output reading from the external DVM connected to the power source output.
 7. Send the SCPI query command, *OPC?, to determine when this alignment section has been completed. Ensure alignment has completed (query returns a 1) before continuing.
 8. Send the SCPI command, INST:SEL B, and repeat Step-5 through Step-7 to align Phase-B.
 9. Send the SCPI command, INST:SEL C, and repeat Step-5 through Step-7 to align Phase-C.

8.2.8 Output Current Measurement AC Low-Range Gain Alignment, AC-Mode

- Connect the power analyzer to AC current measurement.
2. Connect the load to the output of power source.
 3. Set load to the low-range resistance value shown in Table 8-2, as appropriate for the particular Asterion Series model that is to be aligned. Ensure that the load setting maintains the power source in constant-voltage (CV) mode of operation.
 4. Enter the calibration password with the SCPI command, CAL:PASS "5000".
 5. Send the following SCPI command to select Phase-A:
INST:SEL A
 6. Set the output current of the power source to the low-range value shown in Table 8-2, as appropriate for the particular Asterion Series model that is to be aligned, using the SCPI command, CURR <numeric value>.
 7. Send the following SCPI commands to the power source (200 VAC range selected; ALC off):
OUTP 0
CURR:PROT OFF
MODE AC
VOLT:RANGE 200
VOLT 100
FREQ 100
VOLT:ALC OFF
OUTP 1
 8. Perform the alignment with the SCPI command, CAL:MEAS:CURR <numeric value>. The numeric value for the selected phase is the actual output current derived from the reading of the external power analyzer. Ensure that the temperature coefficient of the load is low so that the resistance value of the load does not change during the time interval required to read and enter the external reading.
 9. Send the SCPI query command, *OPC?, to determine when this alignment section has been completed. Ensure alignment has completed (query returns a 1) before continuing.
 10. Repeat Steps 5 through 8 for output frequencies of 1200 Hz, 3000 Hz, and 5000 Hz, or the highest frequency of the particular power source model being aligned. The SCPI command, FREQ, must be changed for each frequency, e.g. FREQ 1200, FREQ 3000, FREQ 5000.
 11. Send the SCPI command, INST:SEL B, and repeat Step-6 through Step-10 to align Phase-B.

12. Send the SCPI command, `INST:SEL C`, and repeat Step-6 through Step-10 to align Phase-C.
13. The calibration coefficients could be queried using the SCPI command, `CAL:MEAS:CURRE? ALL`. The command will return a command-separated number sequence of four calibration sets. Each set will have the calibration frequency and the corresponding coefficient for low-range and high range, with the following format:
`f1,dataL1,dataH1,f2,dataL2,dataH2,f3,dataL3,dataH3,f4,dataL4,dataH4`.

8.2.9 Output Current Measurement AC High-Range Gain Alignment, AC-Mode

Connect the power analyzer to AC current measurement.

2. Connect the load to the output of power source.
3. Set load to the high-range resistance value shown in Table 8-2, as appropriate for the particular Asterion Series model that is to be aligned. Ensure that the load setting maintains the power source in constant-voltage (CV) mode of operation.
4. Enter the calibration password with the SCPI command, `CAL:PASS "5000"`.
5. Send the following SCPI command to select Phase-A:
`INST:SEL A`
6. Set the output current of the power source to the high-range value shown in Table 8-2, as appropriate for the particular Asterion Series model that is to be aligned, using the SCPI command, `CURR <numeric value>`.
7. Send the following SCPI commands to the power source (400 VAC range selected; ALC off):
`OUTP 0`
`CURR:PROT OFF`
`MODE AC`
`VOLT:RANGE 400`
`VOLT 200`
`FREQ 100`
`VOLT:ALC OFF`
`OUTP 1`
8. Perform the alignment with the SCPI command, `CAL:MEAS:CURRE <numeric value>`. The numeric value for the selected phase is the actual output current derived from the reading of the external power analyzer. Ensure that the temperature coefficient of the load is low so that the resistance value of the load does not change during the time interval required to read and enter the external reading.
9. Send the SCPI query command, `*OPC?`, to determine when this alignment section has been completed. Ensure alignment has completed (query returns a 1) before continuing.
10. Repeat Steps 5 through 8 for output frequencies of 1200 Hz, 3000 Hz, and 5000 Hz, or the highest frequency of the particular power source model being aligned. The SCPI command, `FREQ`, must be changed for each frequency, e.g. `FREQ 1200`, `FREQ 3000`, `FREQ 5000`.
11. Send the SCPI command, `INST:SEL B`, and repeat Step-6 through Step-10 to align Phase-B.
12. Send the SCPI command, `INST:SEL C`, and repeat Step-6 through Step-10 to align Phase-C.
13. The calibration coefficients could be queried using the SCPI command, `CAL:MEAS:CURRE? ALL`. The command will return a command-separated number sequence of four calibration sets. Each set will have the calibration frequency and the corresponding coefficient for low-range and high range, with the following format:
`f1,dataL1,dataH1,f2,dataL2,dataH2,f3,dataL3,dataH3,f4,dataL4,dataH4`.

8.2.10 Output Current Measurement AC Low-Range Offset Alignment, AC-Mode

- Ensure that there is no load connected to the output of the power source.
2. Enter the calibration password with the SCPI command, CAL:PASS "5000".
 3. Send the following SCPI command to select Phase-A:
INST:SEL A
 4. Send the following SCPI commands to the power source (200 VAC range selected; ALC off):
OUTP 0
CURR:PROT OFF
MODE AC
VOLT:RANGE 200
VOLT 0
FREQ 100
VOLT:ALC OFF
OUTP 1
 5. Reset the low-range offset alignment with the SCPI command, CAL:MEAS:CURR:LROF 0.
 6. Measure the output current with the SCPI command, MEAS:CURR?.
 7. Perform the alignment with the SCPI command, CAL:MEAS:CURR:LROF <numeric value>. The numeric value is the output current returned by the command MEAS:CURR?. Enter successive values from MEAS:CURR? until the alignment gives a value of ≤ 1 mA(RMS).
 8. Send the SCPI query command, *OPC?, after each numeric value entry to determine when this alignment has been completed. Ensure alignment has completed (query returns a 1) before continuing.
 9. Send the SCPI command, INST:SEL B, and repeat Step-4 through Step-8 to align Phase-B.
 10. Send the SCPI command, INST:SEL C, and repeat Step-4 through Step-8 to align Phase-C.

8.2.11 Output Current Measurement AC High-Range Offset Alignment, AC-Mode

- Ensure that there is no load connected to the output of the power source.
2. Enter the calibration password with the SCPI command, CAL:PASS "5000".
 3. Send the following SCPI command to select Phase-A:
INST:SEL A
 4. Send the following SCPI commands to the power source (400 VAC range selected; ALC off):
OUTP 0
CURR:PROT OFF
MODE AC
VOLT:RANGE 400
VOLT 0
FREQ 100
VOLT:ALC OFF
OUTP 1
 5. Reset the high-range offset alignment with the SCPI command, CAL:MEAS:CURR:HROF 0.
 6. Measure the output current with the SCPI command, MEAS:CURR?.
 7. Perform the alignment with the SCPI command, CAL:MEAS:CURR:HROF <numeric value>. The numeric value is the output current returned by the command MEAS:CURR?. Enter successive values from MEAS:CURR? until the alignment gives a value of ≤ 1 mA(RMS).
 8. Send the SCPI query command, *OPC?, after each numeric value entry to determine when this alignment has been completed. Ensure alignment has completed (query returns a 1) before continuing.
 9. Send the SCPI command, INST:SEL B, and repeat Step-4 through Step-8 to align Phase-B.
 10. Send the SCPI command, INST:SEL C, and repeat Step-4 through Step-8 to align Phase-C.

8.2.12 Output Current Measurement DC-Positive Low-Range Gain Alignment, DC-Mode

1. Connect the power analyzer to DC current measurement.
2. Connect the load to the output of power source.
3. Set load for the low-range resistance value shown in Table 8-3, as appropriate for the particular Asterion Series model that is to be aligned. Ensure that the load setting maintains the power source in constant-voltage (CV) mode of operation.
4. Enter the calibration password with the SCPI command, CAL:PASS "5000".
5. Send the following SCPI command to select Phase-A:
INST:SEL A
6. Set the output current of the power source to the low-range value shown in Table 8-2, as appropriate for the particular Asterion Series model that is to be aligned, using the SCPI command, CURR <numeric value>.
7. Send the following SCPI commands to the power source (250 VDC range selected; ALC off):
OUTP 0
CURR:PROT OFF
MODE DC
VOLT:RANGE 250
VOLT 125
VOLT:ALC OFF
OUTP 1
8. Perform the alignment with the SCPI command, CAL:MEAS:CURR:DC <numeric value>. The numeric value for the selected phase is the actual output current derived from the reading of the external power analyzer.
9. Send the SCPI query command, *OPC?, to determine when this alignment section has been completed. Ensure alignment has completed (query returns a 1) before continuing.
10. Send the SCPI command, INST:SEL B, and repeat Step-6 through Step-9 to align Phase-B.
11. Send the SCPI command, INST:SEL C, and repeat Step-6 through Step-9 to align Phase-C.
12. The DC-positive calibration coefficients could be queried using the SCPI command, CAL:MEAS:CURR:DC?; the command will return a comma-separated number sequence, with the low-range coefficient followed by the high-range coefficient.

8.2.13 Output Current Measurement DC-Positive High-Range Gain Alignment, DC-Mode

1. Connect the power analyzer to DC current measurement.
2. Connect the load to the output of power source.
3. Set load for the high-range resistance value shown in Table 8-3, as appropriate for the particular Asterion Series model that is to be aligned.
4. Enter the calibration password with the SCPI command, CAL:PASS "5000".
5. Send the following SCPI command to select Phase-A:
INST:SEL A
6. Set the output current of the power source to the high-range value shown in Table 8-3, as appropriate for the particular Asterion Series model that is to be aligned, using the SCPI command, CURR <numeric value>.
7. Send the following SCPI commands to the power source (500 VDC range selected; ALC off):
OUTP 0
CURR:PROT OFF
MODE DC
VOLT:RANGE 500
VOLT 250
VOLT:ALC OFF
OUTP 1
8. Perform the alignment with the SCPI command, CAL:MEAS:CURR:DC <numeric value>. The numeric value for the selected phase is the actual output current derived from the reading of the external power analyzer.

9. Send the SCPI query command, *OPC?, to determine when this alignment section has been completed. Ensure alignment has completed (query returns a 1) before continuing.
10. Send the SCPI command, INST:SEL B, and repeat Step-6 through Step-9 to align Phase-B.
11. Send the SCPI command, INST:SEL C, and repeat Step-6 through Step-9 to align Phase-C.
12. The DC-positive calibration coefficients could be queried using the SCPI command, CAL:MEAS:CURR:DC?; the command will return a comma-separated number sequence, with the low-range coefficient followed by the high-range coefficient.

8.2.14 Output Current Measurement DC-Negative Low-Range Gain Alignment, DC-Mode

Connect the power analyzer to DC current measurement.

2. Connect the load to the output of power source.
3. Set load for the low-range resistance value shown in Table 8-3, as appropriate for the particular Asterion Series model that is to be aligned.
4. Enter the calibration password with the SCPI command, CAL:PASS "5000".
5. Send the following SCPI command to select Phase-A:
INST:SEL A
6. Set the output current of the power source to the low-range value shown in Table 8-3, as appropriate for the particular Asterion Series model that is to be aligned, using the SCPI command, CURR <numeric value>.
7. Send the following SCPI commands to the power source (250 VDC range selected; ALC off):
OUTP 0
CURR:PROT OFF
MODE DC
VOLT:RANGE 250
VOLT -100
VOLT:ALC OFF
OUTP 1
8. Perform the alignment with the SCPI command, CAL:MEAS:CURR:DC <numeric value>. The numeric value for the selected phase is the actual output current derived from the reading of the external power analyzer.
9. Send the SCPI query command, *OPC?, to determine when this alignment section has been completed. Ensure alignment has completed (query returns a 1) before continuing.
10. Send the SCPI command, INST:SEL B, and repeat Step-6 through Step-9 to align Phase-B.
11. Send the SCPI command, INST:SEL C, and repeat Step-6 through Step-9 to align Phase-C.
12. The DC-negative calibration coefficients could be queried using the SCPI command, CAL:MEAS:CURR:DC:NEG?, as the comma-separated, low-range coefficient followed by the high-range coefficient

8.2.15 Output Current Measurement DC-Negative High-Range Gain Alignment, DC-Mode

Connect the power analyzer to DC current measurement.

2. Connect the load to the output of power source.
3. Set load for the high-range resistance value shown in Table 8-3, as appropriate for the particular Asterion Series model that is to be aligned.
4. Enter the calibration password with the SCPI command, CAL:PASS "5000".
5. Send the following SCPI command to select Phase-A:
INST:SEL A
6. Set the output current of the power source to the high-range value shown in Table 8-3, as appropriate for the particular Asterion Series model that is to be aligned, using the SCPI command, CURR <numeric value>.

7. Send the following SCPI commands to the power source (500 VDC range selected; ALC off):
 - OUTP 0
 - CURR:PROT OFF
 - MODE DC
 - VOLT:RANGE 500
 - VOLT -250
 - VOLT:ALC OFF
 - OUTP 1
8. Perform the alignment with the SCPI command, CAL:MEAS:CURR:DC <numeric value>. The numeric value for the selected phase is the actual output current derived from the reading of the external power analyzer.
9. Send the SCPI query command, *OPC?, to determine when this alignment section has been completed. Ensure alignment has completed (query returns a 1) before continuing.
10. Send the SCPI command, INST:SEL B, and repeat Step-6 through Step-9 to align Phase-B.
11. Send the SCPI command, INST:SEL C, and repeat Step-6 through Step-9 to align Phase-C.
12. The DC-negative calibration coefficients could be queried using the SCPI command, CAL:MEAS:CURR:DC:NEG? ?; the command will return a comma-separated number sequence, with the low-range coefficient followed by the high-range coefficient.

8.2.16 Output Current Measurement Low-Range Offset Alignment, DC-Mode

Ensure that there is no load connected to the output of the power source.

2. Enter the calibration password with the SCPI command, CAL:PASS "5000".
3. Send the following SCPI command to select Phase-A:
 - INST:SEL A
4. Send the following SCPI commands to the power source (250 VDC range selected; ALC off):
 - OUTP 0
 - CURR:PROT OFF
 - MODE DC
 - VOLT:RANGE 250
 - VOLT 0
 - VOLT:ALC OFF
 - OUTP 1
5. Reset low-range offset alignment with the SCPI command, CAL:MEAS:CURR:DC:LROF 0.
6. Measure the output current with the SCPI command, MEAS:CURR:DC?.
7. Perform the alignment with the SCPI command, CAL:MEAS:CURR:DC:LROF <numeric value>. The numeric value is the output current returned by the command MEAS:CURR:DC?. Enter successive values from MEAS:CURR:DC? until the alignment gives a value of ≤ 1 mA(DC).
8. Send the SCPI query command, *OPC?, after each numeric value entry to determine when this alignment has been completed. Ensure alignment has completed (query returns a 1) before continuing.
9. Send the SCPI command, INST:SEL B, and repeat Step-4 through Step-8 to align Phase-B.
10. Send the SCPI command, INST:SEL C, and repeat Step-4 through Step-8 to align Phase-C.

8.2.17 Output Current Measurement High-Range Offset Alignment, DC-Mode

- Ensure that there is no load connected to the output of the power source.
2. Enter the calibration password with the SCPI command, CAL:PASS "5000".
 3. Send the following SCPI command to select Phase-A:
INST:SEL A
 4. Send the following SCPI commands to the power source (500 VDC range selected; ALC off):
OUTP 0
CURR:PROT OFF
MODE DC
VOLT:RANGE 500
VOLT 0
VOLT:ALC OFF
OUTP 1
 5. Reset high-range offset alignment with the SCPI command, CAL:MEAS:CURR:DC:HROF 0.
 6. Measure the output current with the SCPI command, MEAS:CURR:DC?.
 7. Perform the alignment with the SCPI command, CAL:MEAS:CURR:DC:HROF <numeric value>. The numeric value is the output current returned by the command MEAS:CURR:DC?. Enter successive values from MEAS:CURR? until the alignment gives a value of ≤ 1 mA(DC).
 8. Send the SCPI query command, *OPC?, after each numeric value entry to determine when this alignment has been completed. Ensure alignment has completed (query returns a 1) before continuing.
 9. Send the SCPI command, INST:SEL B, and repeat Step-4 through Step-8 to align Phase-B.
 10. Send the SCPI command, INST:SEL C, and repeat Step-4 through Step-8 to align Phase-C.

Asterion Model	Load Value, Low-Range, Ω	Current Setpoint, AC Low-Range, A	Load Value, High-Range, Ω	Current Setpoint, AC High Range, A
AST 1503	25.00	4.0	100.00	2.0
AST 2253	16.67	6.0	66.67	3.0
AST 3001	4.17	24.0	8.33	12.0
AST 3003	12.5	8.0	50.00	4.0

Table 8-2. Load Values for Output AC Current Alignment

Asterion Model	Load Value, Low-Range, Ω	Current Setpoint, DC Low-Range, A	Load Value, High-Range, Ω	Current Setpoint, DC High Range, A
AST 1503	39.06	3.2	156.24	1.6
AST 2253	26.04	4.8	104.16	2.4
AST 3001	6.51	19.2	26.04	9.6
AST 3003	19.53	6.4	78.13	3.2

Table 8-3. Load Values for Output DC Current Alignment

8.2.18 Output Phase-A Alignment, Output Relative to External SYNC

Connect a function generator to External Input/Output Control connector Pin-10 (SYNC_HIGH) and Pin-11 (SYNC_LOW); refer to Section 3.12.1. Set the function generator to produce a pulse train with an output frequency of 16 Hz and an amplitude switching between 0 V and 5 V.

2. Set up the phase meter to make phase measurements of the power supply output relative to the External SYNC signal as a reference. Connect one input of the phase meter to the function generator output. Using a differential voltage probe for isolation, connect the other input of the phase meter to the power source output of Phase-A.
3. Enter the calibration password with the SCPI command, CAL:PASS "5000".
4. Send the following SCPI commands to the power source (200 VAC range selected):

```

      OUTP 0
      VOLT:SENSE EXT
      VOLT:RANGE 200
      VOLT 100
      FREQ:MODE SENSE
      PHASE 0
      OUTP 1
      
```
5. Perform the alignment with the SCPI command, CAL:PHASE <numeric value>, where the numeric value is derived from phase measurement using the phase meter. Initially set the phase to zero with the SCPI command, CAL:PHASE 0. Record the phase angle reading from the phase meter and then enter a numeric value of opposite polarity to the reading from the phase meter: e.g., if reading is +5°, enter -5°. Iteratively enter numeric values to produce the lowest phase reading. The phase might have to be incremented in steps of 0.2° to account for the phase resolution. Align for the lowest phase reading of < 0.5°.
6. Repeat Step 4 and 5 for output frequencies of 50 Hz, 100 Hz, 500 Hz, 1200 Hz, and 5000 Hz (with SCPI command, FREQ <n>), or the highest frequency of the particular power source model being aligned.
7. The calibration coefficients could be verified with the SCPI query, CAL:PHASE?. First cycle the AC input power off then on, and then send the command, CAL:PHASE?. The command will return a command-separated number sequence of calibration coefficients with the following format: f1,data1,f2,data2,f3,data3,f4,data4,f5,data5,f6,data6,current-cal.

8.2.19 Output Phase-A Alignment, Auxiliary Unit Relative to Master Unit (LKS Option Only)

Connect two power sources in a Master/Auxiliary configuration for multi-phase group. Refer to Section 3.13.1.

2. Connect the remote voltage sense leads of the Master unit and the Auxiliary unit to their respective output terminals.
3. Set up the phase meter to make phase measurements of the Auxiliary power supply output of Phase-A relative to the Master power supply output of Phase-A as a reference. Using differential voltage probes for isolation, connect one input of the phase meter to the Master unit and the other input of the phase meter to the Auxiliary unit.
4. Send the following SCPI commands to the power sources (200 VAC range selected):

To the Auxiliary unit:

```

      OUTP 0
      VOLT:SENSE EXT
      VOLT:RANGE 200
      VOLT 100
      FREQ:MODE EXT
      PHASE 0
      OUTP 1
      
```

To the Master unit:

```

OUTP 0
VOLT:SENSE EXT
VOLT:RANGE 200
VOLT 100
FREQ 16
OUTP 1

```

5. To the Auxiliary unit, enter the calibration password with the SCPI command, CAL:PASS "5000".
6. Perform the alignment with the SCPI command, CAL:PHASE <numeric value>, where the numeric value is derived from phase measurement using the phase meter. Initially, set the phase to zero with the SCPI command, CAL:PHASE 0. Record the phase angle reading from the phase meter and then enter a numeric value of opposite polarity to the reading from the phase meter: e.g., if reading is +5°, enter -5°. Iteratively enter numeric values to produce the lowest phase reading. The phase might have to be incremented in steps of 0.2° to account for the phase resolution. Align for the lowest phase reading of < 0.5°.
7. Repeat Step-4 through Step-6 for output frequencies in the Master unit of 50 Hz, 100 Hz, 500 Hz, 1200 Hz, and 5000 Hz (with SCPI command, FREQ <n>), or the highest frequency of the particular power source model being aligned.
8. The calibration coefficients could be verified with the SCPI query, CAL:PHASE?. First cycle the AC input power off then on, and then send the command, CAL:PHASE?. The command will return a command-separated number sequence of calibration coefficients with the following format: f1,data1,f2,data2,f3,data3,f4,data4,f5,data5,f6,data6,current-cal.

8.2.20 Output Phase-B and Phase-C Alignment Relative to Phase-A

Set up the phase meter to make phase measurements of the power supply output of Phase-B relative to the power supply output of Phase-A as a reference. Using differential voltage probes for isolation, connect one input of the phase meter to Phase-B and the other input of the phase meter to Phase-A.

2. Send the following SCPI commands to the power source (200 VAC range selected):

```

INST:COUP ALL
OUTP 0
VOLT:SENSE EXT
VOLT:RANGE 200
VOLT 100
FREQ:MODE INT
FREQ 16
OUTP 1
INST:COUP NONE

```
3. Enter the calibration password with the SCPI command, CAL:PASS "5000".
4. Send the following SCPI commands to select Phase-A and set the phase to zero:

```

INST:SEL A
CAL:PHASE 0

```
5. Send the SCPI command, INST:SEL B, to select Phase-B.
6. Perform the alignment with the SCPI command, CAL:PHASE <numeric value>, where the numeric value is derived from phase measurement using the phase meter. Initially, set the phase to zero with the SCPI command, CAL:PHASE 0. Record the phase angle reading from the phase meter and then enter a numeric value of opposite polarity to the reading from the phase meter: e.g., if reading is +5°, enter -5°. Iteratively enter numeric values to produce the lowest phase reading. The phase might have to be incremented in steps of 0.2° to account for the phase resolution. Align for the lowest phase reading of < 0.5°.
7. Repeat Step-5 for output frequencies in the Master unit of 50 Hz, 100 Hz, 500 Hz, 1200 Hz, and 5000 Hz (with SCPI command, FREQ <n>), or the highest frequency of the particular power source model being aligned.

8. The calibration coefficients could be verified with the SCPI query, CAL:PHASE?. First cycle the AC input power off then on, and then send the command, CAL:PHASE?. The command will return a command-separated number sequence of calibration coefficients with the following format: f1,data1,f2,data2,f3,data3,f4,data4,f5,data5,f6,data6,current-cal.
9. Send the SCPI command, INST:SEL C, and repeat Step-6 through Step-8 to align Phase-C.
10. Reset Phase-B to 240°, Phase-C to 120°, and Phase-A to 0° with the following SCPI commands:

```
INST:NSEL B
PHASE 240
INST:NSEL C
PHASE 120
INST:NSEL A
PHASE 0
```

8.2.21 Alignment of External Programming Signal for Output Voltage Waveform/Amplitude

The external analog programming signals for setting the output voltage waveform/amplitude are available in the External Input/Output Control connector: Phase-A signal input at Pin-1; Phase-B signal input at Pin-2; Phase-C signal input at Pin-3; signal return at Pin-4 (refer to Section 3.12.1). The signal inputs have a dual function, and for this alignment they are selected for waveform/amplitude programming using the SCPI command, VOLT:REF EXT. The alignment is performed with a sine wave input: for example, a 0-10 V(PK) signal, which has an RMS range of 0-7.07 V(RMS), produces an output voltage that would vary from zero to full-scale of the selected output voltage range.

1. Connect the signal inputs for Phase-A (Pin-1), Phase-B (Pin-2), and Phase-C (Pin-3) together for connection to the same function generator output in Step-2.
2. Connect a function generator to External Input/Output Control connector signals at Pin-1/Pin-2/Pin-3 (signal) and Pin-4 (signal return); refer to Section 3.12.1. Set up the function generator to produce a sine wave output and set the output initially to zero.
3. Send the following SCPI commands to the power source (400 VAC range selected; ALC off; do not turn on the output at this time):

```
OUTP 0
MODE AC
VOLT:RANG 400
FREQ 100
VOLT:ALC OFF
VOLT:REF EXT
```
4. Enter the calibration password with the SCPI command, CAL:PASS "5000".
5. DC Offset alignment, high-range AC output (400 VAC):
6. Send the SCPI command, INST:SEL A, to select Phase-A.
7. Perform the DC offset alignment with the SCPI command, CAL:MEAS:EXT:OFFS:DC 0, with the output off and the external analog input at 0 VDC. Send the SCPI query command, *OPC?, to determine when this alignment step has been completed. Ensure alignment has completed (query returns a 1) before continuing.
8. Send the SCPI command, INST:SEL B, and repeat Step-7 to align Phase-B.
9. Send the SCPI command, INST:SEL C, and repeat Step-7 to align Phase-C.
10. Output Voltage AC Gain alignment, high-range AC output (400 VAC):
11. Send the SCPI command, INST:SEL A, to select Phase-A.
12. Send the SCPI command, VOLT REF FSC 10, to select the 10V range of the external programming AC signal. Apply an external sine wave AC voltage of 10.000 V(PK), ±0.005 V at 100 Hz.
13. Perform the output voltage AC gain alignment with the SCPI command, CAL:SOUR:EXT:FSC <numeric value>. The numeric value is in the range of 0 to 4095. Start with a value of 1500; increasing the value would increase the output voltage. Turn on the output with the SCPI command, OUTP 1. Adjust the numeric value with SCPI command,

- CAL:SOUR:EXT:FSC <numeric value>, for the closest setting producing an output voltage of 400 V(RMS).
14. Send the SCPI command, INST:SEL B, and repeat Step-12 and Step-13 to align Phase-B.
 15. Send the SCPI command, INST:SEL C, and repeat Step-12 and Step-13 to align Phase-C.
 16. Repeat Step-13 through Step-15 with an external programming AC sine wave input signal of 5.000 V(PK), ± 0.005 V and 2.500 V(PK), ± 0.005 V, using the SCPI commands, VOLT:REF:FSC 5.0 and VOLT:REF:FSC 2.5, respectively.
 17. ADC-RMS Full-Scale alignment, high-range AC output (400 VAC):
 18. Send the SCPI command, INST:SEL A, to select Phase-A.
 19. Select the 10 V range for the external programming signal with the SCPI command, VOLT:REF:FSC 10. Apply an external programming sine wave AC voltage of 10.000 V(PK), ± 0.005 V at 100 Hz.
 20. Perform the ADC-RMS gain alignment with the SCPI command, CAL:MEAS:EXT:FSC 400. Send the SCPI query command, *OPC?, to determine when this alignment step has been completed. Ensure alignment has completed (query returns a 1) before continuing. Verify the ADC-RMS measurement with the SCPI command, MEAS:VOLT:EXT?, and ensure that the returned output voltage value, 400 V(RMS), is within specification limits.
 21. Send the SCPI command, INST:SEL B, and repeat Step-19 and Step-20 to align Phase-B.
 22. Send the SCPI command, INST:SEL C, and repeat Step-19 and Step-20 to align Phase-C.
 23. Repeat Step-20 through Step-22 with an external programming AC sine wave input signal of 5.000 V(PK), ± 0.005 V and 2.500 V(PK), ± 0.005 V, using the SCPI commands, VOLT:REF:FSC 5.0 and VOLT:REF:FSC 2.5, respectively.

8.2.22 Alignment of External Programming Signal for Output Voltage Amplitude, DC Output

The external analog programming signals for setting the output voltage amplitude (RPV) are available in the External Input/Output Control connector: Phase-A signal input at Pin-1; Phase-B signal input at Pin-2; Phase-C signal input at Pin-3; signal return at Pin-4 (refer to Section 3.12.1). This signal inputs have a dual function, and for this alignment is selected for amplitude programming (RPV) using the SCPI command, VOLT:REF RPV. The alignment is performed with a DC input: for example, a 0-10 VDC signal would produce a DC output voltage that would vary from zero to full-scale of the selected output voltage range.

1. Connect the signal inputs for Phase-A (Pin-1), Phase-B (Pin-2), and Phase-C (Pin-3) together for connection to the same function generator output in Step-2.
2. Connect a DC reference voltage to External Input/Output Control connector Pin-1/Pin-2/Pin-3 (signal) and Pin-4 (signal return); refer to Section 3.12.1.
3. Send the following SCPI commands to the power source (500 VDC range selected; ALC is off; do not turn on the output at this time):

```
INST:COUP ALL
OUTP 0
MODE DC
VOLT:RANG 500
VOLT:ALC OFF
VOLT:REF RPV
INST:COUP NONE
```
4. Enter the calibration password with the SCPI command, CAL:PASS "5000".
5. DC Offset alignment, high-range DC output (500 VDC):
6. Send the SCPI command, INST:SEL A, to select Phase-A.
7. Perform the DC offset alignment for the selected phase with the SCPI command, CAL:MEAS:EXT:OFFS:DC 0, with the output off and the external analog input at 0 VDC. Send the SCPI query command, *OPC?, to determine when this alignment step has been completed; the query will return to a 1 to indicate completion. Ensure alignment has completed (query returns a 1) before continuing.
8. Send the SCPI command, INST:SEL B, and repeat Step-7 to align Phase-B.
9. Send the SCPI command, INST:SEL C, and repeat Step-7 to align Phase-C.

10. DC Gain alignment, high-range DC output (500 VDC):
11. Send the SCPI command, INST:SEL A, to select Phase-A.
12. Send the SCPI command, VOLT REF FSC 10, to select the 10V range of the external programming DC input signal. Apply an external DC voltage of 10.0 VDC, ± 0.005 V.
13. Perform the output voltage DC gain alignment with the SCPI command, CAL:SOUR:EXT:FSC <numeric value>. The numeric value is in the range of 0 to 4095. Start with a value of 1000; increasing the value would increase the output voltage. Turn on the output with the SCPI command, OUTP 1. Adjust the numeric value for the closest setting producing an output voltage of 500 VDC.
14. Send the SCPI command, INST:SEL B, and repeat Step-12 and Step-13 to align Phase-B.
15. Send the SCPI command, INST:SEL C, and repeat Step-12 and Step-13 to align Phase-C.
16. Repeat Step-13 through Step-15 with an external programming DC input signal of 5.0 VDC, ± 0.005 V and 2.5 VDC, ± 0.005 V, using the SCPI commands, VOLT:REF:FSC 5.0 and VOLT:REF:FSC 2.5, respectively.
17. ADC-RMS Full-Scale alignment, high-range DC output (500 VDC):
18. Send the SCPI command, INST:SEL A, to select Phase-A.
19. Send the SCPI command, VOLT REF FSC 10, to select the 10V range of the external programming DC input signal. Apply an external programming DC voltage of 10.0 VDC, ± 0.005 V.
20. Perform the ADC-RMS gain alignment with the SCPI command, CAL:MEAS:EXT:FSC 500. Send the SCPI query command, *OPC?, to determine when this alignment step has been completed; the query will return to a 1 to indicate completion. Ensure alignment has completed (query returns a 1) before continuing. Verify the measurement with the SCPI command, MEAS:VOLT:EXT?, and ensure that the returned output voltage value, 500 VDC, is within specification limits.
21. Send the SCPI command, INST:SEL B, and repeat Step-19 and Step-20 to align Phase-B.
22. Send the SCPI command, INST:SEL C, and repeat Step-19 and Step-20 to align Phase-C.
23. Repeat Step-20 through Step-22 with an external programming DC input signal of 5.0 VDC, ± 0.005 V and 2.5 VDC, ± 0.005 V, using the SCPI commands, VOLT:REF:FSC 5.0 and VOLT:REF:FSC 2.5, respectively.

8.2.23 Alignment of External Programming Signal for Output Voltage Amplitude, AC output

The external analog programming signals for setting the output voltage amplitude (RPV) are available in the External Input/Output Control connector: Phase-A signal input at Pin-1; Phase-B signal input at Pin-2; Phase-C signal input at Pin-3; signal return at Pin-4 (refer to Section 3.12.1). This signal input has a dual function, and for this alignment is selected for amplitude programming using the SCPI command, VOLT:REF RPV. The alignment is performed with a DC input: for example, a 0-10 VDC signal would control the AC output voltage amplitude from zero to full-scale of the selected output voltage range, while the AC output waveform is programmed through the internal reference generator.

1. Connect the signal inputs for Phase-A (Pin-1), Phase-B (Pin-2), and Phase-C (Pin-3) together for connection to the same function generator output in Step-2.
2. Connect a DC reference voltage to External Input/Output Control connector Pin-1/Pin-2/Pin-3 (signal) and Pin-4 (signal return (refer to Section 3.12.1)).
3. Send the following SCPI commands to the power source (400 VAC range selected; ALC off; do not turn on the output at this time):

```

INST:COUP ALL
OUTP 0
MODE AC
VOLT:RANG 400
FREQ 100
VOLT:ALC OFF
VOLT:REF RPV
INST:COUP NONE
      
```
4. Enter the calibration password with the SCPI command, CAL:PASS "5000".

5. DC Offset alignment, high-range AC output (400 VAC):
6. Send the SCPI command, INST:SEL A, to select Phase-A.
7. Perform the DC offset alignment with the SCPI command, CAL:MEAS:EXT:OFFS:DC 0, with the output off and the external analog input at 0 VDC. Send the SCPI query command, *OPC?, to determine when this alignment step has been completed; the query will return to a 1 to indicate completion. Ensure alignment has completed (query returns a 1) before continuing.
8. Send the SCPI command, INST:SEL B, and repeat Step-7 to align Phase-B.
9. Send the SCPI command, INST:SEL C, and repeat Step-7 to align Phase-C.
10. AC Gain alignment, high-range AC output (400 VAC):
11. Send the SCPI command, INST:SEL A, to select Phase-A.
12. Send the SCPI command, VOLT REF FSC 10, to select the 10V range of the external programming DC input signal. Apply an external programming DC voltage of 10.0 VDC, ± 0.005 V.
13. Perform the output voltage AC gain alignment with the SCPI command, CAL:SOUR:EXT:FSC <numeric value>. The numeric value is in the range of 0 to 4095. Start with a value of 1000; increasing the value would increase the output voltage. Turn on the output with the SCPI command, OUTP 1. Adjust the numeric value for the closest setting producing an output voltage of 400 V(RMS).
14. Send the SCPI command, INST:SEL B, and repeat Step-12 and Step-13 to align Phase-B.
15. Send the SCPI command, INST:SEL C, and repeat Step-12 and Step-13 to align Phase-C.
16. Repeat Step-12 through Step-15 with an external programming DC input signal of 5.0 VDC, ± 0.005 V and 2.5 VDC, ± 0.005 V, using the SCPI commands, VOLT:REF:FSC 5.0 and VOLT:REF:FSC 2.5, respectively.
17. ADC-RMS Full-Scale alignment, high-range AC output (400 VAC):
18. Send the SCPI command, INST:SEL A, to select Phase-A.
19. Send the SCPI command, VOLT REF FSC 10, to select the 10V range of the external programming DC input signal. Apply an external programming DC voltage of 10.0 VDC, ± 0.005 V.
20. Perform the ADC RMS gain alignment with the SCPI command, CAL:MEAS:EXT:FSC 400. Send the SCPI query command, *OPC?, to determine when this alignment step has been completed; the query will return to a 1 to indicate completion. Ensure alignment has completed (query returns a 1) before continuing. Verify the measurement with the SCPI command, MEAS:VOLT:EXT?, and ensure that the returned output voltage value, 400 V(RMS), is within specification limits.
21. Send the SCPI command, INST:SEL B, and repeat Step-19 and Step-20 to align Phase-B.
22. Send the SCPI command, INST:SEL C, and repeat Step-19 and Step-20 to align Phase-C.
23. Repeat Step-20 through Step-22 with an external programming DC input signal of 5.0 VDC, ± 0.005 V and 2.5 VDC, ± 0.005 V, using the SCPI commands, VOLT:REF:FSC 5.0 and VOLT:REF:FSC 2.5, respectively.
24. Cycle the AC input power off then on when calibration has been completed to terminate the alignment routines and have the calibration take effect.

8.2.24 Alignment of Inter-harmonics Output (413 Option Only)



WARNING!

This procedure requires access to the internal circuitry of the unit and exposes personnel to hazardous voltage and energy that could produce electrical shock. Care must be taken to avoid contact with the electrical circuits. Only authorized personnel should perform these procedures.

This alignment procedure should be performed after the output voltage measurement AC gain alignment of Section 8.2.5 has been done.

2. Remove the top cover of the unit by removing the three screws at the front edge of the cover, and the three screws at the rear, and then slide the cover towards the rear of the unit and lift.
Cycle the AC input power to the unit off then on.
4. Locate the AUX Generator PWA, part number 7003-719-1R (4.75" X 2.6" size), at the front, right-side of the unit, and horizontally mounted on the Master Controller PWA.
5. Locate potentiometer, R9, at the top edge (towards rear of the unit) of the AUX Generator PWA; refer to Figure 8-1. Potentiometers R10 and R11 are not used for the 1U, 1-Phase models.

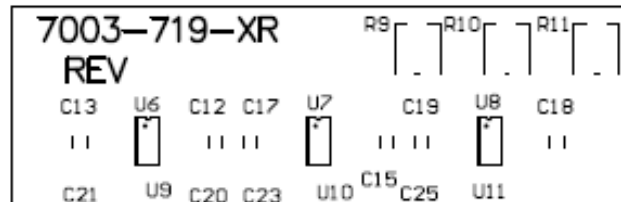

Figure 8-1. AUX Generator PWA Potentiometer, R9

6. Measure the output voltage of Phase-A, Phase-B and Phase-C with the power analyzer voltmeter.
7. Send the following SCPI commands to the power source to produce an inter-harmonics output of 20 VAC and 400 Hz:

```
IHAR ON
IHAR:COUP OFF
IHAR:REF 230
IHAR:VOLT 8.7
IHAR:FREQ 400
```
8. Align the inter-harmonics output voltage of Phase-A by adjusting R9 so that the measured output voltage is 20 VAC.
9. Align the inter-harmonics output voltage of Phase-B by adjusting R10 so that the measured output voltage is 20 VAC.
10. Align the inter-harmonics output voltage of Phase-C by adjusting R11 so that the measured output voltage is 20 VAC.
11. Cycle the AC input power off then on when calibration has been completed to terminate the alignment routines and have the calibration take effect.
12. For units with the LF and FC options:
13. Program the current output of Phase-A, Phase-B, and Phase-C to 0.3A using the SCPI command,

```
INST:COUP ALL
CURR 0.3
INST:COUP NONE
```
14. Set the inter-harmonics frequency to 1,800 Hz with the SCPI command, IHAR:FREQ 1800.
15. Enter the calibration password with the SCPI command, CAL:PASS "5000".
16. Perform the alignment of the inter-harmonics output voltage by using the SCPI command, CAL:IHAR <numeric value>. Iteratively send the command with numeric values so that the measured output voltage is 20 VAC. The numeric value could be in the range of ± 2000 , where the gain is increased by 1% for a count of 100.
17. Cycle the AC input power off then on when calibration has been completed to terminate the alignment routines and have the calibration take effect.

9. Service

9.1 Cleaning

Because the power source uses forced convection cooling, the air flow through the unit can pull in dust. In environments that have high concentrations of dust, periodic cleaning may be required. Disconnect AC mains power to the power source before cleaning. The exterior of the unit should be cleaned with a mild solution of detergent and water. The solution should be applied onto a soft cloth, and not directly to the surface of the unit. To prevent damage to materials, do not use aromatic hydrocarbons or chlorinated solvents for cleaning.

9.2 Basic Troubleshooting

Refer to the following tables for problems which might arise related to basic operation and connection of the power source.

9.2.1 Excessive Output Voltage

Cause	Solution
External leads are not connected (if selected).	Connect external sense wires to the rear panel AC/DC Output/Sense connector.
Voltage at the AC/DC Output connector is higher than that on Sense connector.	If the External Sense is connected to the load, the voltage output on Sense lines will be higher when the output is loaded because of output cable voltage drop.

9.2.2 Poor Output Voltage Regulation

Cause	Solution
Unit is overloaded and in constant-current mode.	Remove overload to allow constant-voltage operation.
Unit is programmed to wrong voltage range required for level of load current.	Select correct voltage range.
Remote Sense lines are not connected to load.	Connect Remote Sense lines to the load and select Remote Sense for the voltage sense method.

9.2.3 FAULT LED is On

Cause	Solution
Overcurrent (OCP) shutdown has occurred.	CV/CL mode is select; change to CV/CC; If excessive load current for current setpoint, reduce load current
ALC control error has occurred.	ALC is not able to regulate output; select REG or OFF mode; reduce output load.
Overtemperature (OTP) shutdown has occurred.	Ensure that the air intake and exhaust are not blocked, and that the ambient temperature at the power source air intake is within the specification range

9.2.4 Distorted Output

Cause	Solution
Load is drawing nonlinear currents.	Reduce load or add power sources in parallel group.
The crest factor of the load exceeds 5:1.	Reduce load current peaks by reducing load or adding power sources in parallel group.

9.2.5 Unit Shuts Down after Short Interval

Cause	Solution
Load has high inrush current and exceeds current setting in constant-voltage/current-limit mode.	Increase time delay for current-limit detection; add power sources in parallel group to increase output current capability.
Output is short-circuited.	Remove output short-circuit.
Remote sense leads are connected in reverse polarity	Correct sense wiring.

9.2.6 No Output and Front Panel Display/LEDs are Off.

Cause	Solution
Input AC mains are not connected.	Check mains disconnect switch.
There is no input AC mains power.	Verify that mains power is available.
The AC mains voltage is inadequate.	Verify that mains voltage is within specification limits.
If 1-phase input connection to the AC input mains, wiring incorrect to AC input connector.	Verify that correct terminals are used for 1-phase input mains connection.

9.2.7 No Output and Front Panel Display/LEDs are On

Cause	Solution
The OUTPUT switch is turned off.	Press OUTPUT switch and ensure that the OUTPUT LED is on.
Current setpoint is low or at zero.	Program current setpoint to higher value.
Voltage setpoint is low or at zero.	Program the correct output voltage.
REMOTE INHIBIT signal is shutting down the output.	Verify that the REMOTE INHIBIT signal is at the correct logic-level to enable the output.

9.2.8 Setting of AC/DC Mode or Voltage Range is Not Accepted

Cause	Solution
The OUTPUT switch is turned on.	Press OUTPUT switch to toggle output to off and ensure that the OUTPUT LED is off. Changes in setting of AC/DC Mode or Voltage Range could only be performed with the output off.

9.2.9 Parallel Group Faults When Master Output Switch is Turned On

Cause	Solution
Clock Config set to Auxiliary with Clock Mode set to SYNC.	With Clock Config set to Auxiliary, Clock Mode must be either Internal or External.

10. Error and Status Messages

Errors that occur during operation from either the front panel or the remote digital interface will result in error messages. Error messages are displayed on the front panel display and are also stored in memory allocated to the error message queue. The error messages in the queue could be read using the SCPI query command, SYST:ERR?. The error queue has a finite depth; if more error messages are generated than can be held in the queue, a queue overflow message will be put in the last queue location. To empty the queue, read out the error queue until the message, No Error, is received. Errors appearing on the front panel display have a negative number and will generally remain visible until the user moves to another screen. If multiple error messages are generated in succession, only the last message will be displayed.

Status message gives information on the operational state of the power source. They appear on the front panel with a positive number.

The table below displays a list of possible error and status messages along with their possible cause and remedy. Refer to the Asterion Programming Manual, M330100-01 (distributed on CD, CIC496) for more details. Refer to AMETEK Programmable Power website, www.programmablepower.com, to download latest version.

Number	Message String	Cause	Remedy
0	"No error"	No errors in queue	Normal operation
-100	"Command error"	Unable to complete requested operation	Check command syntax and data type.
-102	"Syntax error"	SCPI command syntax incorrect, unrecognized command or data type	Correct command syntax, e.g. misspelled or unsupported command.
-103	"Invalid separator"	SCPI command separator not recognized	Check SCPI section of Programming Manual.
-104	"Data type error"	Command data element invalid	Check command for supported data types.
-108	"Parameter not allowed"	One or more additional command parameters were received	Check Programming Manual for correct number of parameters.
-109	"Missing parameter"	Too few command parameters received for requested operation	Check Programming Manual for correct number of parameters.
-110	"Command header error"	Command header incorrect	Check syntax of command.
-111	"Header separator error"	Invalid command separator used.	Ensure that semi-colon is used to separate command headers.
-112	"Program mnemonic too long"	Command syntax error	Check Programming Manual for correct command syntax.
-113	"Undefined header"	Command not recognized error	Check Programming Manual for correct command syntax.
-120	"Numeric data error"	Data received is not a number	Check Programming Manual for correct command syntax.
-121	"Invalid character in number"	Number received contains non-numeric character(s)	Check Programming Manual for correct command syntax.
-123	"Exponent too large"	Number exponent exceeds limits	Check Programming Manual for correct command syntax.

Number	Message String	Cause	Remedy
-128	"Numeric data not allowed"	Number received, but is not allowed	Check Programming Manual for correct command syntax.
-168	"Block data not allowed"	Block data received, but is not allowed	Check Programming Manual for correct command syntax.
-200	"Execution error"	Command could not be executed	Command might be inconsistent with mode of operation, such as programming frequency when in DC-Mode.
-201	"Invalid while in local"	Command issued but unit is not in remote state	Put instrument in remote state before issuing SCPI commands.
-203	"Command protected"	Command is locked out	Some commands are supported by the unit but are locked out for protection of settings and are not user accessible.
-210	"Trigger error"	Problem with trigger system	Unit could not generate trigger for transient execution or measurement.
-211	"Trigger ignored"	Trigger request has been ignored	Trigger setup incorrect or unit was not armed when trigger was received. Check transient system or measurement trigger system settings.
-213	"Init ignored"	Initiation request has been ignored	Unit was told to go to armed state but was unable to do so. Could be caused by incorrect transient system or measurement acquisition setup.
-220	"Parameter error"	Parameter not allowed	Incorrect parameter or parameter value. Check Programming Manual for allowable parameters.
-221	"Setting conflict"	Requested setting conflicts with other settings in effect	Check settings: e.g., changing mode, AC/DC/AC+DC, is not allowed with output on; setting voltage is not allowed if reference is not internal; setting frequency is not allowed if set for External SYNC or Clock/Lock.
-222	"Data out of range"	Parameter data outside of allowable range	Check Programming Manual for allowable parameter values.
-223	"Too much data"	More data received than expected	Check Programming Manual for number of parameters or data block size.
-224	"Illegal parameter value"	Parameter value is not supported	Check Programming Manual for correct parameters.
-226	"Lists not same length"	One or more transient lists programmed have different length	All lists must be of same length or transient cannot be compiled and executed.
-254	"Media full"	No storage space left to save settings or data	Delete other settings or data to make room.
-255	"Directory full"	Too many waveform directory entries	Delete one or more waveforms from waveform memory to make room.
-256	"File name not found"	Waveform requested not in directory	Check waveform directory for waveform names present.
-257	"File name error"	Incorrect filename	Check waveform file definition for too many or non-ASCII characters.
-283	"Illegal variable name"	Variable name illegal	Use ASCII characters only.

Number	Message String	Cause	Remedy
-300	"Device specific error"	Hardware related generic error	Check settings for proper mode or command sequence: e.g., setting DC offset is not allowed if mode is not AC+DC; setting IEEE-488 address is not allowed if option is not installed; setting the state to on for the 411 option if the trigger sync source is not set to internal; changing remote sense is not allowed if output is on.
-311	"Memory error"	Waveform memory checksum error	Check for incomplete user-defined waveform download. Check interface and try downloading waveform again. Successful download may clear this error condition. Alternatively, use SCPI command, TRAC:DEL:ALL, to clear waveform memory.
-314	"Save/recall memory lost"	User setup register contents lost	Save setup again in same registers to restore content.
-315	"Configuration memory lost"	Hardware configuration settings lost	Contact AMETEK Service Department to obtain instructions on restoring configuration data.
-330	"Self-test failed"	Internal error	Contact AMETEK Service Department to troubleshoot problem.
-350	"Queue overflow"	Message queue full	Read status using SYST:ERR query until 0; "No Error" is received indicating queue empty.
-400	"Query error"	Unable to complete query.	Check Programming Manual for correct query format and parameters
-410	"Query INTERRUPTED"	Query issued but response not read	Check application program for correct flow. Response must be read after each query to avoid this error.
-420	"Query UNTERMINATED"	Query incomplete	Check for terminator after query command.
-430	"Query DEADLOCKED"	Query cannot be completed	Check application program for multiple queries.
-440	"Query UNTERMINATED"	Query incomplete.	Check for terminator after query command.
1	"Output volt fault"	Output voltage does not match programmed value	Reduce load or increase current setpoint. Also, output voltage might be driven above programmed voltage by external influence (load voltage kickback, etc.).
2	"Current limit fault"	Current limit exceeded	Load exceeds current limit (CL) programmed value; reduce load or increase CL setting. Change to constant-current mode (CC).
3	"Temperature fault"	Internal module temperature too high	Reduce load. Ensure proper air flow and exhaust clearance. Check fans for operation.
4	"External sync. error"	Could not sync to external sync signal	External sync signal missing, disconnected or out of range.
5	"Initial memory lost"	Power-on settings could not be recalled.	Save power-on settings again to overwrite old content.

Number	Message String	Cause	Remedy
6	"Limit memory lost"	Hardware configuration settings lost	Contact AMETEK Service Department to obtain instructions on restoring configuration data.
7	"System memory lost"	Memory corrupted	Recycle power. Contact AMETEK Service Department for instructions if memory remains corrupted.
8	"Calibration memory lost"	Calibration data lost	Contact AMETEK Service Department to obtain instructions on restoring calibration data or recalibration unit.
9	"Start angle must be first sequence"	Start phase angle in wrong place	Start phase angles can only be programmed at the start of a transient list. Once a transient is in progress, phase angle cannot be changed.
10	"Illegal for DC"	Operation not possible in DC-Mode	Switch to AC or AC+DC mode.
13	"Missing list parameter"	One or more transient list parameters missing	Check programmed lists.
14	"Voltage peak error "	Peak voltage exceeded	This error could occur when selecting user-defined wave shapes with higher crest factors. Reduce programmed RMS value.
16	"Illegal during transient"	Operation requested not available while transient is running	Wait until transient execution is completed or abort transient execution first.
17	"Output relay must be closed"	Operation not possible with open relay	Close relay before attempting operation: e.g., transient execution requires output relay to be closed.
18	"Trans. duration less than 0.5msec"	Dwell time below minimum of 0.5 ms	Increase dwell time to at least 0.5 ms.
19	"Clock and sync must be internal"	Operation not possible with external clock	Switch to internal sync (default).
20	"Input buffer full"	Too much data received	Break up data in smaller blocks.
21	"Timeout error"	Controller did not receive command from the display	Reduce remote command activity. Internal communication between controller and display has been impacted.
22	"Waveform harmonics limit"	Harmonic content of user-defined wave shape is too high for amplifier capability	Reduce harmonic content or reduce the programmed fundamental frequency.
24	"Output relay must be open"	Attempting to change settings that expect relay to be closed	Ensure that the output relay is open when changing settings such as range, sense, and AC/DC/AC+DC mode.
25	"Overvoltage Protection Trip"	Overvoltage limit exceeded	Ensure that OVP is programmed sufficiently above output voltage value. Check for load inductive kickbacks or overshoot on output. Ensure that remote sense leads are connected, if utilized.
29	"DC component exceeds limit"	Waveform selected contains a DC component that is not possible in the AC-Mode	Select AC+DC mode.

Number	Message String	Cause	Remedy
30	"Dc bus fault"	DC Module is not producing proper voltage	Verify that external ambient temperature is not greater than 40°C. Contact AMETEK Service Department for instructions pertaining to internal hardware fault.
31	"Pfc bus fault"	PFC Module is not producing proper voltage	Verify that the AC input voltage is adequate for the output power; refer to specifications section. Verify that external ambient temperature is not greater than 40°C. Contact AMETEK Service Department for instructions pertaining to internal hardware fault.
32	"Ac module error"	AC Module is not able to produce output power	Verify that external ambient temperature is not greater than 40°C. Contact AMETEK Service Department for instructions pertaining to internal hardware fault.
33	"External reference exceeds limit"	Amplitude or frequency of the external programming signal exceeds allowed limits	Ensure that external programming signal meets specification requirements.

Table 10-1. Error and Status Messages

Index

4

411 Option	29
413 Option	29

A

AC Input	
1-phase operation	40
3-phase operation	40
safety disconnect device	39
safety ground stud	39
AC/DC Output	
connector	41, 42
functional ground	41
Accessories	31
Acoustic Noise	24
Add Menu	86
ALC	75
AMD Option	29
Analog Menu	106
APPLICATIONS Screen	111, 112
AVALL Option	29
AVSTD Option	29

B

B787 Option	29
Basic Operation	60
Bench-Top Use	32

C

Calibration	
equipment	135
external alignment, AC amplitude	150
external programming alignment, AC output amplitude	150
external programming alignment, DC output amplitude	149
external programming alignment, waveform/amplitude	148
interharmonics output, 413 option	151
measurement gain alignment, AC current high-range	140
measurement gain alignment, AC current low-range	139
measurement gain alignment, AC voltage	138
measurement gain alignment, DC negative current high-range	143
measurement gain alignment, DC negative current low-range	143
measurement gain alignment, DC positive current high-range	142

measurement gain alignment, DC positive current low-range	142
measurement gain alignment, negative DC voltage	139
measurement gain alignment, positive DC voltage	138
measurement offset alignment, AC current low-range	141
measurement offset alignment, DC current high-range	145
measurement offset alignment, DC current low-range	144
phase alignment, Auxiliary to Master	146
phase alignment, external SYNC	146
phase alignment, Phase-B/Phase-C to Phase-A	147
procedures	135
zero alignment, AC	136
zero alignment, DC	152
Cleaning	153
Clock and Lock Connectors	50
Command Monitor Connector	50
CONFIGURATION Screen	98
Constant-Power Mode	18
output characteristic	63
CONTROL INTERFACE Screen	106

D

DASHBOARD Screen	69
real-time adjustment	70
Default Screen	71, 100

E

External Input/Output Connector	46
External Interface Connector	49

F

Frequency Surge/Sag Menu	93
Frequency Sweep/Step Menu	92
Front Panel Controls/Indicators, ATE	59
Front Panel Controls/Indicators, Enhanced	58
Front Panel Display	
keypad	65
navigating	63
touch-screen	63
Front Panel View	57
Functional Test	61

G

GPIO Menu	108
-----------------	-----

H	
Harmonics Menu	79
HOME Screen	68
I	
IEEE-488 Option	28
L	
LAN.....	28
LAN Connector.....	54
LAN Menu	108
LCD Calibration Menu.....	115
Local Sense.....	43
M	
Master and Auxiliary Connectors	51
MC Option	29
Measurements	
advanced	122
fast Fourier transform (FFT)	122
standard	121
trigger mode.....	125
trigger source.....	125
MEASUREMENTS Screen.....	76
Messages	155
Models, Asterion Series	14
Multi-Phase Group	55
N	
Noise Pickup, Wiring	43
O	
Outline Drawings	35
OUTPUT PROGRAM Screen	71
Output Voltage Sensing	
local sense.....	43
remote sense	43
P	
Parallel Group	55
Protection	
AC input overcurrent.....	39
Protective covers.....	35
R	
Rackmount Installation	33
Rear Panel Connectors	
AC input	28
AC/DC output.....	28
AC/DC remote sense.....	28
Auxiliary Interface	28
clock and lock	50
Clock and Lock	28
command monitor	50
external input/output	46
External Input/Output Control	28
external interface.....	49
External Interface	28
functional ground.....	28
IEEE-488 interface.....	28
LAN	54
LAN interface	28
master and auxiliary.....	51
Master Interface	28
RS-232C	52
RS-232C interface.....	28
safety ground	28
trigger input	50
Trigger Output.....	28
USB	53
USB interface	28
Rear Panel View	38
Regulation Menu.....	74, 75
Reliability	26
Remote Inhibit Signal.....	49
Remote Sense	43
Rotary Encoder.....	65
RS232 Menu	107
RS-232C	28
RS-232C Connector	52
Run Menu	97
S	
Setting Menu.....	82
Ship Kit	31
Software Options	
411	29
413	29
AMD	29
AVALL	29
AVSTD	29
B787	29
Summary Fault Signal (DFI).....	48
SYSTEM SETTING Screen.....	113
T	
Transient Programming	129
list execution	133
list transients	131
saving list	134
TRANSIENTS Screen.....	82
Trigger Input Connector.....	50
Troubleshooting	153
U	
USB.....	28
USB Connector.....	53
V	
View Menu	85
Volt/Freq Delay Menu	96

Volt/Freq Surge/Sag Menu	95	frequency restriction	119
Volt/Freq Sweep/Step Menu.....	94	maximum RMS	118
Voltage Drop Menu	89	standard.....	117
Voltage Surge/Sag Menu	91	transient list	119
Voltage Sweep/Step Menu	90	Viewing custom-defined	118
W		Wire Size.....	44
Waveform Menu	74	X	
Waveforms		XLOAD	100
custom-defined.....	117		

